



**NEC**

**SPC BENCHMARK 1™  
FULL DISCLOSURE REPORT**

**NEC CORPORATION  
NEC STORAGE M310**

**SPC-1 V1.14**

**Submitted for Review: March 7, 2016  
Submission Identifier: A00169**

**First Edition – March 2016**

THE INFORMATION CONTAINED IN THIS DOCUMENT IS DISTRIBUTED ON AN AS IS BASIS WITHOUT ANY WARRANTY EITHER EXPRESS OR IMPLIED. The use of this information or the implementation of any of these techniques is the customer's responsibility and depends on the customer's ability to evaluate and integrate them into the customer's operational environment. While each item has been reviewed by NEC Corporation for accuracy in a specific situation, there is no guarantee that the same or similar results will be obtained elsewhere. Customers attempting to adapt these techniques to their own environment do so at their own risk.

This publication was produced in the United States. NEC Corporation may not offer the products, services, or features discussed in this document in other countries, and the information is subject to change with notice. Consult your local NEC Corporation representative for information on products and services available in your area.

© Copyright NEC Corporation 2016. All rights reserved.

Permission is hereby granted to reproduce this document in whole or in part, provided the copyright notice as printed above is set forth in full text on the title page of each item reproduced.

**Trademarks**

SPC Benchmark-1, SPC-1, SPC-1 IOPS, SPC-1 LRT and SPC-1 Price-Performance are trademarks of the Storage Performance Council. NEC and the NEC logo are trademarks or registered trademarks of NEC Corporation in the United States and other countries. All other brands, trademarks, and product names are the property of their respective owners.

## Table of Contents

<b>Audit Certification</b> .....	<b>vii</b>
<b>Audit Certification (<i>cont.</i>)</b> .....	<b>viii</b>
<b>Letter of Good Faith</b> .....	<b>ix</b>
<b>Executive Summary</b> .....	<b>10</b>
<b>Test Sponsor and Contact Information</b> .....	<b>10</b>
<b>Revision Information and Key Dates</b> .....	<b>10</b>
<b>Tested Storage Product (TSP) Description</b> .....	<b>11</b>
<b>Summary of Results</b> .....	<b>12</b>
<b>Storage Capacities, Relationships, and Utilization</b> .....	<b>13</b>
<b>Response Time – Throughput Curve</b> .....	<b>16</b>
<b>Response Time – Throughput Data</b> .....	<b>16</b>
<b>Priced Storage Configuration Pricing</b> .....	<b>17</b>
<b>Differences between the Tested Storage Configuration (TSC) and Priced Storage Configuration</b> .....	<b>18</b>
<b>Priced Storage Configuration Diagram</b> .....	<b>19</b>
<b>Priced Storage Configuration Components</b> .....	<b>20</b>
<b>Configuration Information</b> .....	<b>21</b>
<b>Benchmark Configuration (BC)/Tested Storage Configuration (TSC) Diagram</b> .....	<b>21</b>
<b>Storage Network Configuration</b> .....	<b>21</b>
<b>Host System(s) and Tested Storage Configuration (TSC) Table of Components</b> .....	<b>21</b>
<b>Benchmark Configuration/Tested Storage Configuration Diagram</b> .....	<b>22</b>
<b>Host System and Tested Storage Configuration Components</b> .....	<b>23</b>
<b>Customer Tunable Parameters and Options</b> .....	<b>24</b>
<b>Tested Storage Configuration (TSC) Description</b> .....	<b>24</b>
<b>SPC-1 Workload Generator Storage Configuration</b> .....	<b>24</b>
<b>ASU Pre-Fill</b> .....	<b>25</b>
<b>SPC-1 Data Repository</b> .....	<b>26</b>
<b>Storage Capacities and Relationships</b> .....	<b>26</b>
SPC-1 Storage Capacities .....	<b>26</b>
SPC-1 Storage Hierarchy Ratios .....	<b>27</b>
SPC-1 Storage Capacity Charts .....	<b>27</b>
<b>Storage Capacity Utilization</b> .....	<b>29</b>
<b>Logical Volume Capacity and ASU Mapping</b> .....	<b>30</b>
<b>SPC-1 Benchmark Execution Results</b> .....	<b>31</b>
<b>SPC-1 Tests, Test Phases, and Test Runs</b> .....	<b>31</b>

<b>“Ramp-Up” Test Runs.....</b>	<b>32</b>
<b>Primary Metrics Test – Sustainability Test Phase .....</b>	<b>32</b>
SPC-1 Workload Generator Input Parameters .....	33
Sustainability Test Results File .....	33
Sustainability – Data Rate Distribution Data (MB/second) .....	33
Sustainability – Data Rate Distribution Graph .....	33
Sustainability – I/O Request Throughput Distribution Data .....	34
Sustainability – I/O Request Throughput Distribution Graph .....	34
Sustainability – Average Response Time (ms) Distribution Data .....	35
Sustainability – Average Response Time (ms) Distribution Graph .....	35
Sustainability – Response Time Frequency Distribution Data .....	36
Sustainability – Response Time Frequency Distribution Graph .....	36
Sustainability – Measured Intensity Multiplier and Coefficient of Variation.....	37
<b>Primary Metrics Test – IOPS Test Phase.....</b>	<b>38</b>
SPC-1 Workload Generator Input Parameters .....	38
IOPS Test Results File.....	38
IOPS Test Run – I/O Request Throughput Distribution Data .....	39
IOPS Test Run – I/O Request Throughput Distribution Graph.....	39
IOPS Test Run – Average Response Time (ms) Distribution Data .....	40
IOPS Test Run – Average Response Time (ms) Distribution Graph .....	40
IOPS Test Run –Response Time Frequency Distribution Data .....	41
IOPS Test Run –Response Time Frequency Distribution Graph.....	41
IOPS Test Run – I/O Request Information.....	42
IOPS Test Run – Measured Intensity Multiplier and Coefficient of Variation .....	42
<b>Primary Metrics Test – Response Time Ramp Test Phase .....</b>	<b>43</b>
SPC-1 Workload Generator Input Parameters .....	43
Response Time Ramp Test Results File.....	43
Response Time Ramp Distribution (IOPS) Data.....	44
Response Time Ramp Distribution (IOPS) Data ( <i>continued</i> ) .....	45
Response Time Ramp Distribution (IOPS) Graph .....	45
SPC-1 LRT™ Average Response Time (ms) Distribution Data.....	46
SPC-1 LRT™ Average Response Time (ms) Distribution Graph .....	46
SPC-1 LRT™ (10%) – Measured Intensity Multiplier and Coefficient of Variation .....	47
<b>Repeatability Test .....</b>	<b>48</b>
SPC-1 Workload Generator Input Parameters .....	48
Repeatability Test Results File .....	49
Repeatability 1 LRT – I/O Request Throughput Distribution Data.....	50
Repeatability 1 LRT – I/O Request Throughput Distribution Graph .....	50
Repeatability 1 LRT –Average Response Time (ms) Distribution Data .....	51

Repeatability 1 LRT –Average Response Time (ms) Distribution Graph.....	51
Repeatability 1 IOPS – I/O Request Throughput Distribution Data .....	52
Repeatability 1 IOPS – I/O Request Throughput Distribution Graph.....	52
Repeatability 1 IOPS –Average Response Time (ms) Distribution Data.....	53
Repeatability 1 IOPS –Average Response Time (ms) Distribution Graph .....	53
Repeatability 2 LRT – I/O Request Throughput Distribution Data.....	54
Repeatability 2 LRT – I/O Request Throughput Distribution Graph .....	54
Repeatability 2 LRT –Average Response Time (ms) Distribution Data .....	55
Repeatability 2 LRT –Average Response Time (ms) Distribution Graph.....	55
Repeatability 2 IOPS – I/O Request Throughput Distribution Data .....	56
Repeatability 2 IOPS – I/O Request Throughput Distribution Graph.....	56
Repeatability 2 IOPS –Average Response Time (ms) Distribution Data.....	57
Repeatability 2 IOPS –Average Response Time (ms) Distribution Graph .....	57
Repeatability 1 (LRT) Measured Intensity Multiplier and Coefficient of Variation .....	58
Repeatability 1 (IOPS) Measured Intensity Multiplier and Coefficient of Variation .....	58
Repeatability 2 (LRT) Measured Intensity Multiplier and Coefficient of Variation .....	58
Repeatability 2 (IOPS) Measured Intensity Multiplier and Coefficient of Variation .....	59
<b>Data Persistence Test.....</b>	<b>60</b>
SPC-1 Workload Generator Input Parameters .....	60
Data Persistence Test Results File .....	60
Data Persistence Test Results.....	61
<b>Priced Storage Configuration Availability Date.....</b>	<b>62</b>
<b>Pricing Information.....</b>	<b>62</b>
<b>Tested Storage Configuration (TSC) and Priced Storage Configuration Differences.....</b>	<b>62</b>
<b>Anomalies or Irregularities .....</b>	<b>62</b>
<b>Appendix A: SPC-1 Glossary .....</b>	<b>63</b>
“Decimal” ( <i>powers of ten</i> ) Measurement Units.....	63
“Binary” ( <i>powers of two</i> ) Measurement Units.....	63
SPC-1 Data Repository Definitions.....	63
SPC-1 Data Protection Levels .....	64
SPC-1 Test Execution Definitions .....	64
I/O Completion Types .....	66
SPC-1 Test Run Components.....	66
<b>Appendix B: Customer Tunable Parameters and Options.....</b>	<b>67</b>
<b>Appendix C: Tested Storage Configuration (TSC) Creation .....</b>	<b>68</b>
<b>Telnet Login and Enter Maintenance Mode .....</b>	<b>68</b>

<b>Create Volume Group (Pools)</b> .....	<b>68</b>
<b>Create Logical Disks</b> .....	<b>70</b>
<b>Exit Maintenance Mode and Telnet Logoff</b> .....	<b>70</b>
<b>SPC-1 Logical Volume Creation</b> .....	<b>71</b>
<b>Appendix D: SPC-1 Workload Generator Storage Commands and Parameters</b> .....	<b>72</b>
<b>ASU Pre-Fill</b> .....	<b>72</b>
<b>Primary Metrics and Repeatability Tests</b> .....	<b>72</b>
<b>SPC-1 Persistence</b> .....	<b>72</b>
<b>Slave JVMs</b> .....	<b>72</b>
<b>Appendix E: SPC-1 Workload Generator Input Parameters</b> .....	<b>73</b>
<b>Slave JVMs</b> .....	<b>73</b>
start_slave_7.bat .....	73
ns61_sl.parm.....	74
<b>master_script_M310.bat</b> .....	<b>74</b>
<b>ASU Pre-Fill</b> .....	<b>74</b>
prepssd.bat .....	74
<b>TSC Power Off</b> .....	<b>75</b>
shutdown.bat .....	75
M310_shutdown.ttl .....	75
<b>SPC-1 Persistence Test Run 2 (read phase)</b> .....	<b>76</b>
master_script_2_M310.bat .....	76

## AUDIT CERTIFICATION



Kentaro Yamamoto  
 NEC Corporation  
 1-10, Nisshin-Cho, Fuchu  
 Tokyo, 183-8501, Japan

March 6, 2016

The SPC Benchmark 1™ Reported Data listed below for the NEC Storage M310 was produced in compliance with the SPC Benchmark 1™ v1.14 Remote Audit requirements.

SPC Benchmark 1™ v1.14 Reported Data	
Tested Storage Product (TSP) Name: NEC Storage M310	
Metric	Reported Result
SPC-1 IOPS™	131,986.51
SPC-1 Price-Performance	\$2.54/SPC-1 IOPS™
Total ASU Capacity	65,970.603 GB
Data Protection Level	Protected 2 (Mirroring)
Total Price (including three-year maintenance)	\$335,139.15
Currency Used	U.S. Dollars
Target Country for availability, sales and support	USA

The following SPC Benchmark 1™ Remote Audit requirements were reviewed and found compliant with 1.14 of the SPC Benchmark 1™ specification:

- A Letter of Good Faith, signed by a senior executive.
- The following Data Repository storage items were verified by information supplied by NEC Corporation:
  - ✓ Physical Storage Capacity and requirements.
  - ✓ Configured Storage Capacity and requirements.
  - ✓ Addressable Storage Capacity and requirements.
  - ✓ Capacity of each Logical Volume and requirements.
  - ✓ Capacity of each Application Storage Unit (ASU) and requirements.
- The total Application Storage Unit (ASU) Capacity was filled with random data, using an auditor approved tool, prior to execution of the SPC-1 Tests.

Storage Performance Council  
 643 Bair Island Road, Suite 103  
 Redwood City, CA 94062  
[AuditService@storageperformance.org](mailto:AuditService@storageperformance.org)  
 650.556.9384

## AUDIT CERTIFICATION (CONT.)

NEC Storage M310  
SPC-1 Audit Certification

Page 2

- An appropriate diagram of the Benchmark Configuration (BC)/Tested Storage Configuration (TSC).
- Listings and commands to configure the Benchmark Configuration/Tested Storage Configuration, including customer tunable parameters that were changed from default values.
- SPC-1 Workload Generator commands and parameters used for the audited SPC Test Runs.
- The following Host System requirements were verified by information supplied by NEC Corporation:
  - ✓ The type of Host Systems including the number of processors and main memory.
  - ✓ The presence and version number of the SPC-1 Workload Generator on each Host System.
  - ✓ The TSC boundary within each Host System.
- The execution of each Test, Test Phase, and Test Run was found compliant with all of the requirements and constraints of Clauses 4, 5, and 11 of the SPC-1 Benchmark Specification.
- The Test Results Files and resultant Summary Results Files received from NEC Corporation for each of following were authentic, accurate, and compliant with all of the requirements and constraints of Clauses 4 and 5 of the SPC-1 Benchmark Specification:
  - ✓ Data Persistence Test
  - ✓ Sustainability Test Phase
  - ✓ IOPS Test Phase
  - ✓ Response Time Ramp Test Phase
  - ✓ Repeatability Test
- There were no differences between the Tested Storage Configuration (TSC) and Priced Storage Configuration.
- The submitted pricing information met all of the requirements and constraints of Clause 8 of the SPC-1 Benchmark Specification.
- The Full Disclosure Report (FDR) met all of the requirements in Clause 9 of the SPC-1 Benchmark Specification.
- This successfully audited SPC measurement is not subject to an SPC Confidential Review.

**Audit Notes:**

There were no audit notes or exceptions.

Respectfully,

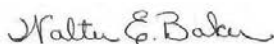

Walter E. Baker  
SPC Auditor

Storage Performance Council  
643 Bair Island Road, Suite 103  
Redwood City, CA 94062  
[AuditService@storageperformance.org](mailto:AuditService@storageperformance.org)  
650.556.9384



**LETTER OF GOOD FAITH**

NEC Corporation  
1-10, Nisshin-Cho, Fuchu, Tokyo 183-8501, Japan

Date: March 2, 2016

From: NEC Corporation

To: Walter E. Baker, SPC Auditor  
Storage Performance Council (SPC)  
643 Bair Island Road, Suite 103  
Redwood City, CA 94063-2755

Subject: SPC-1 Letter of Good Faith for the NEC Storage M310

NEC Corporation is the SPC-1 Test Sponsor for the above listed product. To the best of our knowledge and belief, the required SPC-1 benchmark results and materials we have submitted for that product are complete, accurate, and in full compliance with V1.14 of the SPC-1 benchmark specification.

In addition, we have reported any items in the Benchmark Configuration and execution of the benchmark that affected the reported results even if the items are not explicitly required to be disclosed by the SPC-1 benchmark specification.

Signed:

Date:

Tsuneo Kurachi

2nd, March, 2016

Tsuneo Kurachi  
Chief Manager  
7th IT Platform Department  
IT Platform Division

## EXECUTIVE SUMMARY

### Test Sponsor and Contact Information

Test Sponsor and Contact Information	
<b>Test Sponsor Primary Contact</b>	NEC Corporation – <a href="http://www.nec.com">http://www.nec.com</a> Kentaro Yamamoto – <a href="mailto:k-yamamoto@dh.jp.nec.com">k-yamamoto@dh.jp.nec.com</a> 1-10, Nisshin-Cho, Fuchu Tokyo, 183-8501, Japan Phone: +81 42 333 5150
<b>Test Sponsor Alternate Contact</b>	NEC Corporation – <a href="http://www.nec.com">http://www.nec.com</a> Yoshifumi Yamaguchi – <a href="mailto:y-yamaguchi@dc.jp.nec.com">y-yamaguchi@dc.jp.nec.com</a> 1-10, Nisshin-Cho, Fuchu Tokyo, 183-8501, Japan Phone: +81 42 333 1710 FAX: +81 42 333 1777
<b>Test Sponsor Alternate Contact</b>	NEC Corporation of America – <a href="http://www.necam.com/">http://www.necam.com/</a> Chauncey Schwartz – <a href="mailto:chauncey.schwartz@necam.com">chauncey.schwartz@necam.com</a> 2880 Scott Blvd. Santa Clara, CA 95050 Phone: (952) 388-8466
<b>Auditor</b>	Storage Performance Council – <a href="http://www.storageperformance.org">http://www.storageperformance.org</a> Walter E. Baker – <a href="mailto:AuditService@StoragePerformance.org">AuditService@StoragePerformance.org</a> 643 Bair Island Road, Suite 103 Redwood City, CA 94063 Phone: (650) 556-9384 FAX: (650) 556-9385

### Revision Information and Key Dates

Revision Information and Key Dates	
<b>SPC-1 Specification revision number</b>	V1.14
<b>SPC-1 Workload Generator revision number</b>	V2.3.0
<b>Date Results were first used publicly</b>	March 7, 2016
<b>Date the FDR was submitted to the SPC</b>	March 7, 2016
<b>Date the Priced Storage Configuration is available for shipment to customers</b>	currently available
<b>Date the TSC completed audit certification</b>	March 6, 2016

**Tested Storage Product (TSP) Description**

The NEC M310 SAN disk array has the high performance, capacity and availability demanded by data-intensive, mission critical environments.

With a straightforward navigational GUI, systems administrators can easily modify settings and capacity, and monitor disk performance. Equipped with 48GB of cache, the M310 storage solution simultaneously supports DDRs, SSDs, Nearline SAS and traditional SAS HDDs in the same enclosure, enabling flexible tiered storage architecture.

Ideal for use in any virtualized datacenter with its flexibility for scaling and support with VMware APIs.

## Summary of Results

SPC-1 Reported Data	
Tested Storage Product (TSP) Name: NEC Storage M310	
Metric	Reported Result
SPC-1 IOPS™	131,986.51
SPC-1 Price-Performance™	\$2.54/SPC-1 IOPS™
Total ASU Capacity	65,970.603 GB
Data Protection Level	Protected 2 ( <i>Mirroring</i> )
Total Price	\$335,139.15
Currency Used	U.S. Dollars
Target Country for availability, sales and support	USA

SPC-1 IOPS™ represents the maximum I/O Request Throughput at the 100% load point.

SPC-1 Price-Performance™ is the ratio of **Total Price** to SPC-1 IOPS™.

**Total ASU** (Application Storage Unit) **Capacity** represents the total storage capacity available to be read and written in the course of executing the SPC-1 benchmark.

A **Data Protection Level** of **Protected 2** using *Mirroring* configures two or more identical copies of user data.

***Protected 2:** The single point of failure of any **component** in the configuration will not result in permanent loss of access to or integrity of the SPC-1 Data Repository.*

**Total Price** includes the cost of the Priced Storage Configuration plus three years of hardware maintenance and software support as detailed on page 17.

**Currency Used** is formal name for the currency used in calculating the **Total Price** and **SPC-1 Price-Performance™**. That currency may be the local currency of the **Target Country** or the currency of a difference country (*non-local currency*).

The **Target Country** is the country in which the Priced Storage Configuration is available for sale and in which the required hardware maintenance and software support is provided either directly from the Test Sponsor or indirectly via a third-party supplier.

### Storage Capacities, Relationships, and Utilization

The following four charts and table document the various storage capacities, used in this benchmark, and their relationships, as well as the storage utilization values required to be reported.

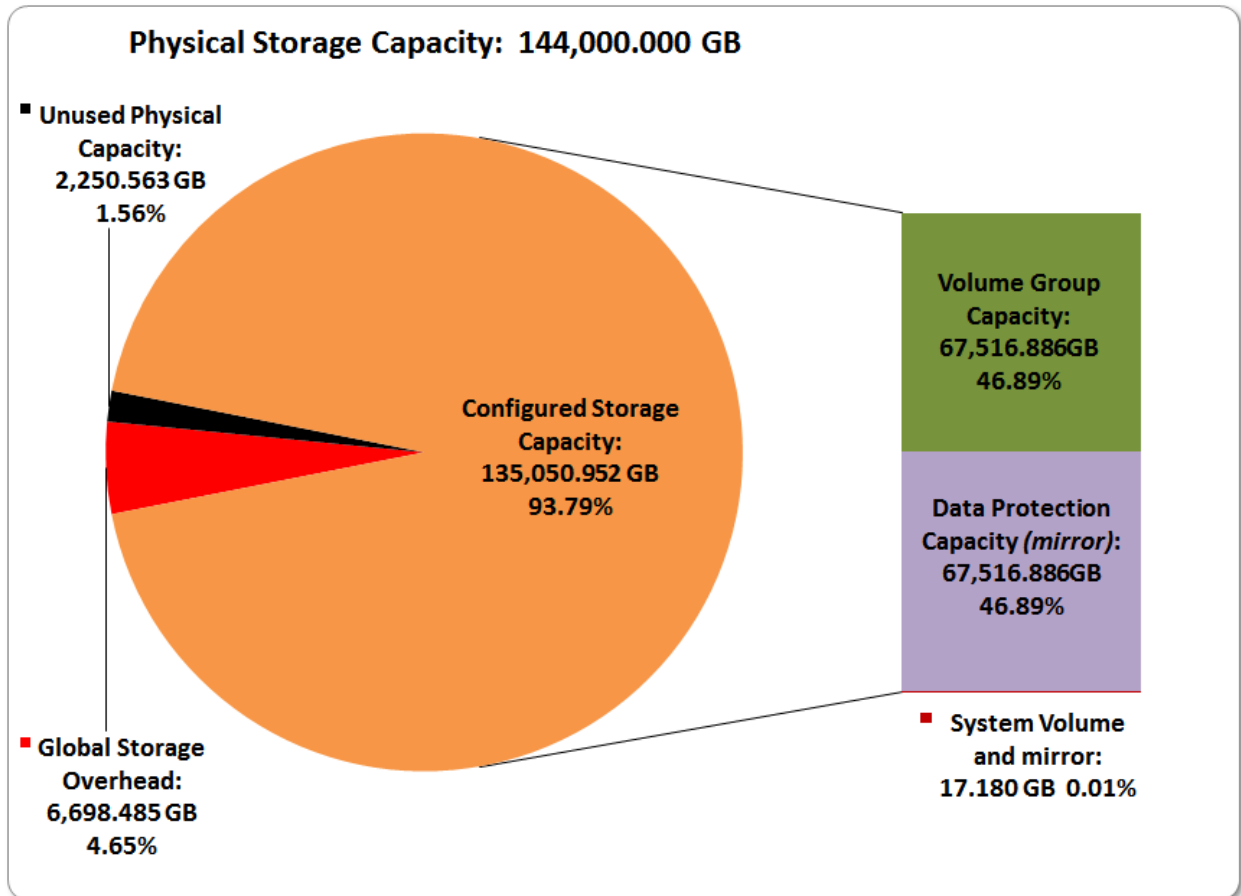

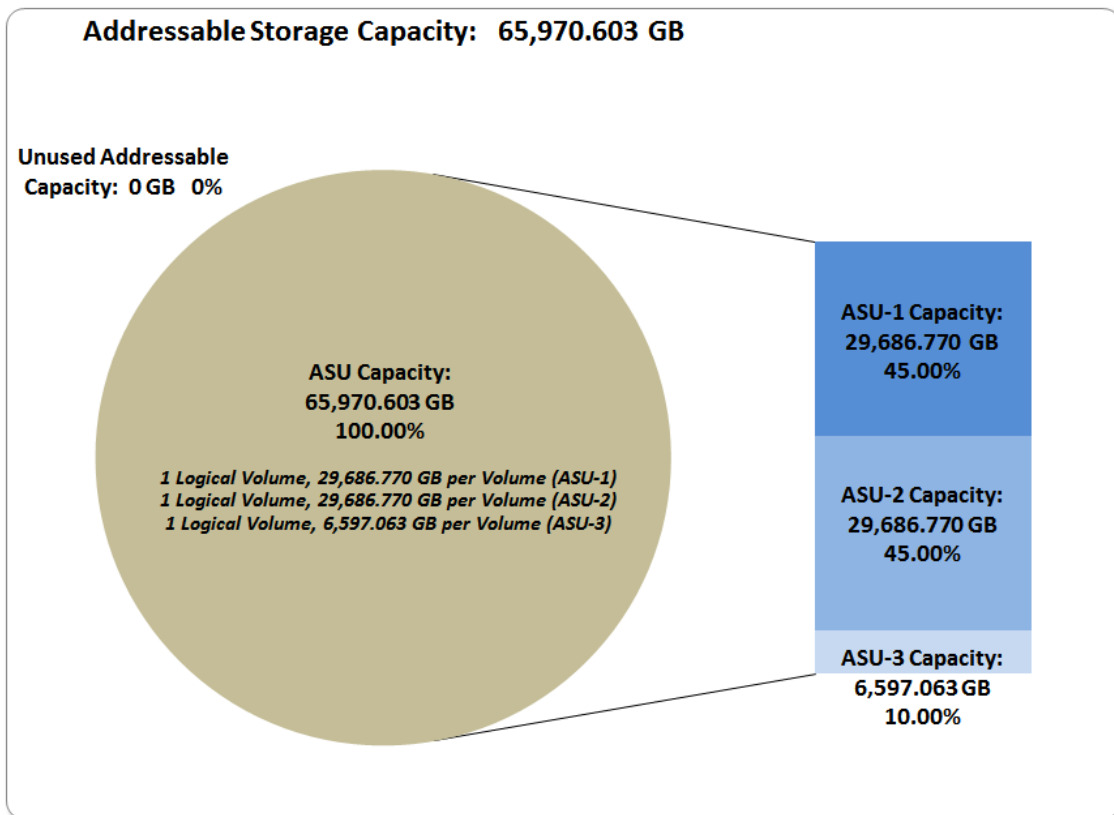
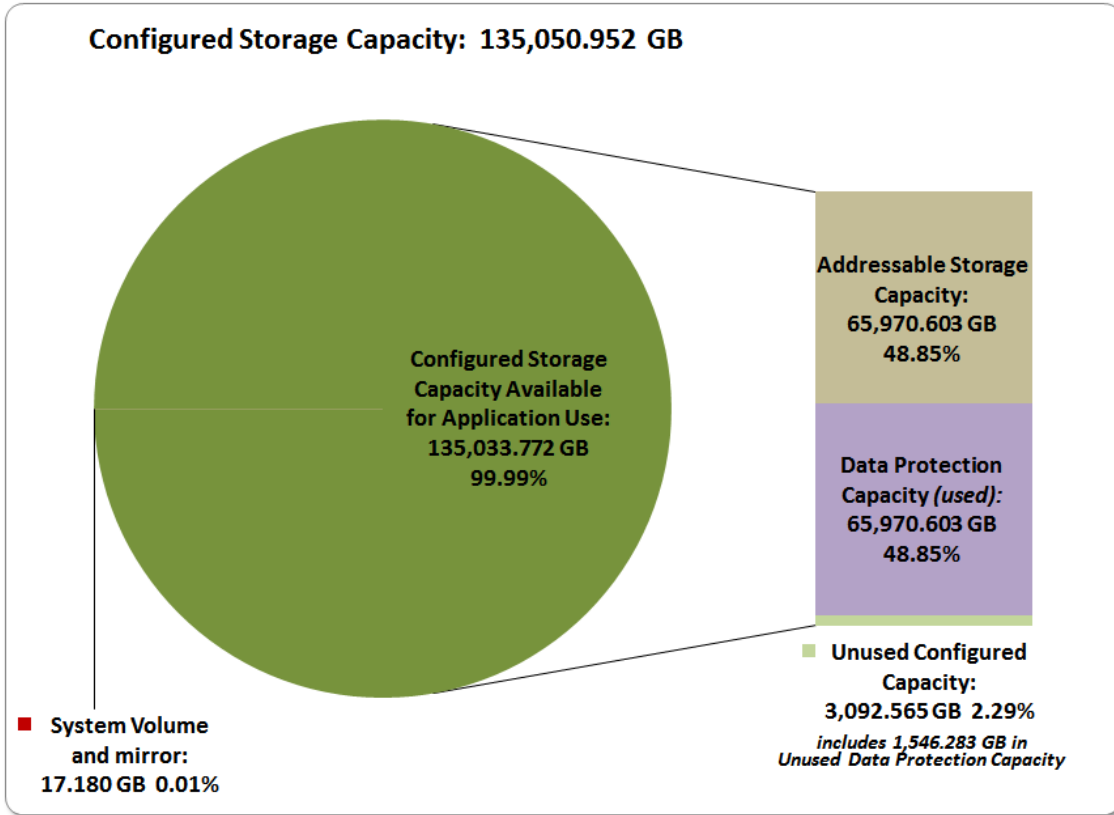

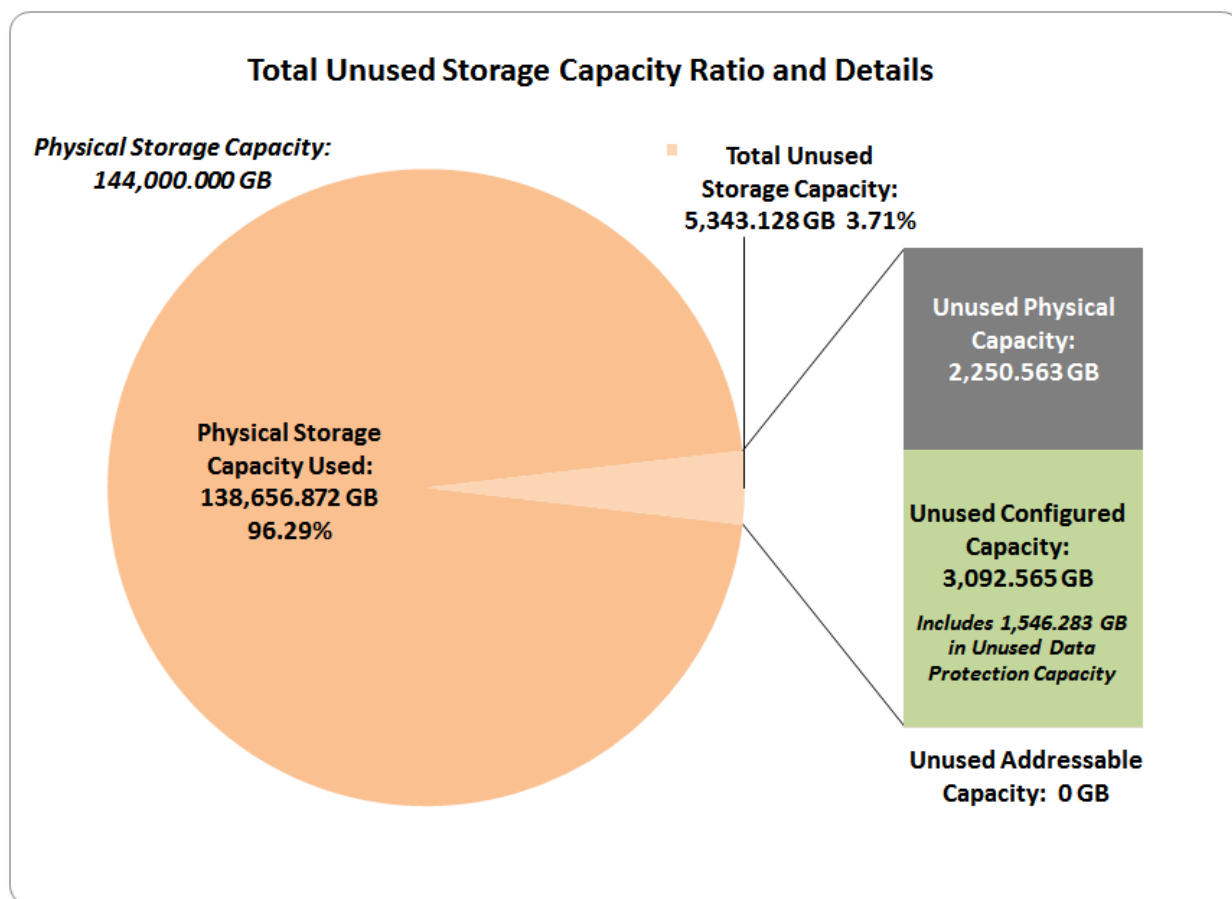

SPC-1 Storage Capacity Utilization	
Application Utilization	45.81%
Protected Application Utilization	91.63%
Unused Storage Ratio	3.71%

**Application Utilization:** Total ASU Capacity (65,970.603 GB) divided by Physical Storage Capacity (144,000.000 GB).

**Protected Application Utilization:** (Total ASU Capacity (65,970.603 GB) plus total Data Protection Capacity (67,516.886 GB) minus unused Data Protection Capacity (1,546.283 GB)) divided by Physical Storage Capacity (144,000.000 GB).

**Unused Storage Ratio:** Total Unused Capacity (5,343.128 GB) divided by Physical Storage Capacity (144,000.000 GB) and may not exceed 45%.

Detailed information for the various storage capacities and utilizations is available on pages 26-27.

## Response Time – Throughput Curve

The Response Time-Throughput Curve illustrates the Average Response Time (milliseconds) and I/O Request Throughput at 100%, 95%, 90%, 80%, 50%, and 10% of the workload level used to generate the SPC-1 IOPS™ metric.

The Average Response Time measured at any of the above load points cannot exceed 30 milliseconds or the benchmark measurement is invalid.

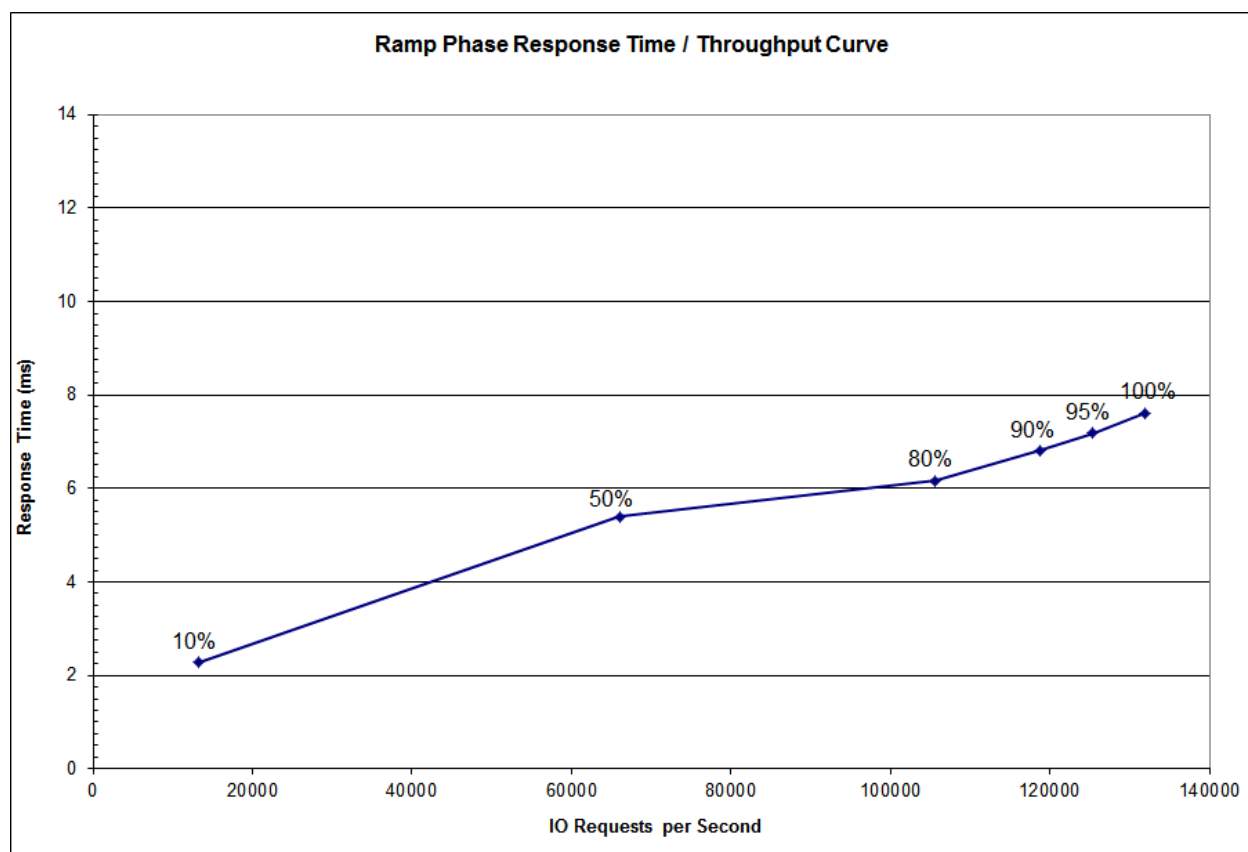

## Response Time – Throughput Data

	10% Load	50% Load	80% Load	90% Load	95% Load	100% Load
<b>I/O Request Throughput</b>	13,199.74	66,007.92	105,619.86	118,804.45	125,395.53	131,986.51
<b>Average Response Time (ms):</b>						
<b>All ASUs</b>	2.28	5.40	6.17	6.82	7.19	7.62
<b>ASU-1</b>	2.72	6.53	8.29	9.15	9.61	10.16
<b>ASU-2</b>	2.20	6.16	8.03	9.11	9.70	10.37
<b>ASU-3</b>	1.37	2.67	0.85	0.86	0.94	1.03
<b>Reads</b>	4.41	11.13	14.20	15.69	16.41	17.28
<b>Writes</b>	0.89	1.67	0.94	1.04	1.18	1.33



## Priced Storage Configuration Pricing

SKU	Description	Quantity	Unit List Price	Extended List	Discount	Extended Discount
<b>Hardware</b>						
NF5322-SFP16E	2 - 16Gb FC SFPs	4	\$367.00	\$1,468.00	20%	\$1,174.40
NF5332-SR01E	M310 2.5 inch Dual Controller Disk Array Unit w Base SW, 4 Port SAS Disk ports (w/o Host Port Card, SFP or Cache Memory)	1	\$16,788.00	\$16,788.00	20%	\$13,430.40
NF5322-SF06E	M110/M310 4 port FC Host Port Card w/o SFP	2	\$1,665.00	\$3,330.00	20%	\$2,664.00
Q24-HL000000072705	Localization Kit for M110/M310 Disk Array Unit	1	\$0.00	\$0.00	20%	\$0.00
NF5332-SC02SE	M310 Cache Memory 24GB for one Controller	2	\$987.00	\$1,974.00	20%	\$1,579.20
NF5322-SMA75E	SAS Disk Drive (2.5" 15krpm/300GB)	480	\$489.00	\$234,720.00	20%	\$187,776.00
NF5322-SE81E	Disk Enclosure 2.5 inch for Mx10	19	\$5,427.00	\$103,113.00	20%	\$82,490.40
Q24-HL000000072706	Localization Kit for Mx10 Disk Enclosure	19	\$0.00	\$0.00	20%	\$0.00
NF9100-SF22E	Front Bezel (2U Black, w/ NEC Logo) for Mx10	20	\$90.00	\$1,800.00	20%	\$1,440.00
N8190-158	NEC N8190-158 dual-port 16G FC HBAs (w/ SFP)	4	\$1,570.00	\$6,280.00	20%	\$5,024.00
<b>Software</b>						
Q24-HL000000074242	M310 60 Day Trial License Bundle	1	\$0.00	\$0.00	20%	\$0.00
Q24-HL000000072865	M310 Base Software	1	\$0.00	\$0.00	20%	\$0.00
<b>Maintenance</b>						
Q24-DN000000072488	3 Years Upgrade to Platinum M310 2.5 inch Dual Controller w/Base SW	1	\$3,132.00	\$3,132.00	15%	\$2,662.20
Q24-DN000000072623	3 Years Upgrade to Platinum M110/310 4 port FC Host Port Card w/ SFP	2	\$583.00	\$1,166.00	15%	\$991.10
Q24-DN000000072523	3 Years Upgrade to Platinum M310 Cache Memory 24GB for one Controller	2	\$346.00	\$692.00	15%	\$588.20
Q24-DN000000072609	3 Years Upgrade to Platinum Disk Enclosure 2.5 inch for Mx10	19	\$1,900.00	\$36,100.00	15%	\$30,685.00
Q24-DN000000072915	1 Year Upgrade to Platinum SW Maintenance M310 Base Software	3	\$941.00	\$2,823.00	15%	\$2,399.55
<b>Cables and Racks</b>						
Power Strips	Power Strips (8 outlets)	6	\$78.00	\$468.00	10%	\$421.20
RACK	Rack 42U	1	\$1,799.00	\$1,799.00	10%	\$1,619.10
FC CABLE	CRU FC CABLE 5M x2 (M#LCLC-5MQ) 5M	4	\$54.00	\$216.00	10%	\$194.40
<b>Configuration Total</b>				<b>\$415,869.00</b>		<b>\$335,139.15</b>

- *Power codes for M310 and Disk Enclosures are included in Localization Kits (Q24-HL000000072705 and Q24-HL000000072706).*
- *Price of M310 Disk Array Unit includes price of M310 Base Software (Q24-HL000000072865).*
- *PathManager for Windows/Linux/VMware is included in M310 Base Software (Q24-HL000000072865).*

The above pricing includes hardware maintenance and software support for three years, 7 days per week, 24 hours per day. The hardware maintenance and software support provides the following:

- Acknowledgement of new and existing problems within four (4) hours.
- Onsite presence of a qualified maintenance engineer or provision of a customer replaceable part within four (4) hours of the above acknowledgement for any hardware failure that results in an inoperative Price Storage Configuration that can be remedied by the repair or replacement of a Priced Storage Configuration component.

### **Differences between the Tested Storage Configuration (TSC) and Priced Storage Configuration**

There were no differences between the Tested Storage Configuration and the Priced Storage Configuration.

### Priced Storage Configuration Diagram

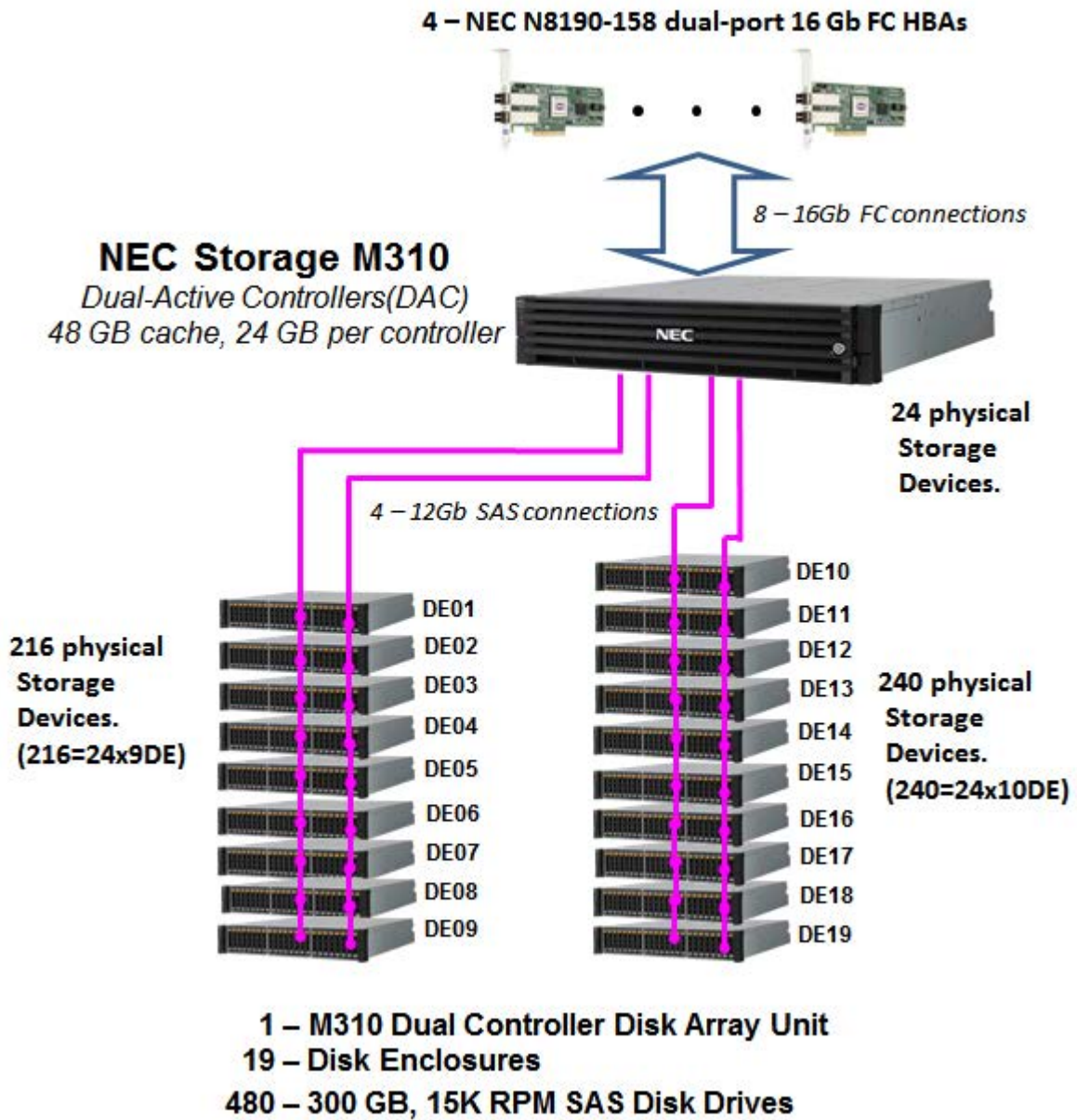

### Priced Storage Configuration Components

<b>Priced Storage Configuration</b>
4 – NEC N8190-158 dual-port 16Gb FC HBAs
<b>NEC Storage M310</b> Dual-Active Controllers, each with 24 GB memory ( <i>48 GB total</i> ) 2 – 12 Gb SAS ports ( <i>4 ports total</i> )
2 – 4-port FC Host Port Cards <i>(2 cards and 4 ports per controller, 8 ports total and used)</i>
19 – Disk Enclosures, 2.5"
480 – 300 GB, 15K RPM SAS disk drives (HDDs) (24 HDDs in each of the 19 disk enclosures 24 HDDs in the M310 Dual Controller Disk Array Unit)
1 – 42U Rack with 6 power strips ( <i>8 outlets per strip</i> )

In each of the following sections of this document, the appropriate Full Disclosure Report requirement, from the SPC-1 benchmark specification, is stated in italics followed by the information to fulfill the stated requirement.

## **CONFIGURATION INFORMATION**

### **Benchmark Configuration (BC)/Tested Storage Configuration (TSC) Diagram**

#### **Clause 9.4.3.4.1**

*A one page Benchmark Configuration (BC)/Tested Storage Configuration (TSC) diagram shall be included in the FDR...*

The Benchmark Configuration (BC)/Tested Storage Configuration (TSC) is illustrated on page [22 \(Benchmark Configuration/Tested Storage Configuration Diagram\)](#).

### **Storage Network Configuration**

#### **Clause 9.4.3.4.1**

...

5. *If the TSC contains network storage, the diagram will include the network configuration. If a single diagram is not sufficient to illustrate both the Benchmark Configuration and network configuration in sufficient detail, the Benchmark Configuration diagram will include a high-level network illustration as shown in Figure 9-8. In that case, a separate, detailed network configuration diagram will also be included as described in Clause 9.4.3.4.2.*

#### **Clause 9.4.3.4.2**

*If a storage network was configured as a part of the Tested Storage Configuration and the Benchmark Configuration diagram described in Clause 9.4.3.4.1 contains a high-level illustration of the network configuration, the Executive Summary will contain a one page topology diagram of the storage network as illustrated in Figure 9-9.*

The Tested Storage Configuration (TSC) was configured with direct-attached storage.

### **Host System(s) and Tested Storage Configuration (TSC) Table of Components**

#### **Clause 9.4.3.4.3**

*The FDR will contain a table that lists the major components of each Host System and the Tested Storage Configuration (TSC).*

The Host System(s) and TSC table of components may be found on page [23 \(Host System and Tested Storage Configuration Components\)](#).

### Benchmark Configuration/Tested Storage Configuration Diagram

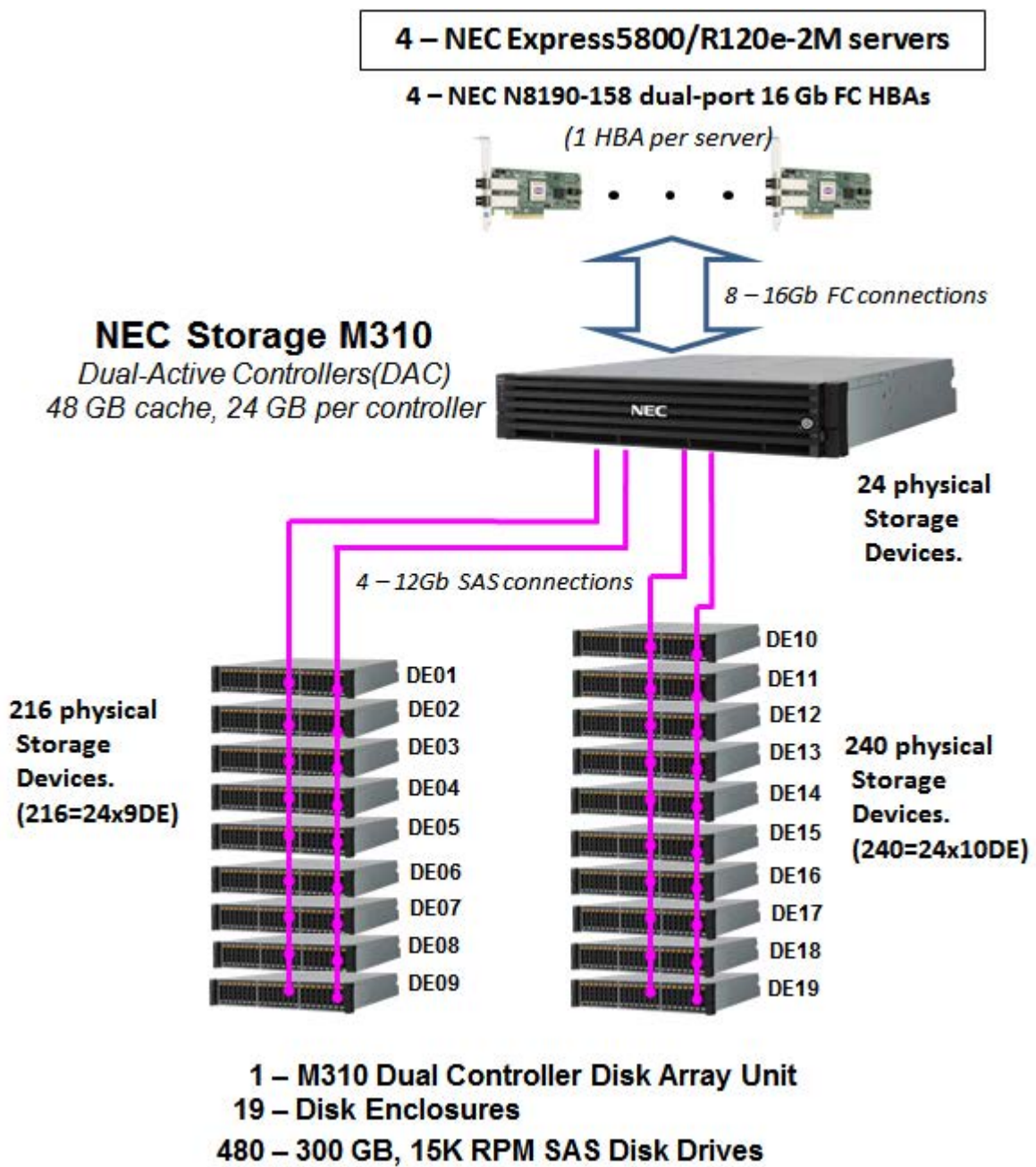

**Host System and Tested Storage Configuration Components**

<b>Host Systems</b>
<p><b>4 – NEC Express5800/R120e-2M servers</b>, each with:</p> <ul style="list-style-type: none"> <li>2 – Intel® Xeon® 2.6 GHz E5-2630 v2 processors 6 cores per processor and 15 MB Intel® Smart Cache</li> <li>16 GB main memory</li> <li>Windows Server 2008 R2 Standard with SP1</li> <li>PCIe</li> </ul>
<b>Tested Storage Configuration (TSC) Components</b>
<p>4 – NEC N8190-158 dual-port 16Gb FC HBAs</p>
<p><b>NEC Storage M310</b></p> <p>Dual-Active Controllers, each with</p> <ul style="list-style-type: none"> <li>24 GB memory (<i>48 GB total</i>)</li> <li>2 – 12 Gb SAS ports (<i>4 ports total</i>)</li> </ul>
<p>2 – 4-port FC Host Port Cards <i>(2 cards and 4 ports per controller, 8 ports total and used)</i></p>
<p>19 – Disk Enclosures, 2.5”</p>
<p>480 – 300 GB, 15K RPM SAS disk drives (HDDs) (24 HDDs in each of the 19 disk enclosures 24 HDDs in the M310 Dual Controller Disk Array Unit)</p>
<p>1 – 42U Rack with 6 power strips (<i>8 outlets per strip</i>)</p>



## Customer Tunable Parameters and Options

### Clause 9.4.3.5.1

All Benchmark Configuration (BC) components with customer tunable parameter and options that have been altered from their default values must be listed in the FDR. The FDR entry for each of those components must include both the name of the component and the altered value of the parameter or option. If the parameter name is not self-explanatory to a knowledgeable practitioner, a brief description of the parameter's use must also be included in the FDR entry.

[Appendix B: Customer Tunable Parameters and Options](#) on page 67 contains the customer tunable parameters and options that have been altered from their default values for this benchmark.

## Tested Storage Configuration (TSC) Description

### Clause 9.4.3.5.2

The FDR must include sufficient information to recreate the logical representation of the TSC. In addition to customer tunable parameters and options (Clause 4.2.4.5.3), that information must include, at a minimum:

- A diagram and/or description of the following:
  - All physical components that comprise the TSC. Those components are also illustrated in the BC Configuration Diagram in Clause 9.2.4.4.1 and/or the Storage Network Configuration Diagram in Clause 9.2.4.4.2.
  - The logical representation of the TSC, configured from the above components that will be presented to the Workload Generator.
- Listings of scripts used to create the logical representation of the TSC.
- If scripts were not used, a description of the process used with sufficient detail to recreate the logical representation of the TSC.

[Appendix C: Tested Storage Configuration \(TSC\) Creation](#) on page 68 contains the detailed information that describes how to create and configure the logical TSC.

## SPC-1 Workload Generator Storage Configuration

### Clause 9.4.3.5.3

The FDR must include all SPC-1 Workload Generator storage configuration commands and parameters.

The SPC-1 Workload Generator storage configuration commands and parameters for this measurement appear in [Appendix D: SPC-1 Workload Generator Storage Commands and Parameters](#) on page 72.



## ASU Pre-Fill

### Clause 5.3.3

*Each of the three SPC-1 ASUs (ASU-1, ASU-2 and ASU-3) is required to be completely filled with specified content prior to the execution of audited SPC-1 Tests. The content is required to consist of random data pattern such as that produced by an SPC recommended tool.*

The configuration file used to complete the required ASU pre-fill appears in [Appendix D: SPC-1 Workload Generator Storage Commands and Parameters](#) on page [72](#).

## **SPC-1 DATA REPOSITORY**

This portion of the Full Disclosure Report presents the detailed information that fully documents the various SPC-1 storage capacities and mappings used in the Tested Storage Configuration. [SPC-1 Data Repository Definitions](#) on page [63](#) contains definitions of terms specific to the SPC-1 Data Repository.

### **Storage Capacities and Relationships**

#### **Clause 9.4.3.6.1**

*Two tables and four charts documenting the storage capacities and relationships of the SPC-1 Storage Hierarchy (Clause 2.1) shall be included in the FDR. ... The capacity value in each chart may be listed as an integer value, for readability, rather than the decimal value listed in the table below.*

#### **SPC-1 Storage Capacities**

The Physical Storage Capacity consisted of 144,000.000 GB distributed over 480 disk drives (HDDs) each with a formatted capacity of 300.000 GB. There was 2,250.563 GB (1.56%) of Unused Storage within the Physical Storage Capacity. Global Storage Overhead consisted of 6,698.485 GB (4.65%) of the Physical Storage Capacity. There was 3,092.565 GB (2.29%) of Unused Storage within the Configured Storage Capacity. The Total ASU Capacity utilized 100% of the Addressable Storage Capacity resulting in 0.00 GB (0.00%) of Unused Storage within the Addressable Storage Capacity. The Data Protection (*Mirroring*) capacity was 67,516.886 GB of which 65,970.603 GB was utilized. The total Unused Storage capacity was 5,343.128 GB.

*Note: The configured Storage Devices may include additional storage capacity reserved for system overhead, which is not accessible for application use. That storage capacity may not be included in the value presented for Physical Storage Capacity.*

<b>SPC-1 Storage Capacities</b>		
<b>Storage Hierarchy Component</b>	<b>Units</b>	<b>Capacity</b>
Total ASU Capacity	Gigabytes (GB)	65,970.603
Addressable Storage Capacity	Gigabytes (GB)	65,970.603
Configured Storage Capacity	Gigabytes (GB)	135,050.952
Physical Storage Capacity	Gigabytes (GB)	144,000.000
Data Protection ( <i>Mirroring</i> )	Gigabytes (GB)	67,516.886
Required Storage ( <i>system overhead/metadata</i> )	Gigabytes (GB)	17.180
Global Storage Overhead	Gigabytes (GB)	6,698.485
Total Unused Storage	Gigabytes (GB)	5,343.128

SPC-1 Storage Hierarchy Ratios

	Addressable Storage Capacity	Configured Storage Capacity	Physical Storage Capacity
Total ASU Capacity	100.00%	48.85%	45.81%
Required for Data Protection ( <i>Mirroring</i> )		49.99%	46.89%
Addressable Storage Capacity		48.85%	45.81%
Required Storage ( <i>system overhead/metadata</i> )		0.01%	0.01%
Configured Storage Capacity			93.79%
Global Storage Overhead			4.65%
Unused Storage:			
Addressable	0.00%		
Configured		2.29%	
Physical			1.56%

SPC-1 Storage Capacity Charts

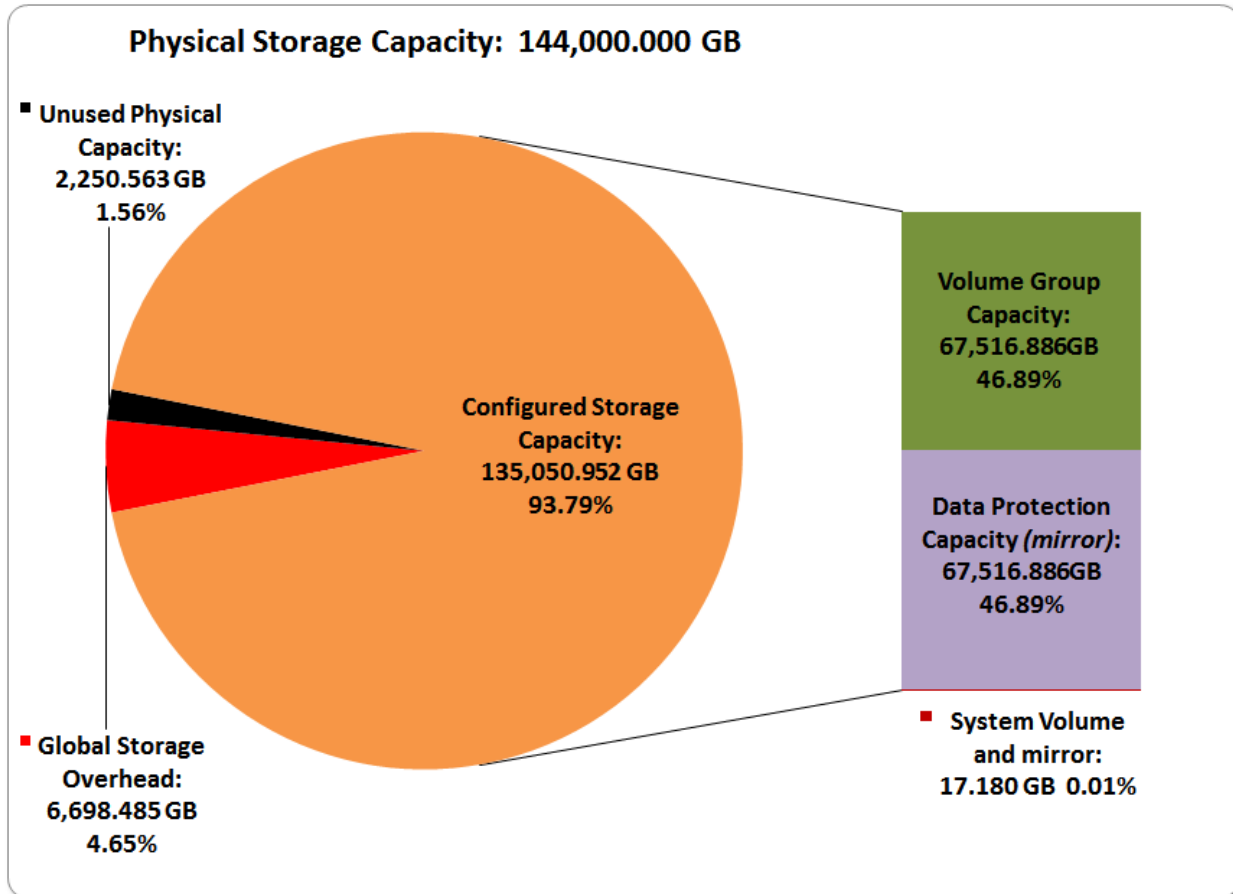

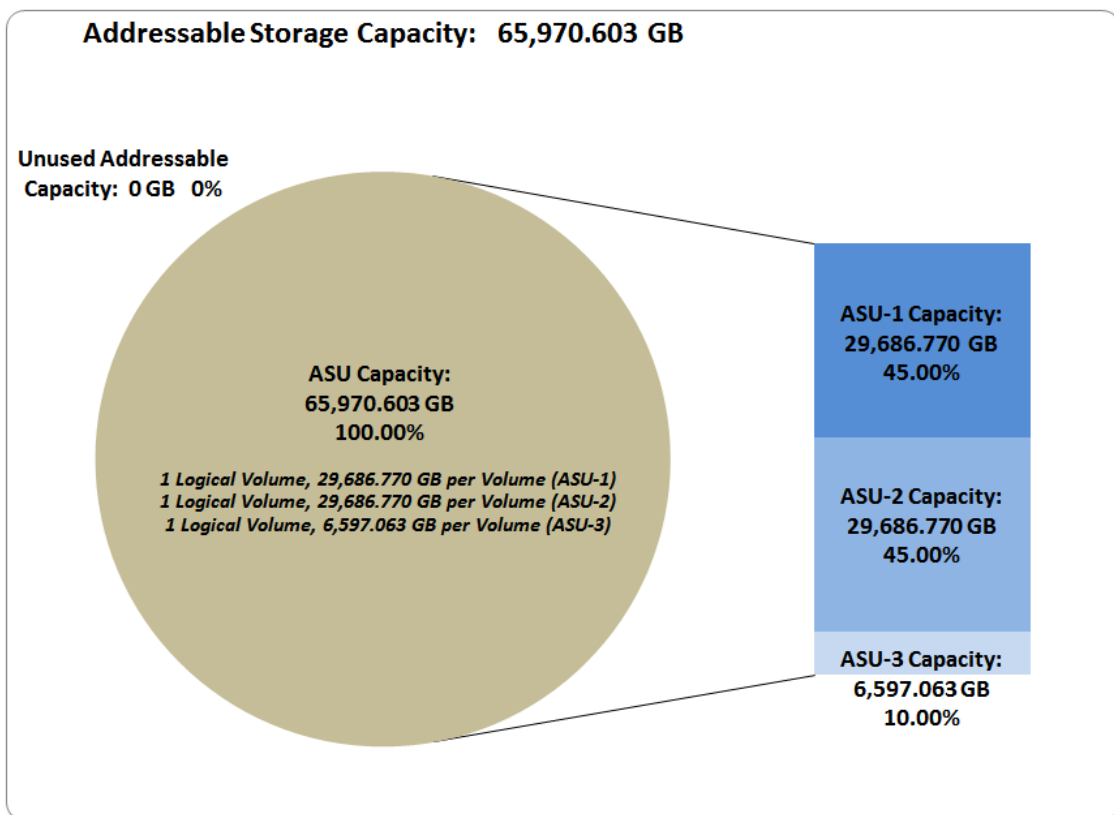
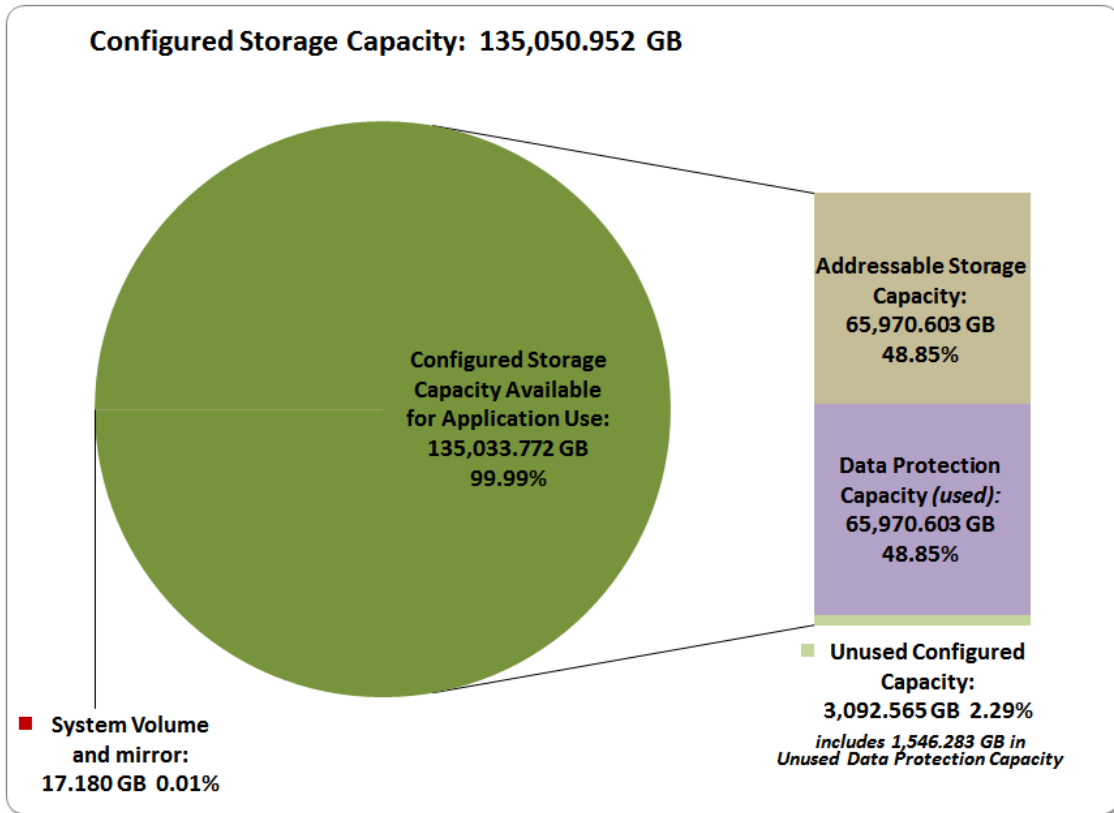

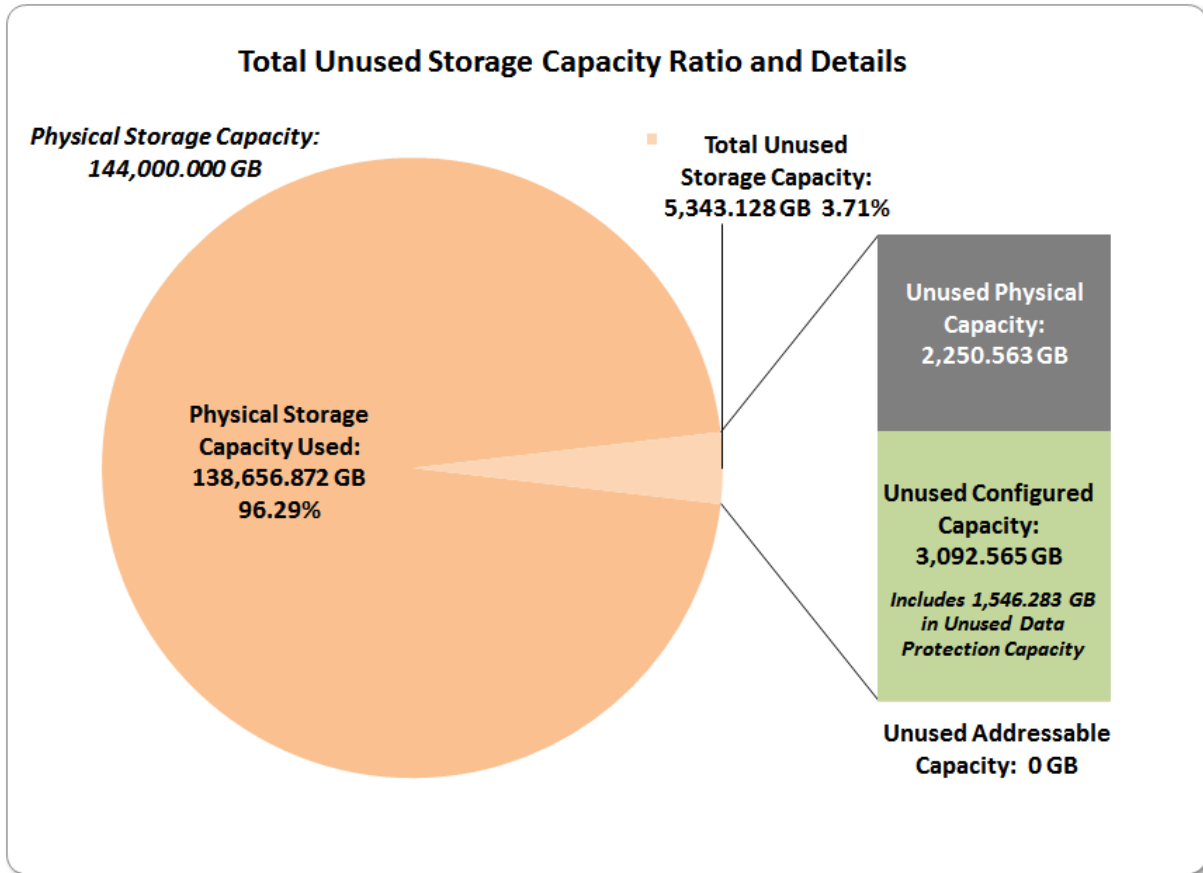

## Storage Capacity Utilization

### Clause 9.4.3.6.2

The FDR will include a table illustrating the storage capacity utilization values defined for Application Utilization (Clause 2.8.1), Protected Application Utilization (Clause 2.8.2), and Unused Storage Ratio (Clause 2.8.3).

### Clause 2.8.1

Application Utilization is defined as Total ASU Capacity divided by Physical Storage Capacity.

### Clause 2.8.2

Protected Application Utilization is defined as (Total ASU Capacity plus total Data Protection Capacity minus unused Data Protection Capacity) divided by Physical Storage Capacity.

### Clause 2.8.3

Unused Storage Ratio is defined as Total Unused Capacity divided by Physical Storage Capacity and may not exceed 45%.

SPC-1 Storage Capacity Utilization	
Application Utilization	45.81%
Protected Application Utilization	91.63%
Unused Storage Ratio	3.71%

### Logical Volume Capacity and ASU Mapping

Clause 9.4.3.6.3

A table illustrating the capacity of each ASU and the mapping of Logical Volumes to ASUs shall be provided in the FDR. ... Logical Volumes shall be sequenced in the table from top to bottom per its position in the contiguous address space of each ASU. The capacity of each Logical Volume shall be stated. ... In conjunction with this table, the Test Sponsor shall provide a complete description of the type of data protection (see Clause 2.4.5) used on each Logical Volume.

Logical Volume Capacity and Mapping
<b>ASU-1 (GB)</b>
1 Logical Volume 29,686.770 GB per Logical Volume (29,686.770 GB used per Logical Volume)
<b>ASU-2 (GB)</b>
1 Logical Volume 29,686.770 GB per Logical Volume (29,686.770 GB used per Logical Volume)
<b>ASU-3 (GB)</b>
1 Logical Volume 6,597.063 GB per Logical Volume (6,597.063 GB used per Logical Volume)

The Data Protection Level used for all Logical Volumes was [Protected 2](#) using *Mirroring* as described on page [12](#). See “ASU Configuration” in the [IOPS Test Results File](#) for more detailed configuration information.

## **SPC-1 BENCHMARK EXECUTION RESULTS**

This portion of the Full Disclosure Report documents the results of the various SPC-1 Tests, Test Phases, and Test Runs. An [SPC-1 glossary](#) on page 63 contains definitions of terms specific to the SPC-1 Tests, Test Phases, and Test Runs.

### *Clause 5.4.3*

*The Tests must be executed in the following sequence: Primary Metrics, Repeatability, and Data Persistence. That required sequence must be uninterrupted from the start of Primary Metrics to the completion of Persistence Test Run 1. Uninterrupted means the Benchmark Configuration shall not be power cycled, restarted, disturbed, altered, or adjusted during the above measurement sequence. If the required sequence is interrupted other than for the Host System/TSC power cycle between the two Persistence Test Runs, the measurement is invalid.*

## **SPC-1 Tests, Test Phases, and Test Runs**

The SPC-1 benchmark consists of the following Tests, Test Phases, and Test Runs:

- **Primary Metrics Test**
  - Sustainability Test Phase and Test Run
  - IOPS Test Phase and Test Run
  - Response Time Ramp Test Phase
    - 95% of IOPS Test Run
    - 90% of IOPS Test Run
    - 80% of IOPS Test Run
    - 50% of IOPS Test Run
    - 10% of IOPS Test Run (LRT)
- **Repeatability Test**
  - Repeatability Test Phase 1
    - 10% of IOPS Test Run (LRT)
    - IOPS Test Run
  - Repeatability Test Phase 2
    - 10% of IOPS Test Run (LRT)
    - IOPS Test Run
- **Data Persistence Test**
  - Data Persistence Test Run 1
  - Data Persistence Test Run 2

Each Test is an atomic unit that must be executed from start to finish before any other Test, Test Phase, or Test Run may be executed.

The results from each Test, Test Phase, and Test Run are listed below along with a more detailed explanation of each component.

## **“Ramp-Up” Test Runs**

### Clause 5.3.13

*In order to warm-up caches or perform the initial ASU data migration in a multi-tier configuration, a Test Sponsor may perform a series of “Ramp-Up” Test Runs as a substitute for an initial, gradual Ramp-Up.*

### Clause 5.3.13.3

*The “Ramp-Up” Test Runs will immediately precede the Primary Metrics Test as part of the uninterrupted SPC-1 measurement sequence.*

### Clause 9.4.3.7.1

*If a series of “Ramp-Up” Test Runs were included in the SPC-1 measurement sequence, the FDR shall report the duration (ramp-up and measurement interval), BSU level, SPC-1 IOPS and average response time for each “Ramp-Up” Test Run in an appropriate table.*

There were no “Ramp-Up” Test Runs executed.

## **Primary Metrics Test – Sustainability Test Phase**

### Clause 5.4.4.1.1

*The Sustainability Test Phase has exactly one Test Run and shall demonstrate the maximum sustainable I/O Request Throughput within at least a continuous eight (8) hour Measurement Interval. This Test Phase also serves to insure that the TSC has reached Steady State prior to reporting the final maximum I/O Request Throughput result (SPC-1 IOPS™).*

### Clause 5.4.4.1.2

*The computed I/O Request Throughput of the Sustainability Test must be within 5% of the reported SPC-1 IOPS™ result.*

### Clause 5.4.4.1.4

*The Average Response Time, as defined in Clause 5.1.1, will be computed and reported for the Sustainability Test Run and cannot exceed 30 milliseconds. If the Average Response time exceeds that 30-milliseconds constraint, the measurement is invalid.*

### Clause 9.4.3.7.2

*For the Sustainability Test Phase the FDR shall contain:*

- 1. A Data Rate Distribution graph and data table.*
- 2. I/O Request Throughput Distribution graph and data table.*
- 3. A Response Time Frequency Distribution graph and table.*
- 4. An Average Response Time Distribution graph and table.*
- 5. The human readable Test Run Results File produced by the Workload Generator (may be included in an appendix).*
- 6. A listing or screen image of all input parameters supplied to the Workload Generator (may be included in an appendix).*
- 7. The Measured Intensity Multiplier for each I/O stream.*
- 8. The variability of the Measured Intensity Multiplier, as defined in Clause 5.3.13.3.*



### SPC-1 Workload Generator Input Parameters

The SPC-1 Workload Generator input parameters for the Sustainability, IOPS, Response Time Ramp, Repeatability, and Persistence Test Runs are documented in [Appendix E: SPC-1 Workload Generator Input Parameters](#) on Page 73.

### Sustainability Test Results File

A link to the test results file generated from the Sustainability Test Run is listed below.

[Sustainability Test Results File](#)

### Sustainability – Data Rate Distribution Data (MB/second)

The Sustainability Data Rate table of data is not embedded in this document due to its size. The table is available via the following URL:

[Sustainability Data Rate Table](#)

### Sustainability – Data Rate Distribution Graph

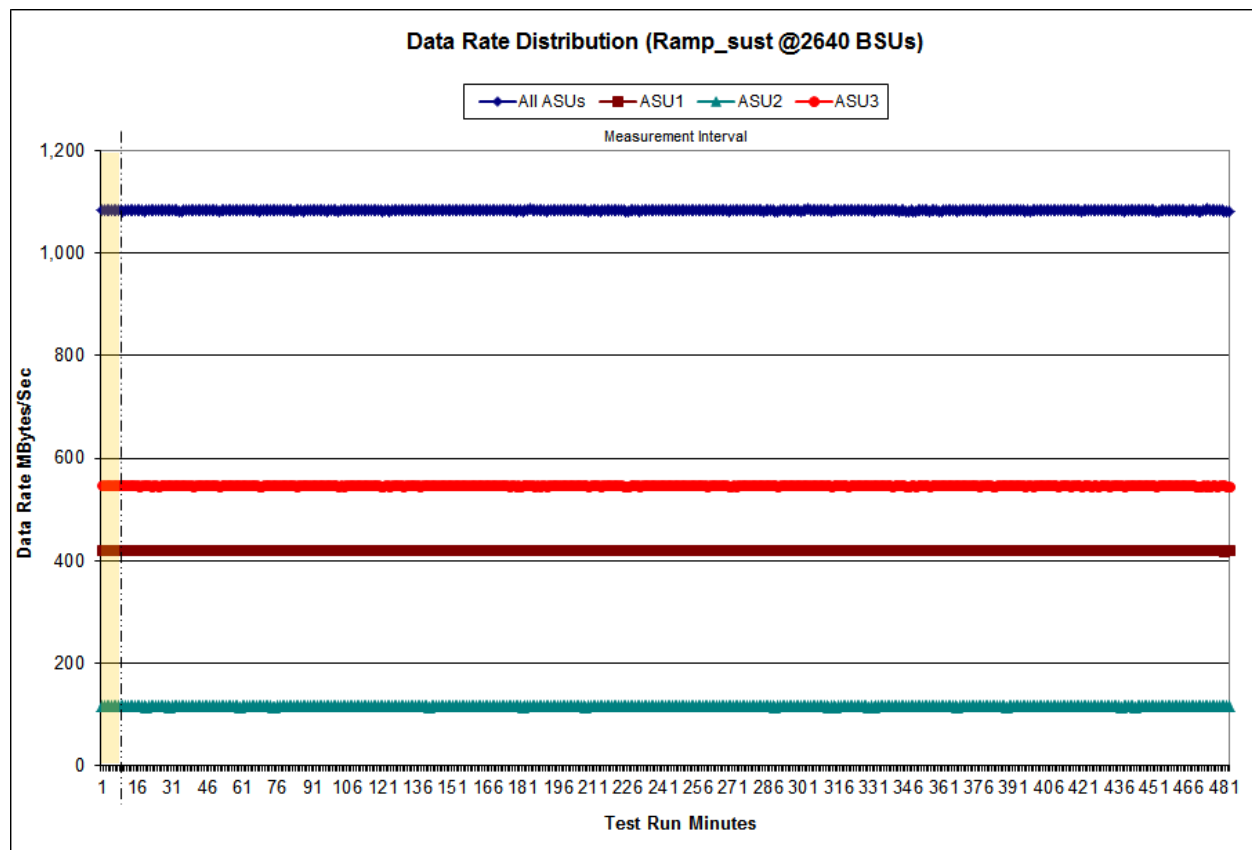

### Sustainability – I/O Request Throughput Distribution Data

The Sustainability I/O Request Throughput table of data is not embedded in this document due to its size. The table is available via the following URL:

[Sustainability I/O Request Throughput Table](#)

### Sustainability – I/O Request Throughput Distribution Graph

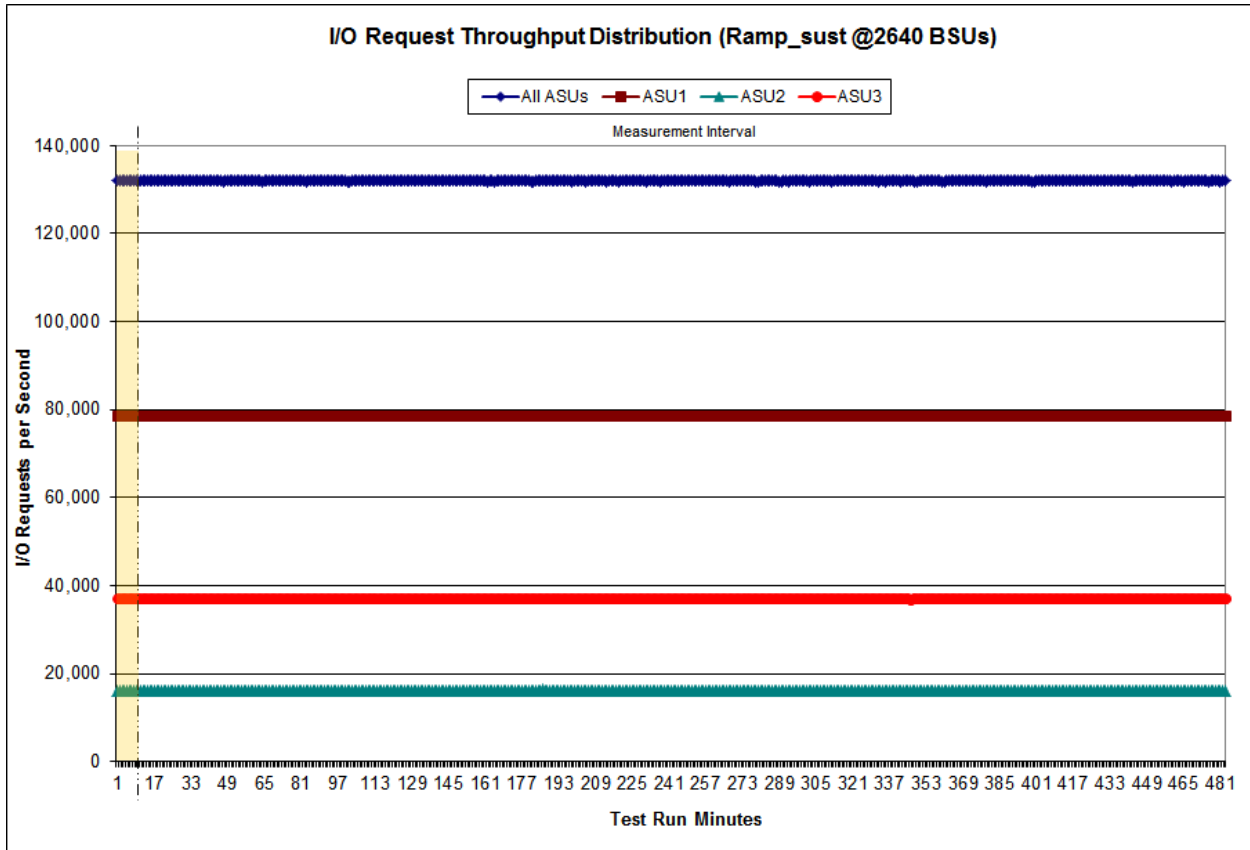

### Sustainability – Average Response Time (ms) Distribution Data

The Sustainability Average Response Time table of data is not embedded in this document due to its size. The table is available via the following URL:

[Sustainability Average Response Time Table](#)

### Sustainability – Average Response Time (ms) Distribution Graph

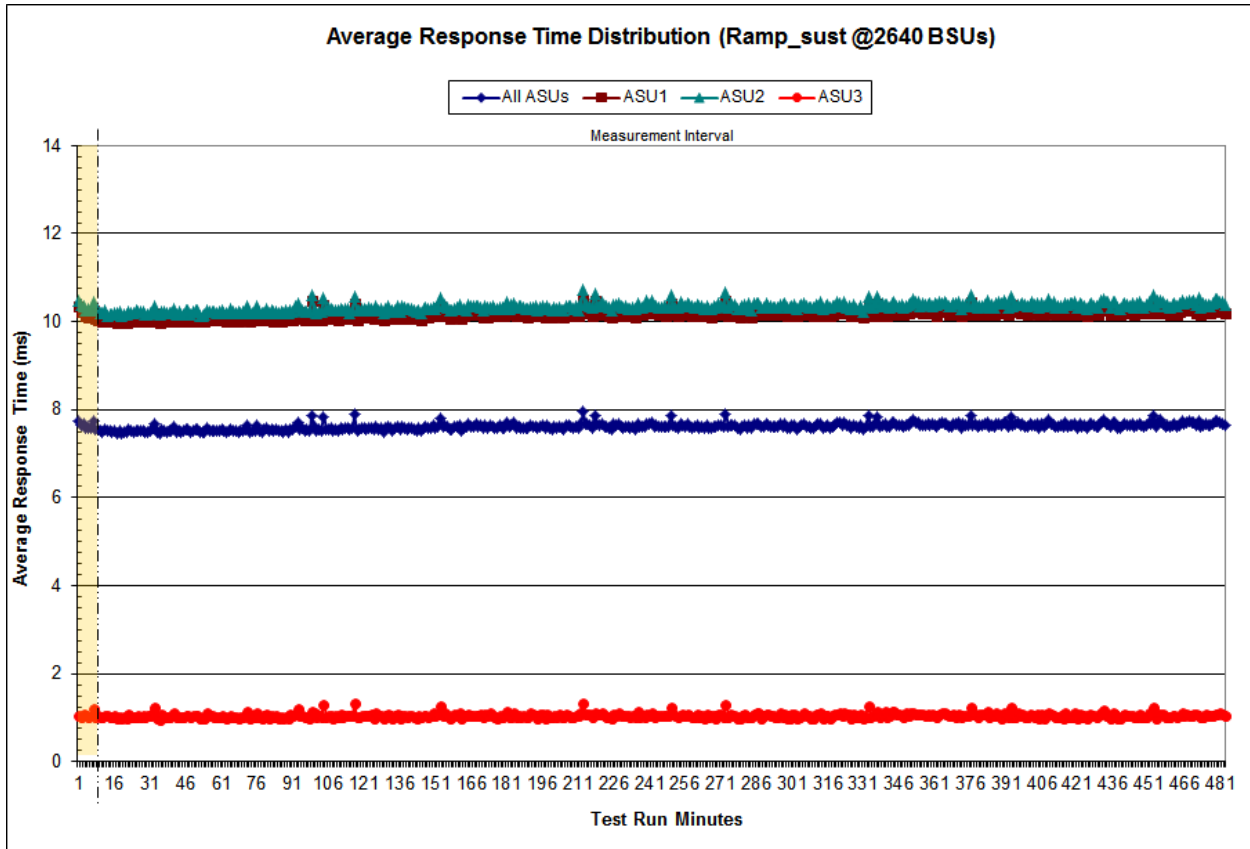

**Sustainability – Response Time Frequency Distribution Data**

Response Time (ms)	0-0.25	>0.25-0.5	>0.5-0.75	>0.75-1.0	>1.0-1.25	>1.25-1.5	>1.5-1.75	>1.75-2.0
Read	12,658,417	46,559,233	59,887,828	13,542,983	5,275,330	5,240,982	6,642,128	8,112,383
Write	33,163	734,098,148	1,196,719,835	237,343,660	55,932,930	15,404,523	4,848,378	1,535,454
All ASUs	12,691,580	780,657,381	1,256,607,663	250,886,643	61,208,260	20,645,505	11,490,506	9,647,837
ASU1	11,801,865	356,826,790	508,225,540	124,955,745	45,722,522	16,506,448	9,579,483	8,380,156
ASU2	877,639	91,785,195	131,934,921	27,692,610	8,858,480	3,289,926	1,637,962	1,116,808
ASU3	12,076	332,045,396	616,447,202	98,238,288	6,627,258	849,131	273,061	150,873
Response Time (ms)	>2.0-2.5	>2.5-3.0	>3.0-3.5	>3.5-4.0	>4.0-4.5	>4.5-5.0	>5.0-6.0	>6.0-7.0
Read	19,028,233	27,550,305	30,265,668	40,330,846	45,636,149	55,248,268	101,154,869	85,605,239
Write	882,875	714,253	657,021	789,544	762,596	1,024,480	2,067,565	2,030,961
All ASUs	19,911,108	28,264,558	30,922,689	41,120,390	46,398,745	56,272,748	103,222,434	87,636,200
ASU1	17,538,940	24,931,834	27,174,871	36,126,622	40,790,176	49,332,743	89,756,961	75,748,706
ASU2	2,175,349	3,157,393	3,583,558	4,815,146	5,434,361	6,742,656	13,061,090	11,485,068
ASU3	196,819	175,331	164,260	178,622	174,208	197,349	404,383	402,426
Response Time (ms)	>7.0-8.0	>8.0-9.0	>9.0-10.0	>10.0-15.0	>15.0-20.0	>20.0-25.0	>25.0-30.0	>30.0
Read	74,718,365	57,965,162	52,107,844	191,755,006	130,064,546	95,758,675	73,373,139	260,885,382
Write	2,034,304	1,956,092	1,834,312	7,339,062	5,510,770	4,408,011	3,636,536	20,652,937
All ASUs	76,752,669	59,921,254	53,942,156	199,094,068	135,575,316	100,166,686	77,009,675	281,538,319
ASU1	66,316,195	51,497,543	46,429,771	170,557,282	115,366,881	84,468,552	64,247,901	223,455,577
ASU2	10,061,339	8,072,668	7,186,678	27,118,086	19,019,316	14,673,948	11,872,086	51,919,951
ASU3	375,135	351,043	325,707	1,418,700	1,189,119	1,024,186	889,688	6,162,791

**Sustainability – Response Time Frequency Distribution Graph**

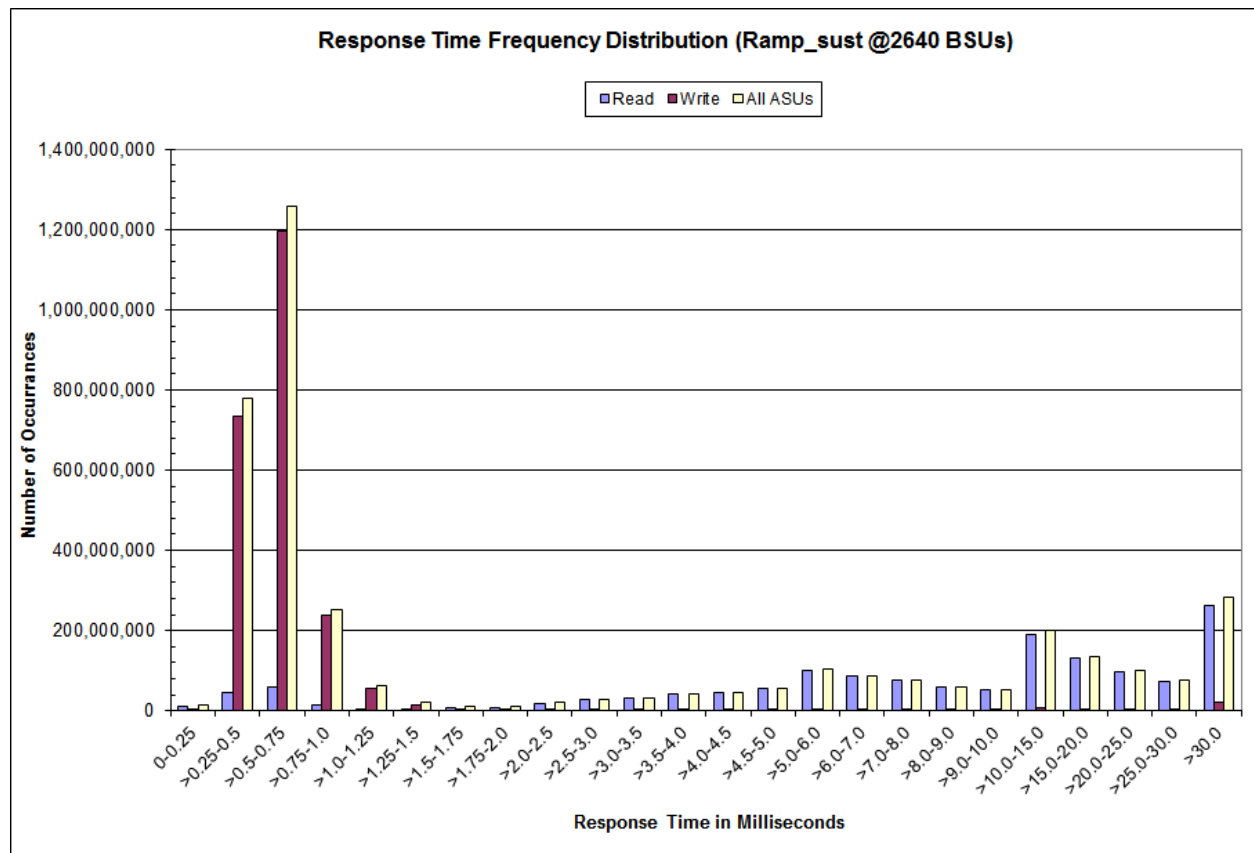

**Sustainability – Measured Intensity Multiplier and Coefficient of Variation**

Clause 3.4.3

**IM – Intensity Multiplier:** *The ratio of I/Os for each I/O stream relative to the total I/Os for all I/O streams (ASU1-1 – ASU3-1) as required by the benchmark specification.*

Clauses 5.1.10 and 5.3.15.2

**MIM – Measured Intensity Multiplier:** *The Measured Intensity Multiplier represents the ratio of measured I/Os for each I/O stream relative to the total I/Os measured for all I/O streams (ASU1-1 – ASU3-1). This value may differ from the corresponding Expected Intensity Multiplier by no more than 5%.*

Clause 5.3.15.3

**COV – Coefficient of Variation:** *This measure of variation for the Measured Intensity Multiplier cannot exceed 0.2.*

	ASU1-1	ASU1-2	ASU1-3	ASU1-4	ASU2-1	ASU2-2	ASU2-3	ASU3-1
<b>IM</b>	0.0350	0.2810	0.0700	0.2100	0.0180	0.0700	0.0350	0.2810
MIM	0.0350	0.2810	0.0700	0.2100	0.0180	0.0700	0.0350	0.2810
COV	0.002	0.001	0.001	0.001	0.003	0.001	0.002	0.001

## Primary Metrics Test – IOPS Test Phase

### Clause 5.4.4.2

*The IOPS Test Phase consists of one Test Run at the 100% load point with a Measurement Interval of ten (10) minutes. The IOPS Test Phase immediately follows the Sustainability Test Phase without any interruption or manual intervention.*

*The IOPS Test Run generates the SPC-1 IOPS™ primary metric, which is computed as the I/O Request Throughput for the Measurement Interval of the IOPS Test Run.*

*The Average Response Time is computed for the IOPS Test Run and cannot exceed 30 milliseconds. If the Average Response Time exceeds the 30 millisecond constraint, the measurement is invalid.*

### Clause 9.4.3.7.3

*For the IOPS Test Phase the FDR shall contain:*

- 1. I/O Request Throughput Distribution (data and graph).*
- 2. A Response Time Frequency Distribution.*
- 3. An Average Response Time Distribution.*
- 4. The human readable Test Run Results File produced by the Workload Generator.*
- 5. A listing or screen image of all input parameters supplied to the Workload Generator.*
- 6. The total number of I/O Requests completed in the Measurement Interval as well as the number of I/O Requests with a Response Time less than or equal to 30 milliseconds and the number of I/O Requests with a Response Time greater than 30 milliseconds.*

## SPC-1 Workload Generator Input Parameters

The SPC-1 Workload Generator input parameters for the Sustainability, IOPS, Response Time Ramp, Repeatability, and Persistence Test Runs are documented in [Appendix E: SPC-1 Workload Generator Input Parameters](#) on Page [73](#).

## IOPS Test Results File

A link to the test results file generated from the IOPS Test Run is listed below.

[IOPS Test Results File](#)

**IOPS Test Run – I/O Request Throughput Distribution Data**

2,640 BSUs	Start	Stop	Interval	Duration
<i>Start-Up/Ramp-Up</i>	19:55:23	19:58:24	0-2	0:03:01
<i>Measurement Interval</i>	19:58:24	20:08:24	3-12	0:10:00
60 second intervals	All ASUs	ASU1	ASU2	ASU3
0	132,085.83	78,703.23	16,257.60	37,125.00
1	131,995.55	78,691.20	16,237.92	37,066.43
2	131,903.55	78,623.03	16,210.02	37,070.50
3	132,004.05	78,663.20	16,254.35	37,086.50
4	131,994.63	78,679.23	16,228.45	37,086.95
5	132,023.20	78,699.92	16,267.32	37,055.97
6	131,970.58	78,635.85	16,223.42	37,111.32
7	131,936.48	78,634.62	16,241.40	37,060.47
8	132,043.07	78,645.18	16,250.73	37,147.15
9	131,907.67	78,632.07	16,214.50	37,061.10
10	131,935.12	78,608.92	16,242.17	37,084.03
11	132,012.02	78,705.07	16,222.47	37,084.48
12	132,038.23	78,669.65	16,236.45	37,132.13
<b>Average</b>	<b>131,986.51</b>	<b>78,657.37</b>	<b>16,238.13</b>	<b>37,091.01</b>

**IOPS Test Run – I/O Request Throughput Distribution Graph**

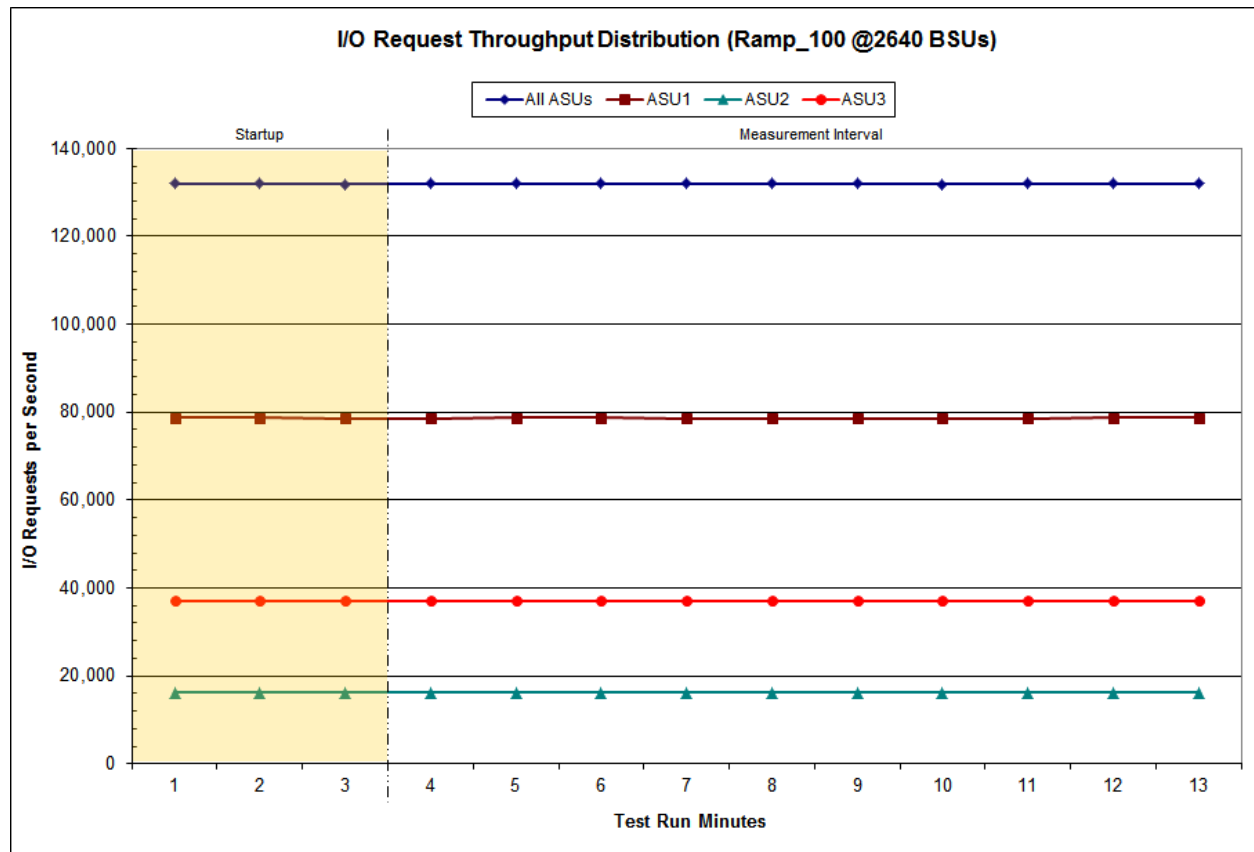

**IOPS Test Run – Average Response Time (ms) Distribution Data**

2,640 BSUs	Start	Stop	Interval	Duration
<i>Start-Up/Ramp-Up</i>	19:55:23	19:58:24	0-2	0:03:01
<i>Measurement Interval</i>	19:58:24	20:08:24	3-12	0:10:00
60 second intervals	All ASUs	ASU1	ASU2	ASU3
0	7.51	10.03	10.22	0.98
1	7.62	10.15	10.40	1.05
2	7.69	10.23	10.41	1.10
3	7.67	10.22	10.45	1.03
4	7.62	10.16	10.37	1.03
5	7.63	10.18	10.38	1.03
6	7.62	10.16	10.37	1.03
7	7.63	10.15	10.36	1.06
8	7.61	10.16	10.35	1.01
9	7.62	10.15	10.35	1.04
10	7.60	10.15	10.33	1.02
11	7.62	10.16	10.37	1.03
12	7.58	10.11	10.32	1.01
<i>Average</i>	<i>7.62</i>	<i>10.16</i>	<i>10.37</i>	<i>1.03</i>

**IOPS Test Run – Average Response Time (ms) Distribution Graph**

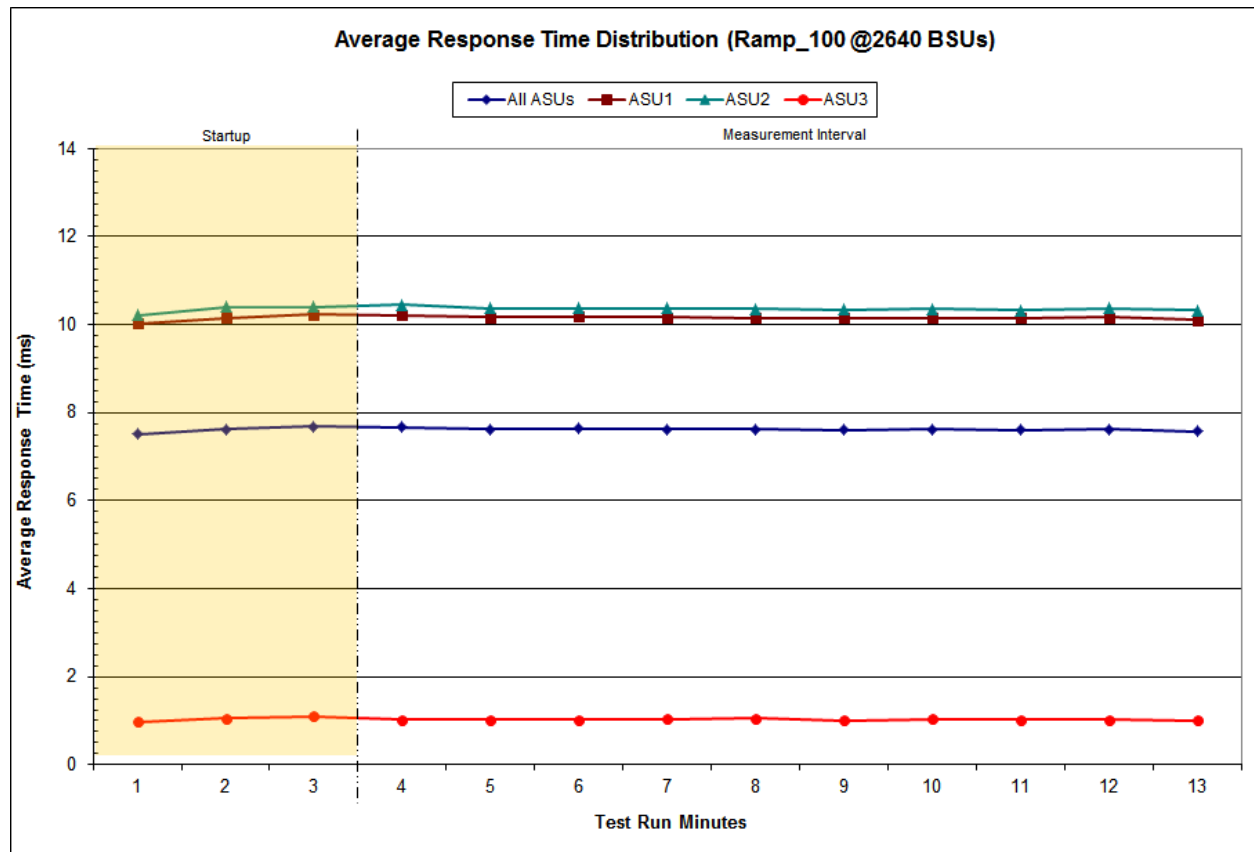



**IOPS Test Run –Response Time Frequency Distribution Data**

Response Time (ms)	0-0.25	>0.25-0.5	>0.5-0.75	>0.75-1.0	>1.0-1.25	>1.25-1.5	>1.5-1.75	>1.75-2.0
Read	283,029	983,794	1,238,842	276,963	110,836	108,747	138,117	167,057
Write	878	15,839,264	24,579,877	4,770,567	1,151,740	313,512	96,202	29,968
All ASUs	283,907	16,823,058	25,818,719	5,047,530	1,262,576	422,259	234,319	197,025
ASU1	264,926	7,672,471	10,410,514	2,540,097	948,889	338,678	195,441	171,569
ASU2	18,662	1,973,826	2,710,381	559,574	181,802	67,146	33,703	22,748
ASU3	319	7,176,761	12,697,824	1,947,859	131,885	16,435	5,175	2,708
Response Time (ms)	>2.0-2.5	>2.5-3.0	>3.0-3.5	>3.5-4.0	>4.0-4.5	>4.5-5.0	>5.0-6.0	>6.0-7.0
Read	395,581	569,501	629,102	834,514	947,228	1,140,616	2,095,046	1,774,670
Write	16,976	14,238	13,847	16,948	16,864	22,596	45,316	44,146
All ASUs	412,557	583,739	642,949	851,462	964,092	1,163,212	2,140,362	1,818,816
ASU1	363,767	515,590	565,366	748,569	847,715	1,020,658	1,861,953	1,572,054
ASU2	45,508	65,134	74,438	99,416	112,895	138,627	270,296	238,507
ASU3	3,282	3,015	3,145	3,477	3,482	3,927	8,113	8,255
Response Time (ms)	>7.0-8.0	>8.0-9.0	>9.0-10.0	>10.0-15.0	>15.0-20.0	>20.0-25.0	>25.0-30.0	>30.0
Read	1,549,239	1,204,996	1,083,208	3,992,486	2,713,983	1,999,194	1,532,474	5,466,052
Write	43,259	41,106	38,668	153,646	114,761	91,588	75,980	423,801
All ASUs	1,592,498	1,246,102	1,121,876	4,146,132	2,828,744	2,090,782	1,608,454	5,889,853
ASU1	1,376,591	1,071,348	965,498	3,552,782	2,408,370	1,763,704	1,342,549	4,674,597
ASU2	208,264	167,588	149,850	564,964	396,565	306,165	247,625	1,089,061
ASU3	7,643	7,166	6,528	28,386	23,809	20,913	18,280	126,195

**IOPS Test Run –Response Time Frequency Distribution Graph**

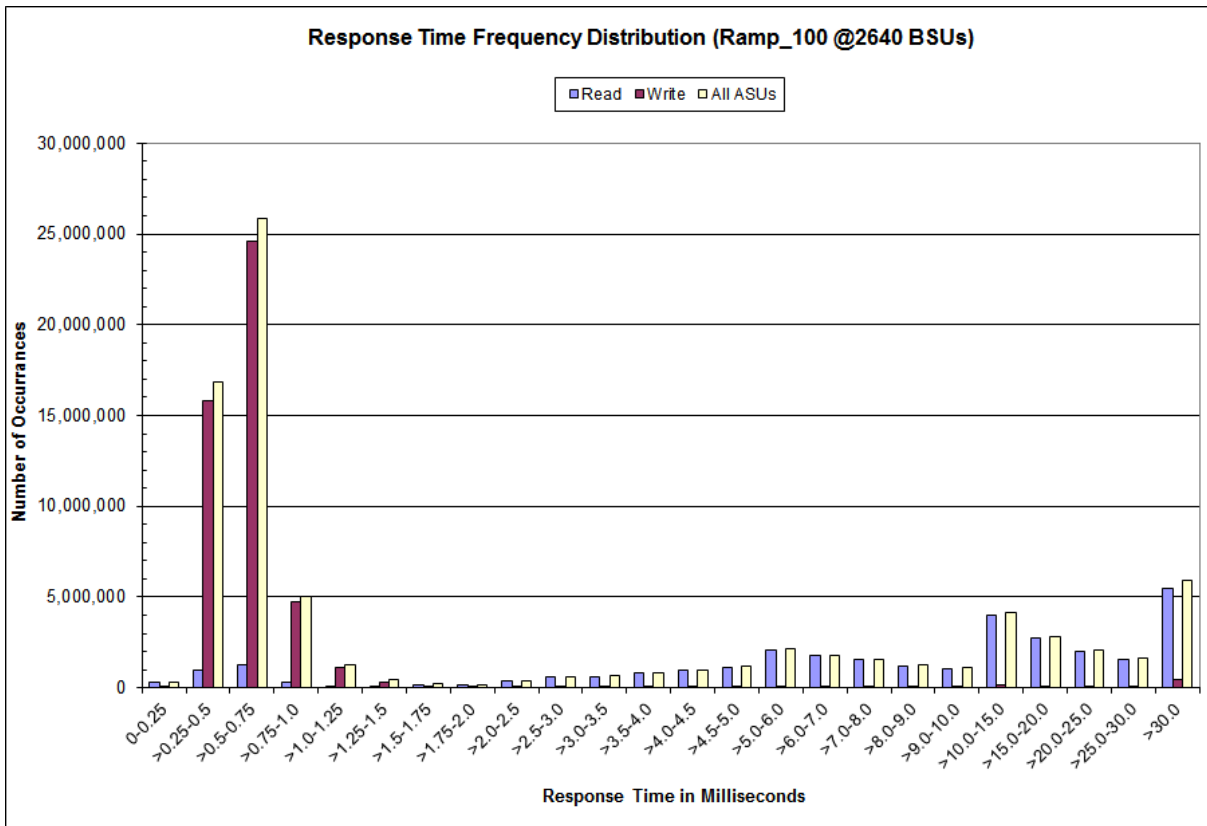

### IOPS Test Run – I/O Request Information

<b>I/O Requests Completed in the Measurement Interval</b>
79,191,023
<b>I/O Requests Completed with Response Time = or &lt; 30 ms</b>
73,301,170
<b>I/O Requests Completed with Response Time &gt; 30 ms</b>
5,889,853

### IOPS Test Run – Measured Intensity Multiplier and Coefficient of Variation

Clause 3.4.3

**IM – Intensity Multiplier:** The ratio of I/Os for each I/O stream relative to the total I/Os for all I/O streams (ASU1-1 – ASU3-1) as required by the benchmark specification.

Clauses 5.1.10 and 5.3.15.2

**MIM – Measured Intensity Multiplier:** The Measured Intensity Multiplier represents the ratio of measured I/Os for each I/O stream relative to the total I/Os measured for all I/O streams (ASU1-1 – ASU3-1). This value may differ from the corresponding Expected Intensity Multiplier by no more than 5%.

Clause 5.3.15.3

**COV – Coefficient of Variation:** This measure of variation for the Measured Intensity Multiplier cannot exceed 0.2.

	ASU1-1	ASU1-2	ASU1-3	ASU1-4	ASU2-1	ASU2-2	ASU2-3	ASU3-1
<b>IM</b>	<b>0.0350</b>	<b>0.2810</b>	<b>0.0700</b>	<b>0.2100</b>	<b>0.0180</b>	<b>0.0700</b>	<b>0.0350</b>	<b>0.2810</b>
MIM	0.0350	0.2809	0.0700	0.2100	0.0180	0.0700	0.0350	0.2810
COV	0.001	0.001	0.001	0.000	0.003	0.001	0.002	0.001

## Primary Metrics Test – Response Time Ramp Test Phase

### Clause 5.4.4.3

*The Response Time Ramp Test Phase consists of five Test Runs, one each at 95%, 90%, 80%, 50%, and 10% of the load point (100%) used to generate the SPC-1 IOPS™ primary metric. Each of the five Test Runs has a Measurement Interval of ten (10) minutes. The Response Time Ramp Test Phase immediately follows the IOPS Test Phase without any interruption or manual intervention.*

*The five Response Time Ramp Test Runs, in conjunction with the IOPS Test Run (100%), demonstrate the relationship between Average Response Time and I/O Request Throughput for the Tested Storage Configuration (TSC) as illustrated in the response time/throughput curve on page 16.*

*In addition, the Average Response Time measured during the 10% Test Run is the value for the SPC-1 LRT™ metric. That value represents the Average Response Time of a lightly loaded TSC.*

### Clause 9.4.3.7.4

*The following content shall appear in the FDR for the Response Time Ramp Phase:*

- 1. A Response Time Ramp Distribution.*
- 2. The human readable Test Run Results File produced by the Workload Generator for each Test Run within the Response Time Ramp Test Phase.*
- 3. For the 10% Load Level Test Run (SPC-1 LRT™ metric) an Average Response Time Distribution.*
- 4. A listing or screen image of all input parameters supplied to the Workload Generator.*

## SPC-1 Workload Generator Input Parameters

The SPC-1 Workload Generator input parameters for the Sustainability, IOPS, Response Time Ramp, Repeatability, and Persistence Test Runs are documented in [Appendix E: SPC-1 Workload Generator Input Parameters](#) on Page [73](#).

## Response Time Ramp Test Results File

A link to each test result file generated from each Response Time Ramp Test Run list listed below.

[95% Load Level](#)

[90% Load Level](#)

[80% Load Level](#)

[50% Load Level](#)

[10% Load Level](#)

### Response Time Ramp Distribution (IOPS) Data

The five Test Runs that comprise the Response Time Ramp Phase are executed at 95%, 90%, 80%, 50%, and 10% of the Business Scaling Unit (BSU) load level used to produce the SPC-1 IOPS™ primary metric. The 100% BSU load level is included in the following Response Time Ramp data table and graph for completeness.

100% Load Level: 2,640 BSUs					95% Load Level: 2,508 BSUs				
	Start	Stop	Interval	Duration		Start	Stop	Interval	Duration
Start-Up/Ramp-Up	19:55:23	19:58:24	0-3	0:03:01	Start-Up/Ramp-Up	20:09:41	20:12:42	0-3	0:03:01
Measurement Interval	19:58:24	20:08:24	3-12	0:10:00	Measurement Interval	20:12:42	20:22:42	3-12	0:10:00
(60 second intervals)	All ASUs	ASU-1	ASU-2	ASU-3	(60 second intervals)	All ASUs	ASU-1	ASU-2	ASU-3
0	132,085.83	78,703.23	16,257.60	37,125.00	0	125,406.22	74,727.13	15,409.10	35,269.98
1	131,995.55	78,691.20	16,237.92	37,066.43	1	125,458.62	74,780.32	15,433.30	35,245.00
2	131,903.55	78,623.03	16,210.02	37,070.50	2	125,427.40	74,749.63	15,463.12	35,214.65
3	132,004.05	78,663.20	16,254.35	37,086.50	3	125,342.90	74,689.78	15,467.90	35,185.22
4	131,994.63	78,679.23	16,228.45	37,086.95	4	125,441.52	74,753.18	15,428.12	35,260.22
5	132,023.20	78,699.92	16,267.32	37,055.97	5	125,300.80	74,701.65	15,389.88	35,209.27
6	131,970.58	78,635.85	16,223.42	37,111.32	6	125,382.12	74,663.95	15,438.85	35,279.32
7	131,936.48	78,634.62	16,241.40	37,060.47	7	125,387.58	74,693.82	15,439.35	35,254.42
8	132,043.07	78,645.18	16,250.73	37,147.15	8	125,407.12	74,735.47	15,403.75	35,267.90
9	131,907.67	78,632.07	16,214.50	37,061.10	9	125,416.72	74,742.38	15,427.67	35,246.67
10	131,935.12	78,608.92	16,242.17	37,084.03	10	125,385.77	74,698.00	15,450.13	35,237.63
11	132,012.02	78,705.07	16,222.47	37,084.48	11	125,392.38	74,768.57	15,421.78	35,202.03
12	132,038.23	78,669.65	16,236.45	37,132.13	12	125,498.37	74,782.93	15,438.70	35,276.73
Average	131,986.51	78,657.37	16,238.13	37,091.01	Average	125,395.53	74,722.97	15,430.61	35,241.94
90% Load Level: 2,376 BSUs					80% Load Level: 2,112 BSUs				
	Start	Stop	Interval	Duration		Start	Stop	Interval	Duration
Start-Up/Ramp-Up	20:23:54	20:26:55	0-3	0:03:01	Start-Up/Ramp-Up	20:38:08	20:41:09	0-3	0:03:01
Measurement Interval	20:26:55	20:36:55	3-12	0:10:00	Measurement Interval	20:41:09	20:51:09	3-12	0:10:00
(60 second intervals)	All ASUs	ASU-1	ASU-2	ASU-3	(60 second intervals)	All ASUs	ASU-1	ASU-2	ASU-3
0	118,916.77	70,909.35	14,625.73	33,381.68	0	105,671.78	62,996.15	13,005.42	29,670.22
1	118,868.70	70,824.85	14,601.90	33,441.95	1	105,599.28	62,919.83	12,995.20	29,684.25
2	118,827.55	70,802.27	14,616.30	33,408.98	2	105,586.25	62,888.62	13,008.15	29,689.48
3	118,825.10	70,855.40	14,606.63	33,363.07	3	105,603.73	62,924.82	13,003.70	29,675.22
4	118,775.07	70,791.05	14,606.68	33,377.33	4	105,580.35	62,908.92	12,992.27	29,679.17
5	118,851.73	70,804.72	14,645.70	33,401.32	5	105,654.42	62,969.67	12,998.65	29,686.10
6	118,824.65	70,809.43	14,616.37	33,398.85	6	105,658.53	63,001.87	12,997.88	29,658.78
7	118,871.20	70,894.50	14,612.65	33,364.05	7	105,680.15	63,002.05	12,974.72	29,703.38
8	118,762.92	70,771.18	14,608.00	33,383.73	8	105,654.27	62,998.65	13,003.25	29,652.37
9	118,784.42	70,826.93	14,606.87	33,350.62	9	105,623.12	62,936.57	12,971.52	29,715.03
10	118,764.10	70,761.73	14,609.78	33,392.58	10	105,597.75	62,916.18	13,009.55	29,672.02
11	118,803.83	70,827.63	14,593.98	33,382.22	11	105,598.43	62,921.57	13,001.62	29,675.25
12	118,781.52	70,773.73	14,626.60	33,381.18	12	105,547.82	62,886.45	12,985.05	29,676.32
Average	118,804.45	70,811.63	14,613.33	33,379.50	Average	105,619.86	62,946.67	12,993.82	29,679.36

**Response Time Ramp Distribution (IOPS) Data (continued)**

50% Load Level: 1,320 BSUs					10% Load Level: 264 BSUs				
Start-Up/Ramp-Up Measurement Interval	Start	Stop	Interval	Duration	Start-Up/Ramp-Up Measurement Interval	Start	Stop	Interval	Duration
(60 second intervals)	All ASUs	ASU-1	ASU-2	ASU-3	(60 second intervals)	All ASUs	ASU-1	ASU-2	ASU-3
0	66,027.67	39,349.53	8,126.02	18,552.12	0	13,195.97	7,872.67	1,628.10	3,695.20
1	66,030.80	39,353.57	8,112.00	18,565.23	1	13,216.03	7,879.50	1,629.28	3,707.25
2	65,989.52	39,324.07	8,114.47	18,550.98	2	13,166.28	7,849.13	1,620.42	3,696.73
3	65,961.97	39,325.08	8,113.58	18,523.30	3	13,212.68	7,873.98	1,624.60	3,714.10
4	66,041.15	39,333.67	8,130.33	18,577.15	4	13,200.22	7,873.00	1,618.90	3,708.32
5	66,019.32	39,336.88	8,120.13	18,562.30	5	13,215.33	7,866.45	1,632.13	3,716.75
6	66,009.43	39,340.42	8,109.90	18,559.12	6	13,208.97	7,863.87	1,627.08	3,718.02
7	65,960.73	39,304.40	8,112.18	18,544.15	7	13,201.23	7,872.02	1,620.48	3,708.73
8	65,987.97	39,341.78	8,108.10	18,538.08	8	13,203.08	7,866.58	1,626.38	3,710.12
9	65,988.48	39,334.00	8,128.85	18,525.63	9	13,199.97	7,866.88	1,624.28	3,708.80
10	66,029.72	39,332.05	8,124.33	18,573.33	10	13,177.08	7,857.65	1,620.52	3,698.92
11	66,055.10	39,349.62	8,120.12	18,585.37	11	13,175.07	7,865.13	1,612.55	3,697.38
12	66,025.33	39,383.77	8,100.13	18,541.43	12	13,203.72	7,863.97	1,626.73	3,713.02
<b>Average</b>	<b>66,007.92</b>	<b>39,338.17</b>	<b>8,116.77</b>	<b>18,552.99</b>	<b>Average</b>	<b>13,199.74</b>	<b>7,866.95</b>	<b>1,623.37</b>	<b>3,709.42</b>

**Response Time Ramp Distribution (IOPS) Graph**

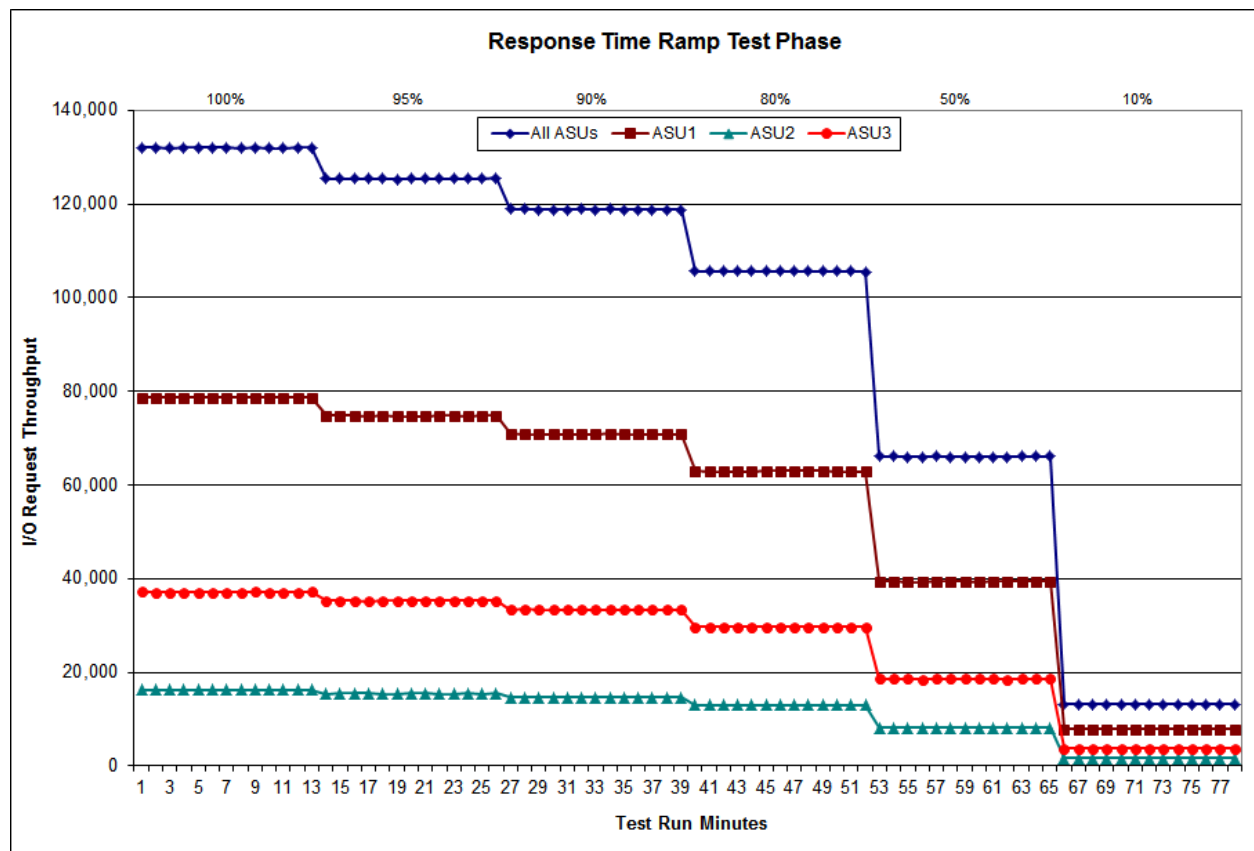

**SPC-1 LRT™ Average Response Time (ms) Distribution Data**

264 BSUs	Start	Stop	Interval	Duration
<b>Start-Up/Ramp-Up</b>	21:06:41	21:09:41	0-2	0:03:00
<b>Measurement Interval</b>	21:09:41	21:19:41	3-12	0:10:00
60 second intervals	All ASUs	ASU1	ASU2	ASU3
0	2.36	2.85	2.38	1.32
1	2.31	2.75	2.35	1.36
2	2.31	2.77	2.27	1.36
3	2.29	2.73	2.20	1.38
4	2.28	2.72	2.21	1.37
5	2.28	2.72	2.23	1.38
6	2.29	2.73	2.27	1.38
7	2.26	2.69	2.20	1.38
8	2.29	2.74	2.23	1.37
9	2.26	2.71	2.17	1.35
10	2.26	2.71	2.16	1.35
11	2.27	2.72	2.15	1.36
12	2.29	2.74	2.22	1.38
<b>Average</b>	<b>2.28</b>	<b>2.72</b>	<b>2.20</b>	<b>1.37</b>

**SPC-1 LRT™ Average Response Time (ms) Distribution Graph**

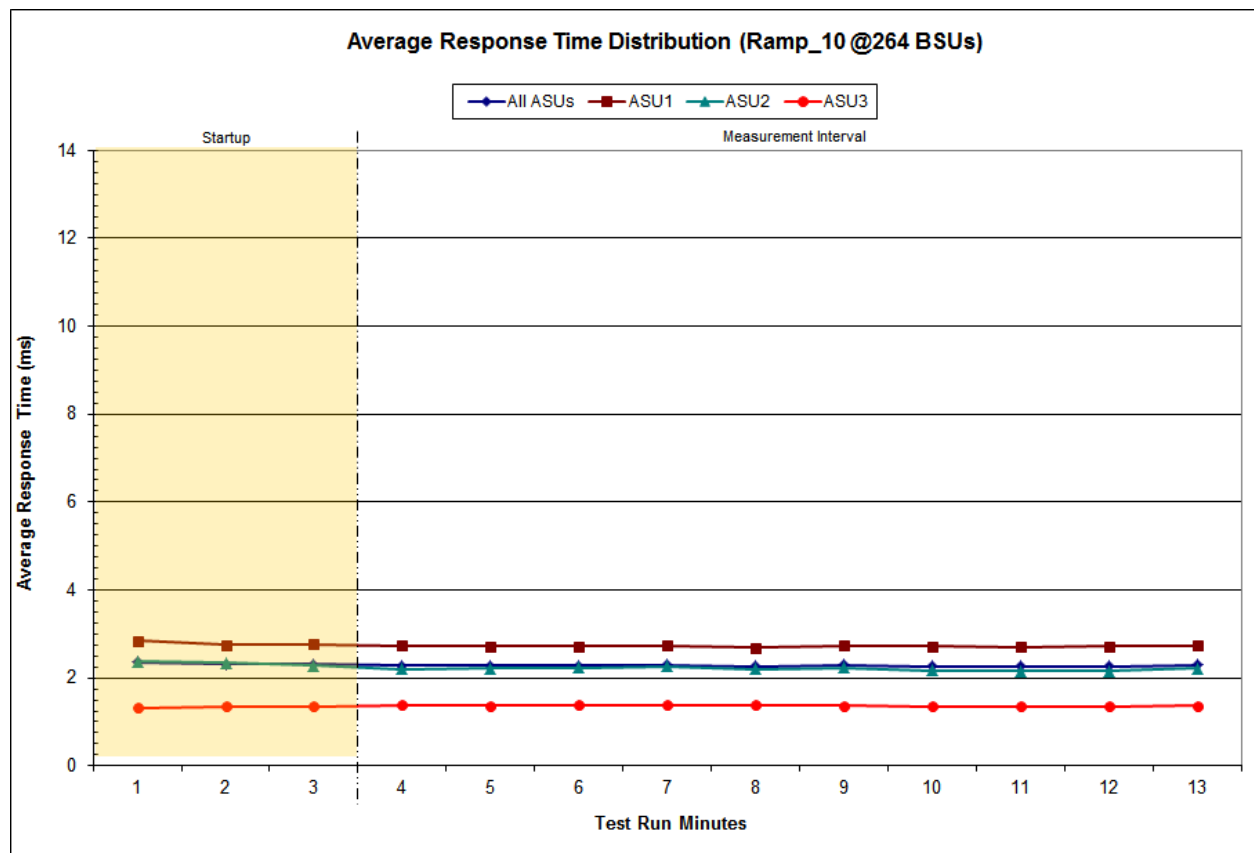

**SPC-1 LRT™ (10%) – Measured Intensity Multiplier and Coefficient of Variation**

Clause 3.4.3

**IM – Intensity Multiplier:** The ratio of I/Os for each I/O stream relative to the total I/Os for all I/O streams (ASU1-1 – ASU3-1) as required by the benchmark specification.

Clauses 5.1.10 and 5.3.15.2

**MIM – Measured Intensity Multiplier:** The Measured Intensity Multiplier represents the ratio of measured I/Os for each I/O stream relative to the total I/Os measured for all I/O streams (ASU1-1 – ASU3-1). This value may differ from the corresponding Expected Intensity Multiplier by no more than 5%.

Clause 5.3.15.3

**COV – Coefficient of Variation:** This measure of variation for the Measured Intensity Multiplier cannot exceed 0.2.

	ASU1-1	ASU1-2	ASU1-3	ASU1-4	ASU2-1	ASU2-2	ASU2-3	ASU3-1
<b>IM</b>	0.0350	0.2810	0.0700	0.2100	0.0180	0.0700	0.0350	0.2810
MIM	0.0349	0.2811	0.0701	0.2099	0.0180	0.0700	0.0350	0.2810
COV	0.005	0.002	0.005	0.001	0.008	0.003	0.008	0.001

## Repeatability Test

### Clause 5.4.5

*The Repeatability Test demonstrates the repeatability and reproducibility of the SPC-1 IOPS™ primary metric and the SPC-1 LRT™ metric generated in earlier Test Runs.*

*There are two identical Repeatability Test Phases. Each Test Phase contains two Test Runs. Each of the Test Runs will have a Measurement Interval of no less than ten (10) minutes. The two Test Runs in each Test Phase will be executed without interruption or any type of manual intervention.*

*The first Test Run in each Test Phase is executed at the 10% load point. The Average Response Time from each of the Test Runs is compared to the SPC-1 LRT™ metric. Each Average Response Time value must be less than the SPC-1 LRT™ metric plus 5% or less than the SPC-1 LRT™ metric plus one (1) millisecond (ms).*

*The second Test Run in each Test Phase is executed at the 100% load point. The I/O Request Throughput from the Test Runs is compared to the SPC-1 IOPS™ primary metric. Each I/O Request Throughput value must be greater than the SPC-1 IOPS™ primary metric minus 5%. In addition, the Average Response Time for each Test Run cannot exceed 30 milliseconds.*

*If any of the above constraints are not met, the benchmark measurement is invalid.*

### Clause 9.4.3.7.5

*The following content shall appear in the FDR for each Test Run in the two Repeatability Test Phases:*

- 1. A table containing the results of the Repeatability Test.*
- 2. An I/O Request Throughput Distribution graph and table.*
- 3. An Average Response Time Distribution graph and table.*
- 4. The human readable Test Run Results File produced by the Workload Generator.*
- 5. A listing or screen image of all input parameters supplied to the Workload Generator.*

## SPC-1 Workload Generator Input Parameters

The SPC-1 Workload Generator input parameters for the Sustainability, IOPS, Response Time Ramp, Repeatability, and Persistence Test Runs are documented in [Appendix E: SPC-1 Workload Generator Input Parameters](#) on Page [73](#).



**Repeatability Test Results File**

The values for the SPC-1 IOPS™, SPC-1 LRT™, and the Repeatability Test measurements are listed in the tables below.

	<b>SPC-1 IOPS™</b>
<b>Primary Metrics</b>	<b>131,986.51</b>
<b>Repeatability Test Phase 1</b>	132,010.10
<b>Repeatability Test Phase 2</b>	132,006.33

The SPC-1 IOPS™ values in the above table were generated using 100% of the specified Business Scaling Unit (BSU) load level. Each of the Repeatability Test Phase values for SPC-1 IOPS™ must be greater than 95% of the reported SPC-1 IOPS™ Primary Metric.

	<b>SPC-1 LRT™</b>
<b>Primary Metrics</b>	<b>2.28</b>
<b>Repeatability Test Phase 1</b>	2.28
<b>Repeatability Test Phase 2</b>	2.27

The average response time values in the SPC-1 LRT™ column were generated using 10% of the specified Business Scaling Unit (BSU) load level. Each of the Repeatability Test Phase values for SPC-1 LRT™ must be less than 105% of the reported SPC-1 LRT™ Primary Metric or less than the reported SPC-1 LRT™ Primary Metric plus one (1) millisecond (ms).

A link to the test result file generated from each Repeatability Test Run is listed below.

- [Repeatability Test Phase 1, Test Run 1 \(LRT\)](#)
- [Repeatability Test Phase 1, Test Run 2 \(IOPS\)](#)
- [Repeatability Test Phase 2, Test Run 1 \(LRT\)](#)
- [Repeatability Test Phase 2, Test Run 2 \(IOPS\)](#)

**Repeatability 1 LRT – I/O Request Throughput Distribution Data**

264 BSUs	Start	Stop	Interval	Duration
<i>Start-Up/Ramp-Up</i>	21:21:02	21:24:02	0-2	0:03:00
<i>Measurement Interval</i>	21:24:02	21:34:02	3-12	0:10:00
60 second intervals	All ASUs	ASU1	ASU2	ASU3
0	13,206.92	7,865.82	1,624.18	3,716.92
1	13,203.63	7,866.38	1,631.60	3,705.65
2	13,180.75	7,846.35	1,625.40	3,709.00
3	13,186.50	7,861.67	1,609.80	3,715.03
4	13,215.42	7,886.87	1,616.07	3,712.48
5	13,188.22	7,875.45	1,611.43	3,701.33
6	13,176.85	7,837.37	1,622.27	3,717.22
7	13,221.25	7,871.58	1,624.23	3,725.43
8	13,176.17	7,848.50	1,622.57	3,705.10
9	13,207.05	7,869.55	1,616.05	3,721.45
10	13,222.25	7,873.40	1,626.97	3,721.88
11	13,217.77	7,869.17	1,622.67	3,725.93
12	13,197.77	7,868.18	1,627.97	3,701.62
<b>Average</b>	<b>13,200.92</b>	<b>7,866.17</b>	<b>1,620.00</b>	<b>3,714.75</b>

**Repeatability 1 LRT – I/O Request Throughput Distribution Graph**

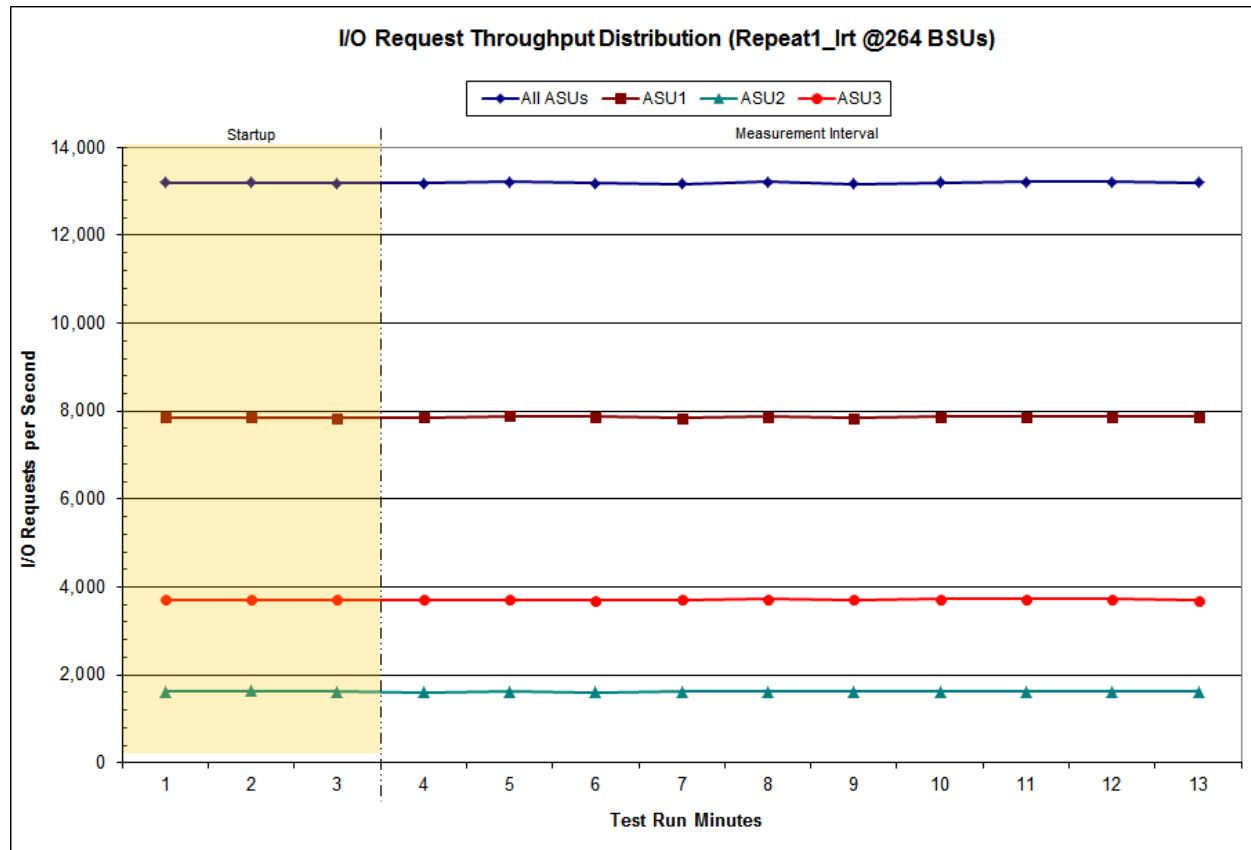

**Repeatability 1 LRT –Average Response Time (ms) Distribution Data**

264 BSUs Start-Up/Ramp-Up Measurement Interval	Start	Stop	Interval	Duration
	21:21:02	21:24:02	0-2	0:03:00
	21:24:02	21:34:02	3-12	0:10:00
60 second intervals	All ASUs	ASU1	ASU2	ASU3
0	2.35	2.84	2.34	1.31
1	2.33	2.79	2.32	1.36
2	2.43	2.86	2.37	1.55
3	2.27	2.72	2.12	1.36
4	2.28	2.72	2.16	1.39
5	2.28	2.73	2.17	1.37
6	2.26	2.71	2.16	1.35
7	2.27	2.72	2.11	1.38
8	2.28	2.74	2.17	1.37
9	2.29	2.74	2.19	1.40
10	2.29	2.74	2.19	1.39
11	2.27	2.71	2.17	1.39
12	2.28	2.73	2.14	1.38
<b>Average</b>	<b>2.28</b>	<b>2.73</b>	<b>2.16</b>	<b>1.38</b>

**Repeatability 1 LRT –Average Response Time (ms) Distribution Graph**

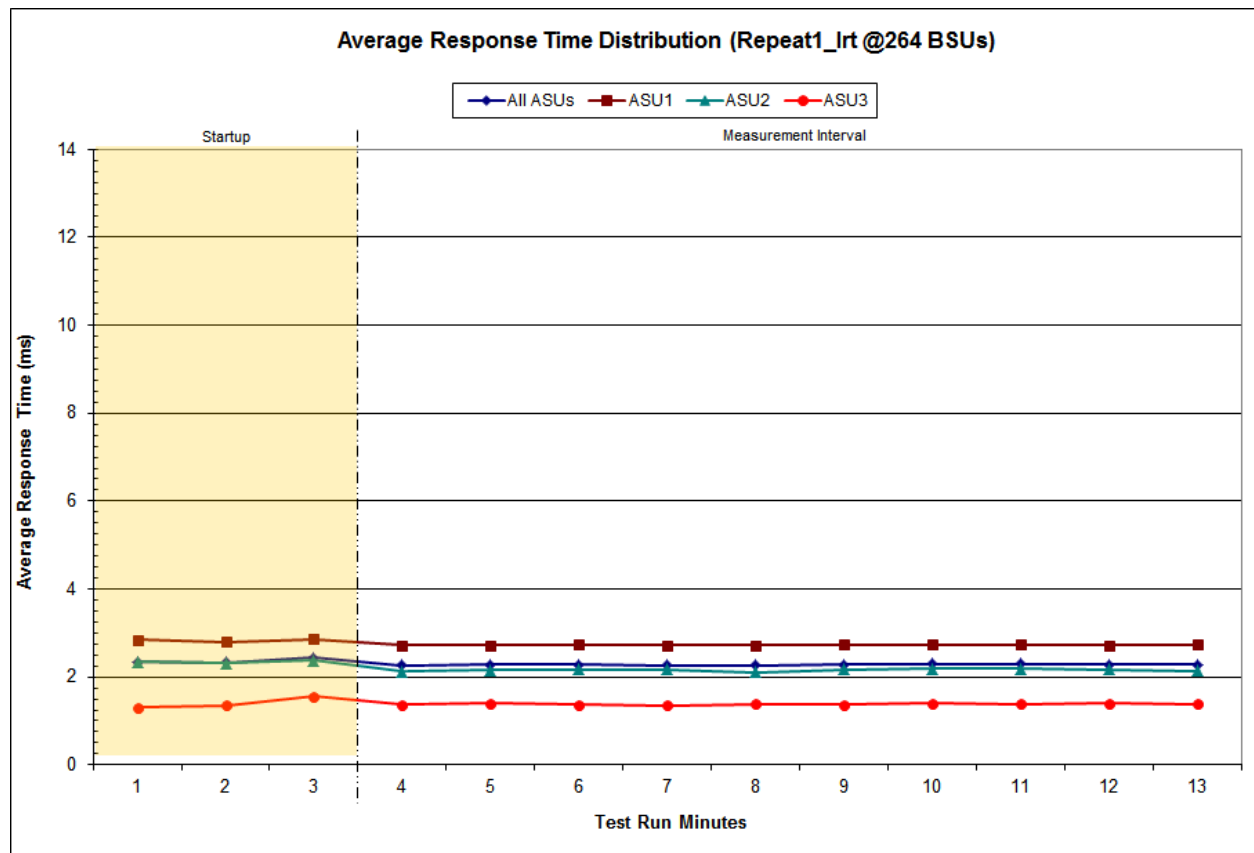

**Repeatability 1 IOPS – I/O Request Throughput Distribution Data**

2,640 BSUs Start-Up/Ramp-Up Measurement Interval	Start	Stop	Interval	Duration
	21:35:16	21:38:17	0-2	0:03:01
	21:38:17	21:48:17	3-12	0:10:00
60 second intervals	All ASUs	ASU1	ASU2	ASU3
0	131,938.68	78,633.12	16,228.90	37,076.67
1	132,017.57	78,647.73	16,276.73	37,093.10
2	132,038.63	78,690.97	16,233.82	37,113.85
3	132,076.62	78,710.70	16,250.83	37,115.08
4	132,054.72	78,728.40	16,233.50	37,092.82
5	131,922.30	78,637.68	16,225.32	37,059.30
6	132,025.22	78,707.20	16,218.55	37,099.47
7	131,968.17	78,641.77	16,223.48	37,102.92
8	131,964.58	78,627.22	16,239.42	37,097.95
9	131,998.08	78,653.98	16,257.27	37,086.83
10	132,012.92	78,638.13	16,233.93	37,140.85
11	132,021.25	78,674.47	16,234.95	37,111.83
12	132,057.18	78,732.12	16,228.27	37,096.80
<b>Average</b>	<b>132,010.10</b>	<b>78,675.17</b>	<b>16,234.55</b>	<b>37,100.39</b>

**Repeatability 1 IOPS – I/O Request Throughput Distribution Graph**

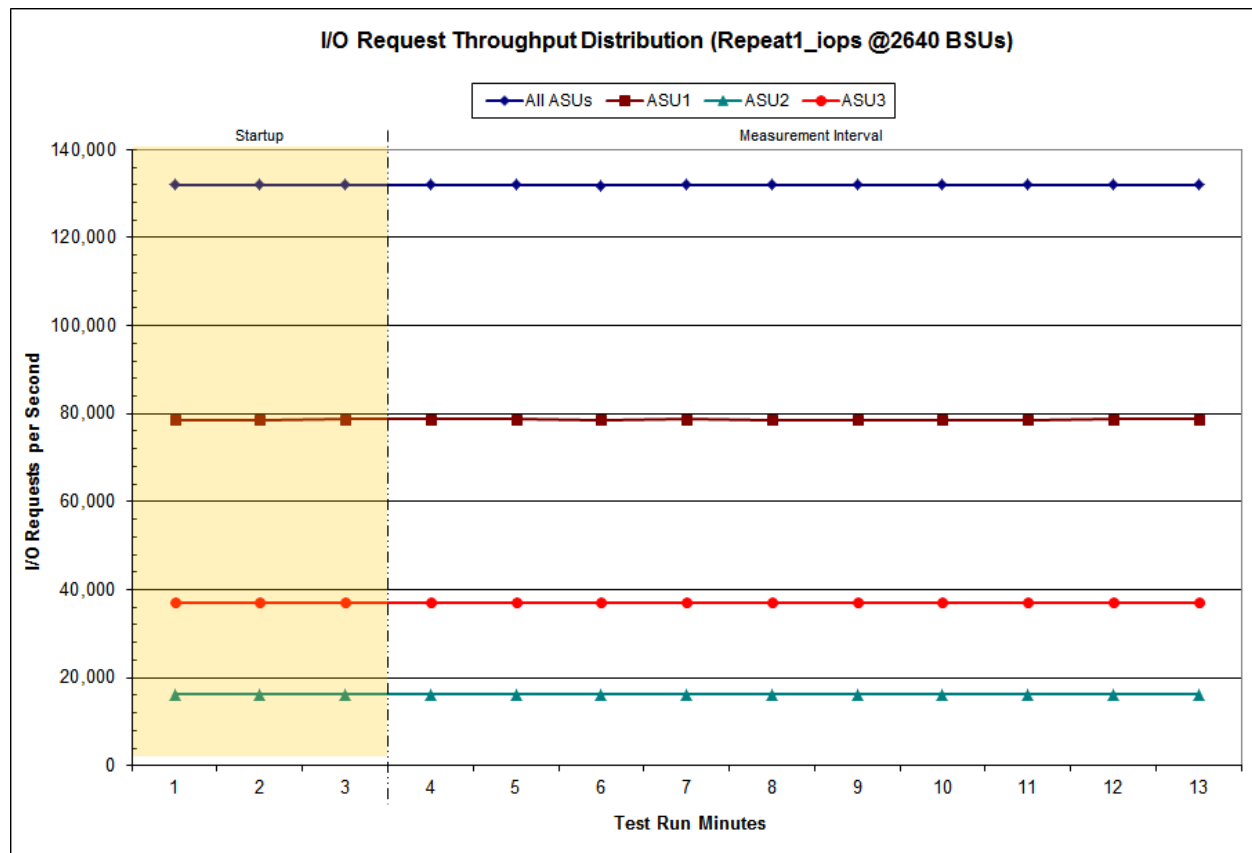

**Repeatability 1 IOPS –Average Response Time (ms) Distribution Data**

2,640 BSUs Start-Up/Ramp-Up Measurement Interval	Start	Stop	Interval	Duration
	21:35:16	21:38:17	0-2	0:03:01
	21:38:17	21:48:17	3-12	0:10:00
60 second intervals	All ASUs	ASU1	ASU2	ASU3
0	7.57	10.12	10.28	0.97
1	7.66	10.22	10.43	1.03
2	7.68	10.22	10.41	1.10
3	7.59	10.13	10.34	1.02
4	7.61	10.14	10.36	1.05
5	7.55	10.06	10.28	1.03
6	7.54	10.06	10.25	1.01
7	7.54	10.06	10.27	1.01
8	7.61	10.13	10.34	1.08
9	7.52	10.04	10.23	0.97
10	7.50	10.03	10.20	0.97
11	7.51	10.03	10.24	0.99
12	7.53	10.04	10.26	1.02
<b>Average</b>	<b>7.55</b>	<b>10.07</b>	<b>10.28</b>	<b>1.01</b>

**Repeatability 1 IOPS –Average Response Time (ms) Distribution Graph**

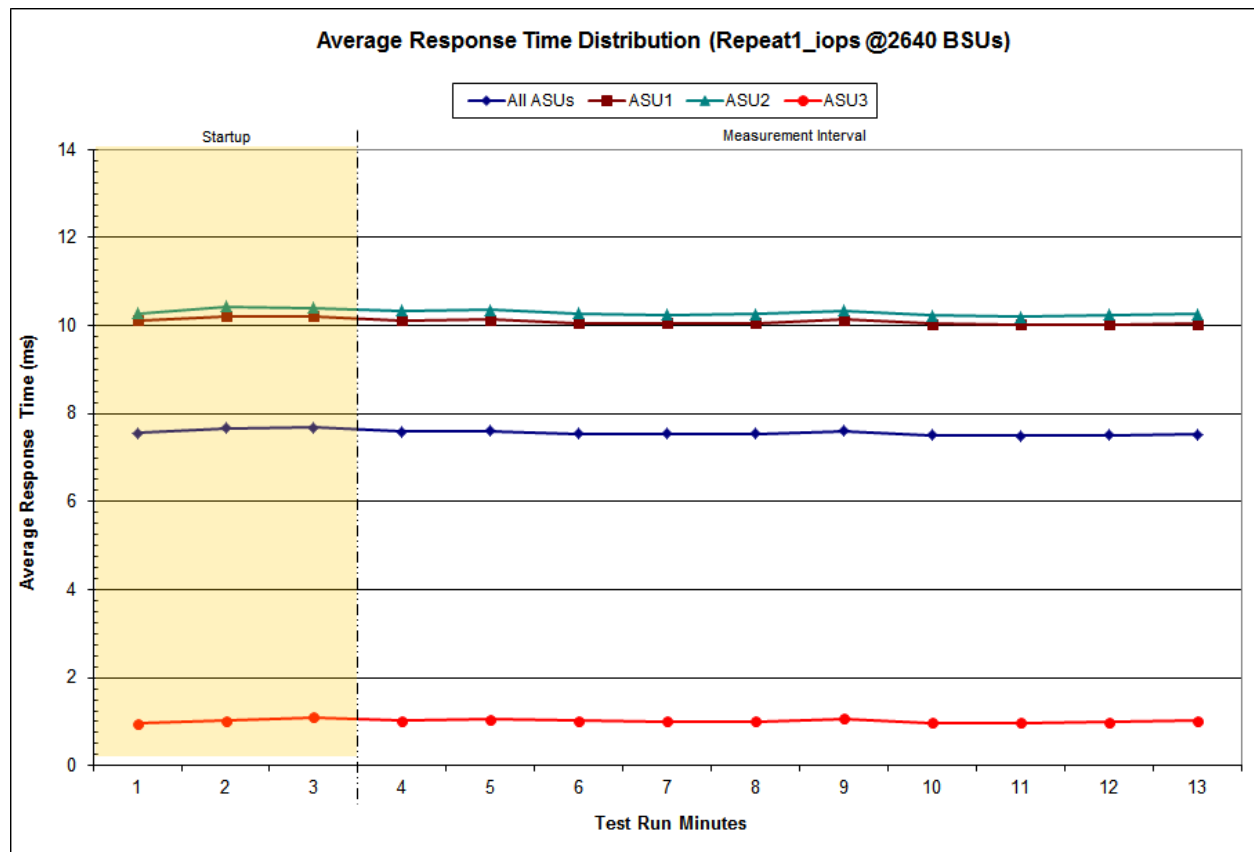

**Repeatability 2 LRT – I/O Request Throughput Distribution Data**

264 BSUs	Start	Stop	Interval	Duration
<i>Start-Up/Ramp-Up</i>	21:49:40	21:52:40	0-2	0:03:00
<i>Measurement Interval</i>	21:52:40	22:02:40	3-12	0:10:00
<b>60 second intervals</b>	<b>All ASUs</b>	<b>ASU1</b>	<b>ASU2</b>	<b>ASU3</b>
0	13,204.20	7,862.77	1,628.83	3,712.60
1	13,208.75	7,879.35	1,620.20	3,709.20
2	13,171.25	7,836.72	1,623.37	3,711.17
3	13,178.85	7,866.37	1,612.62	3,699.87
4	13,194.18	7,859.02	1,625.23	3,709.93
5	13,184.20	7,843.17	1,625.80	3,715.23
6	13,212.63	7,892.90	1,619.70	3,700.03
7	13,194.80	7,859.10	1,617.12	3,718.58
8	13,196.63	7,860.47	1,632.38	3,703.78
9	13,196.33	7,869.08	1,616.98	3,710.27
10	13,218.03	7,879.80	1,618.78	3,719.45
11	13,210.37	7,881.03	1,624.47	3,704.87
12	13,217.50	7,873.53	1,622.80	3,721.17
<b>Average</b>	<b>13,200.35</b>	<b>7,868.45</b>	<b>1,621.59</b>	<b>3,710.32</b>

**Repeatability 2 LRT – I/O Request Throughput Distribution Graph**

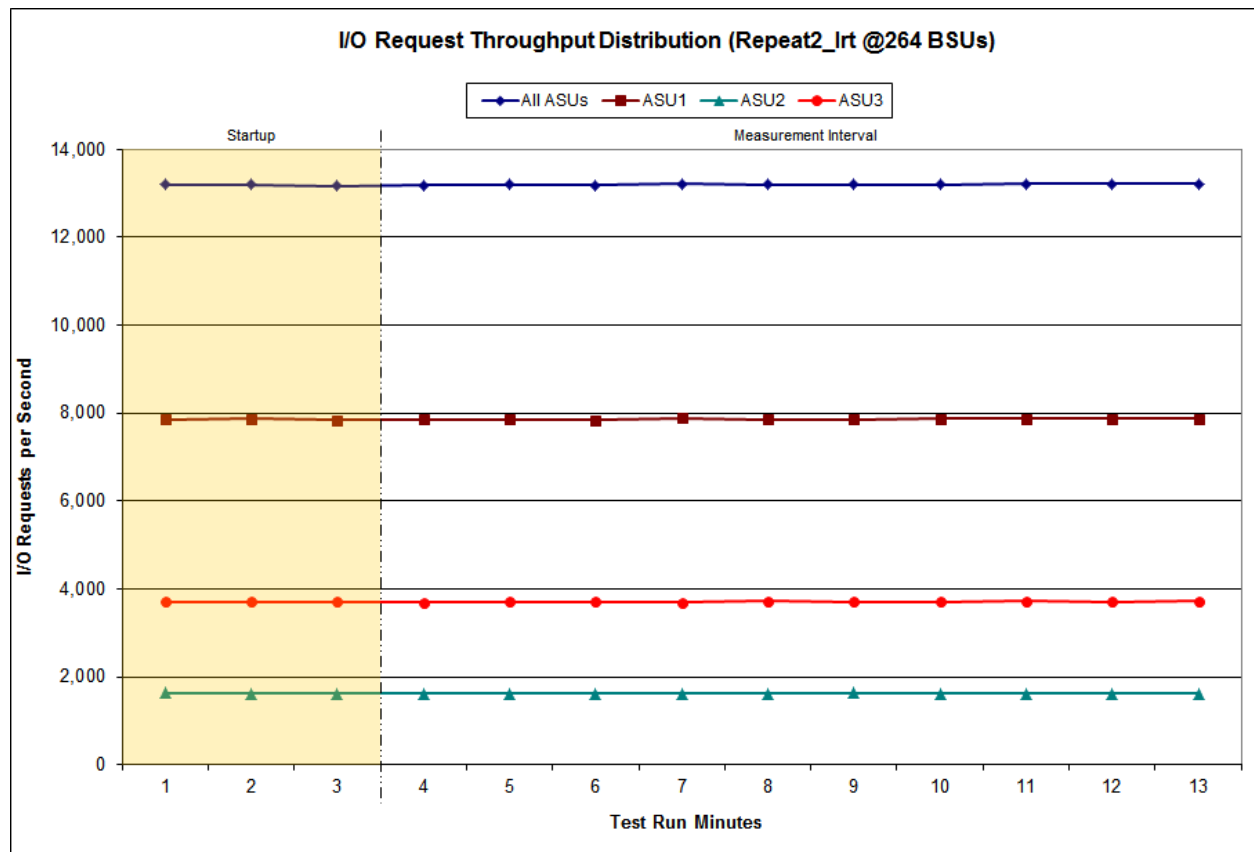

**Repeatability 2 LRT –Average Response Time (ms) Distribution Data**

264 BSUs Start-Up/Ramp-Up Measurement Interval	Start	Stop	Interval	Duration
	21:49:40	21:52:40	0-2	0:03:00
	21:52:40	22:02:40	3-12	0:10:00
60 second intervals	All ASUs	ASU1	ASU2	ASU3
0	2.37	2.86	2.39	1.33
1	2.33	2.79	2.31	1.37
2	2.29	2.74	2.25	1.36
3	2.31	2.77	2.21	1.39
4	2.25	2.70	2.18	1.32
5	2.28	2.74	2.23	1.33
6	2.30	2.74	2.28	1.37
7	2.26	2.71	2.20	1.33
8	2.25	2.69	2.19	1.36
9	2.28	2.72	2.23	1.36
10	2.28	2.73	2.18	1.36
11	2.25	2.68	2.16	1.36
12	2.24	2.69	2.12	1.35
<b>Average</b>	<b>2.27</b>	<b>2.72</b>	<b>2.20</b>	<b>1.35</b>

**Repeatability 2 LRT –Average Response Time (ms) Distribution Graph**

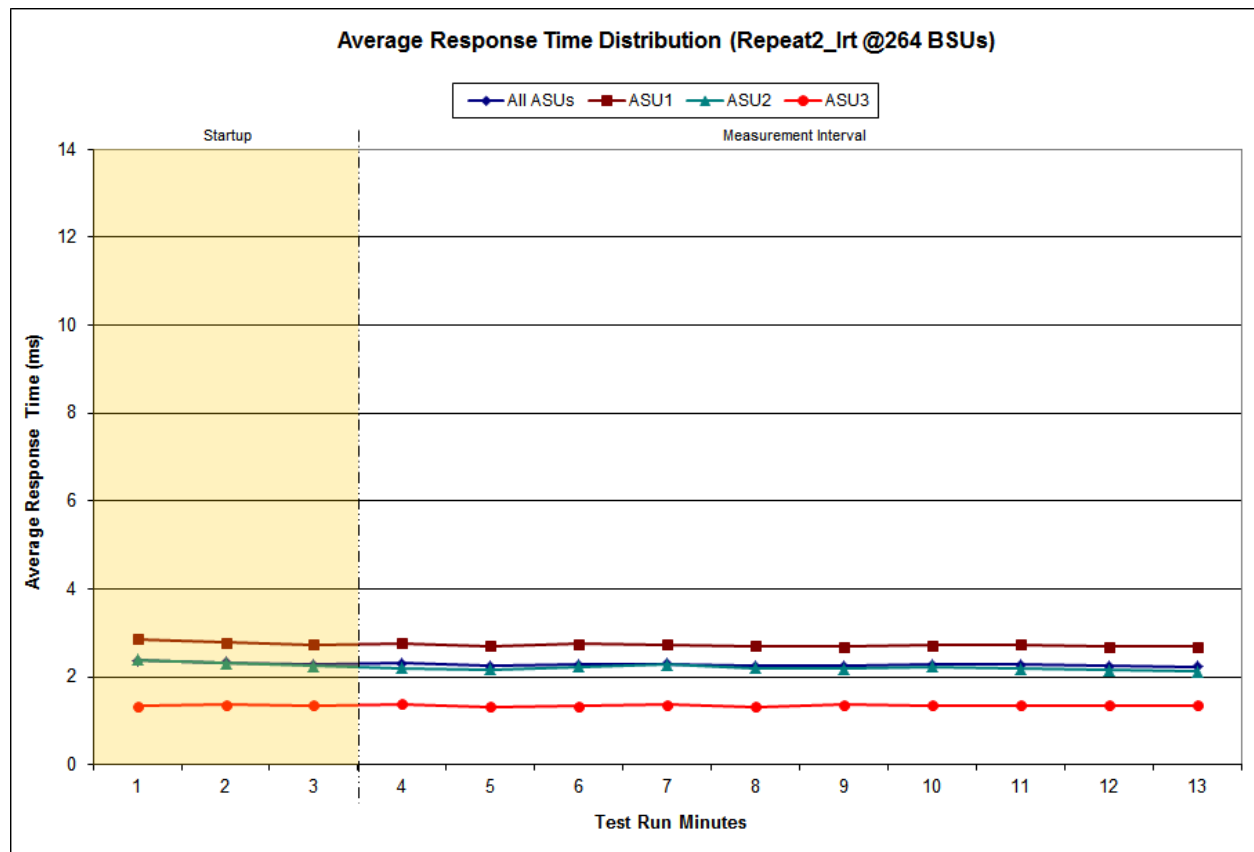

**Repeatability 2 IOPS – I/O Request Throughput Distribution Data**

2,640 BSUs	Start	Stop	Interval	Duration
<b>Start-Up/Ramp-Up</b>	22:03:57	22:06:58	0-2	0:03:01
<b>Measurement Interval</b>	22:06:58	22:16:58	3-12	0:10:00
<b>60 second intervals</b>	<b>All ASUs</b>	<b>ASU1</b>	<b>ASU2</b>	<b>ASU3</b>
0	132,042.92	78,678.18	16,260.18	37,104.55
1	131,956.08	78,644.53	16,243.82	37,067.73
2	132,033.12	78,736.25	16,228.03	37,068.83
3	131,995.17	78,692.77	16,213.40	37,089.00
4	132,073.20	78,767.55	16,224.23	37,081.42
5	132,022.65	78,661.30	16,238.50	37,122.85
6	132,068.32	78,734.30	16,235.27	37,098.75
7	131,899.07	78,588.95	16,231.45	37,078.67
8	132,000.67	78,695.17	16,236.90	37,068.60
9	131,943.23	78,613.68	16,232.67	37,096.88
10	132,069.98	78,736.28	16,273.00	37,060.70
11	132,014.37	78,705.67	16,223.63	37,085.07
12	131,976.60	78,660.33	16,234.27	37,082.00
<b>Average</b>	<b>132,006.33</b>	<b>78,685.60</b>	<b>16,234.33</b>	<b>37,086.39</b>

**Repeatability 2 IOPS – I/O Request Throughput Distribution Graph**

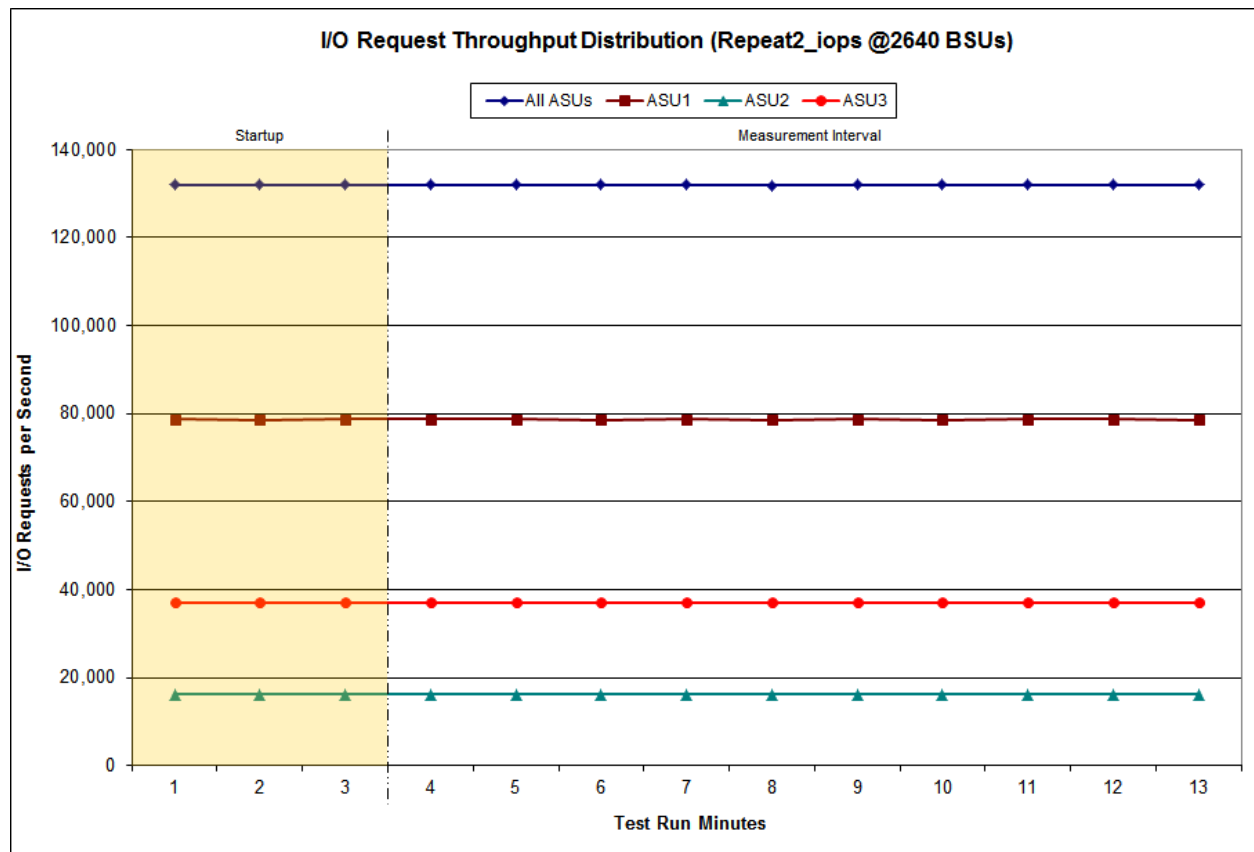



**Repeatability 2 IOPS –Average Response Time (ms) Distribution Data**

2,640 BSUs Start-Up/Ramp-Up Measurement Interval	Start	Stop	Interval	Duration
	22:03:57	22:06:58	0-2	0:03:01
	22:06:58	22:16:58	3-12	0:10:00
60 second intervals	All ASUs	ASU1	ASU2	ASU3
0	7.55	10.07	10.32	1.00
1	7.58	10.10	10.36	1.01
2	7.59	10.11	10.38	1.00
3	7.68	10.20	10.40	1.13
4	7.63	10.15	10.39	1.06
5	7.56	10.09	10.28	1.02
6	7.54	10.07	10.27	0.99
7	7.58	10.09	10.31	1.06
8	7.55	10.06	10.26	1.01
9	7.65	10.17	10.37	1.10
10	7.65	10.17	10.43	1.08
11	7.61	10.13	10.33	1.06
12	7.58	10.10	10.33	1.04
<b>Average</b>	<b>7.60</b>	<b>10.12</b>	<b>10.34</b>	<b>1.05</b>

**Repeatability 2 IOPS –Average Response Time (ms) Distribution Graph**

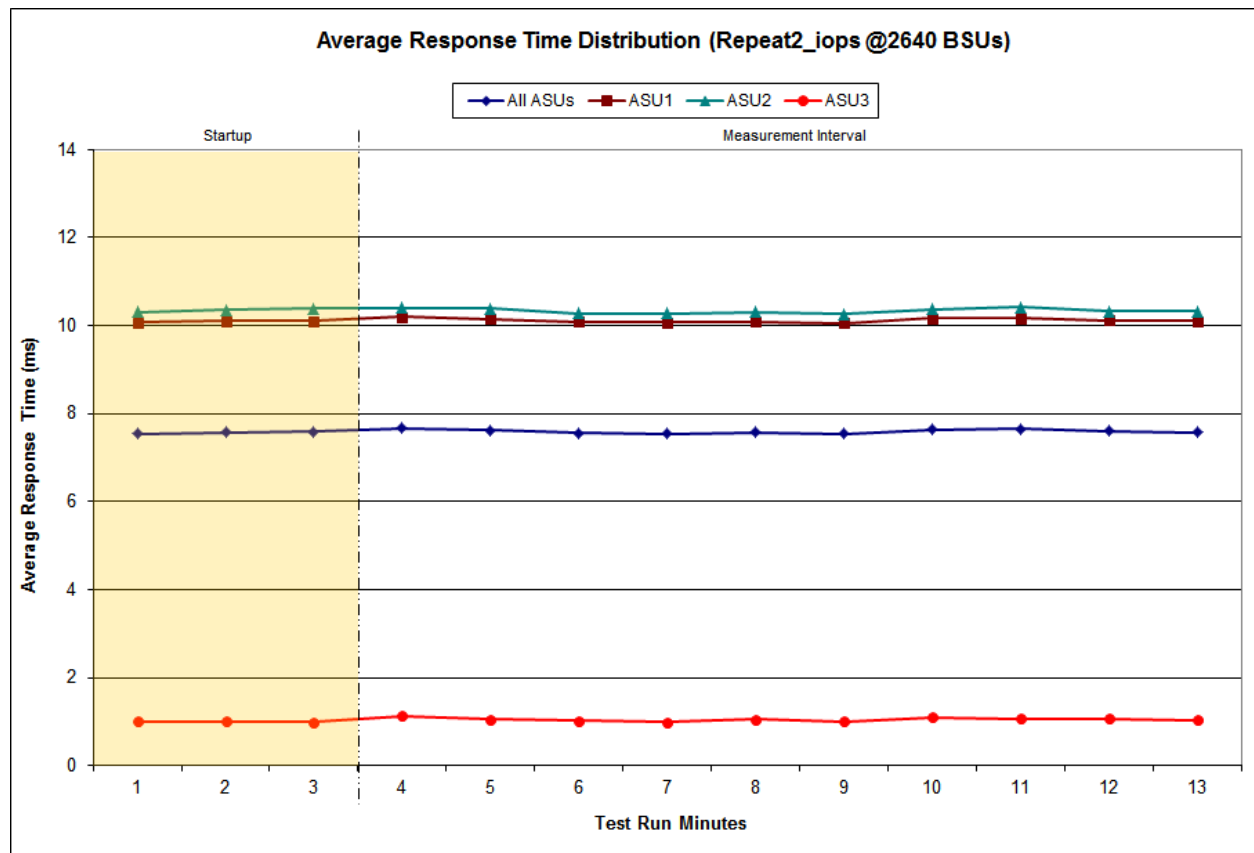

**Repeatability 1 (LRT)**  
**Measured Intensity Multiplier and Coefficient of Variation**

Clause 3.4.3

**IM – Intensity Multiplier:** The ratio of I/Os for each I/O stream relative to the total I/Os for all I/O streams (ASU1-1 – ASU3-1) as required by the benchmark specification.

Clauses 5.1.10 and 5.3.15.2

**MIM – Measured Intensity Multiplier:** The Measured Intensity Multiplier represents the ratio of measured I/Os for each I/O stream relative to the total I/Os measured for all I/O streams (ASU1-1 – ASU3-1). This value may differ from the corresponding Expected Intensity Multiplier by no more than 5%.

Clause 5.3.15.3

**COV – Coefficient of Variation:** This measure of variation for the Measured Intensity Multiplier cannot exceed 0.2.

	ASU1-1	ASU1-2	ASU1-3	ASU1-4	ASU2-1	ASU2-2	ASU2-3	ASU3-1
<b>IM</b>	<b>0.0350</b>	<b>0.2810</b>	<b>0.0700</b>	<b>0.2100</b>	<b>0.0180</b>	<b>0.0700</b>	<b>0.0350</b>	<b>0.2810</b>
MIM	0.0350	0.2809	0.0701	0.2098	0.0180	0.0698	0.0350	0.2814
COV	0.009	0.002	0.004	0.002	0.008	0.004	0.007	0.002

**Repeatability 1 (IOPS)**  
**Measured Intensity Multiplier and Coefficient of Variation**

	ASU1-1	ASU1-2	ASU1-3	ASU1-4	ASU2-1	ASU2-2	ASU2-3	ASU3-1
<b>IM</b>	<b>0.0350</b>	<b>0.2810</b>	<b>0.0700</b>	<b>0.2100</b>	<b>0.0180</b>	<b>0.0700</b>	<b>0.0350</b>	<b>0.2810</b>
MIM	0.0350	0.2810	0.0699	0.2100	0.0180	0.0700	0.0350	0.2810
COV	0.003	0.000	0.001	0.0001	0.003	0.001	0.001	0.000

**Repeatability 2 (LRT)**  
**Measured Intensity Multiplier and Coefficient of Variation**

	ASU1-1	ASU1-2	ASU1-3	ASU1-4	ASU2-1	ASU2-2	ASU2-3	ASU3-1
<b>IM</b>	<b>0.0350</b>	<b>0.2810</b>	<b>0.0700</b>	<b>0.2100</b>	<b>0.0180</b>	<b>0.0700</b>	<b>0.0350</b>	<b>0.2810</b>
MIM	0.0349	0.2812	0.0699	0.2100	0.0180	0.0699	0.0350	0.2811
COV	0.007	0.002	0.005	0.002	0.009	0.005	0.006	0.002

**Repeatability 2 (IOPS)**  
**Measured Intensity Multiplier and Coefficient of Variation**

	ASU1-1	ASU1-2	ASU1-3	ASU1-4	ASU2-1	ASU2-2	ASU2-3	ASU3-1
<i>IM</i>	<i>0.0350</i>	<i>0.2810</i>	<i>0.0700</i>	<i>0.2100</i>	<i>0.0180</i>	<i>0.0700</i>	<i>0.0350</i>	<i>0.2810</i>
MIM	0.0350	0.2810	0.0700	0.2100	0.0180	0.0700	0.0350	0.2809
COV	0.002	0.000	0.001	0.001	0.004	0.001	0.002	0.001

## Data Persistence Test

### Clause 6

*The Data Persistence Test demonstrates the Tested Storage Configuration (TSC):*

- *Is capable of maintain data integrity across a power cycle.*
- *Ensures the transfer of data between Logical Volumes and host systems occurs without corruption or loss.*

*The SPC-1 Workload Generator will write 16 block I/O requests at random over the total Addressable Storage Capacity of the TSC for ten (10) minutes at a minimum of 25% of the load used to generate the SPC-1 IOPS™ primary metric. The bit pattern selected to be written to each block as well as the address of the block will be retained in a log file.*

*The Tested Storage Configuration (TSC) will be shutdown and restarted using a power off/power on cycle at the end of the above sequence of write operations. In addition, any caches employing battery backup must be flushed/emptied.*

*The SPC-1 Workload Generator will then use the above log file to verify each block written contains the correct bit pattern.*

### Clause 9.4.3.8

*The following content shall appear in this section of the FDR:*

1. *A listing or screen image of all input parameters supplied to the Workload Generator.*
2. *For the successful Data Persistence Test Run, a table illustrating key results. The content, appearance, and format of this table are specified in Table 9-12. Information displayed in this table shall be obtained from the Test Run Results File referenced below in #3.*
3. *For the successful Data Persistence Test Run, the human readable Test Run Results file produced by the Workload Generator (may be contained in an appendix).*

## SPC-1 Workload Generator Input Parameters

The SPC-1 Workload Generator input parameters for the Sustainability, IOPS, Response Time Ramp, Repeatability, and Persistence Test Runs are documented in [Appendix E: SPC-1 Workload Generator Input Parameters](#) on Page [73](#).

## Data Persistence Test Results File

A link to each test result file generated from each Data Persistence Test is listed below.

[Persistence 1 Test Results File](#)

[Persistence 2 Test Results File](#)

### Data Persistence Test Results

Data Persistence Test Results	
Data Persistence Test Run Number: 1	
Total Number of Logical Blocks Written	316,793.888
Total Number of Logical Blocks Verified	167,575,200
Total Number of Logical Blocks that Failed Verification	0
Time Duration for Writing Test Logical Blocks	10 minutes
Size in bytes of each Logical Block	512
Number of Failed I/O Requests in the process of the Test	0

In some cases the same address was the target of multiple writes, which resulted in more Logical Blocks Written than Logical Blocks Verified. In the case of multiple writes to the same address, the pattern written and verified must be associated with the last write to that address.

## **PRICED STORAGE CONFIGURATION AVAILABILITY DATE**

### **Clause 9.4.3.9**

*The committed delivery data for general availability (Availability Date) of all products that comprise the Priced Storage Configuration must be reported. When the Priced Storage Configuration includes products or components with different availability dates, the reported Availability Date for the Priced Storage Configuration must be the date at which all components are committed to be available.*

The NEC Storage M310 as documented in this Full Disclosure Report is currently available for customer purchase and shipment.

## **PRICING INFORMATION**

### **Clause 9.4.3.3.6**

*The Executive Summary shall contain a pricing spreadsheet as documented in Clause 8.3.1.*

Pricing information may be found in the Priced Storage Configuration Pricing section on page [17](#).

## **TESTED STORAGE CONFIGURATION (TSC) AND PRICED STORAGE CONFIGURATION DIFFERENCES**

### **Clause 9.4.3.3.8**

*The Executive Summary shall contain a list of all differences between the Tested Storage Configuration (TSC) and the Priced Storage Configuration.*

A list of all differences between the Tested Storage Configuration (TSC) and Priced Storage Configuration may be found in the Executive Summary portion of this document on page [17](#).

## **ANOMALIES OR IRREGULARITIES**

### **Clause 9.4.3.10**

*The FDR shall include a clear and complete description of any anomalies or irregularities encountered in the course of executing the SPC-1 benchmark that may in any way call into question the accuracy, verifiability, or authenticity of information published in this FDR.*

There were no anomalies or irregularities encountered during the SPC-1 Remote Audit of the NEC Storage M310.

## **APPENDIX A: SPC-1 GLOSSARY**

### “Decimal” (*powers of ten*) Measurement Units

In the storage industry, the terms “kilo”, “mega”, “giga”, “tera”, “peta”, and “exa” are commonly used prefixes for computing performance and capacity. For the purposes of the SPC workload definitions, all of the following terms are defined in “powers of ten” measurement units.

A kilobyte (KB) is equal to 1,000 ( $10^3$ ) bytes.

A megabyte (MB) is equal to 1,000,000 ( $10^6$ ) bytes.

A gigabyte (GB) is equal to 1,000,000,000 ( $10^9$ ) bytes.

A terabyte (TB) is equal to 1,000,000,000,000 ( $10^{12}$ ) bytes.

A petabyte (PB) is equal to 1,000,000,000,000,000 ( $10^{15}$ ) bytes

An exabyte (EB) is equal to 1,000,000,000,000,000,000 ( $10^{18}$ ) bytes

### “Binary” (*powers of two*) Measurement Units

The sizes reported by many operating system components use “powers of two” measurement units rather than “power of ten” units. The following standardized definitions and terms are also valid and may be used in this document.

A kibibyte (KiB) is equal to 1,024 ( $2^{10}$ ) bytes.

A mebibyte (MiB) is equal to 1,048,576 ( $2^{20}$ ) bytes.

A gibibyte (GiB) is equal to 1,073,741,824 ( $2^{30}$ ) bytes.

A tebibyte (TiB) is equal to 1,099,511,627,776 ( $2^{40}$ ) bytes.

A pebibyte (PiB) is equal to 1,125,899,906,842,624 ( $2^{50}$ ) bytes.

An exbibyte (EiB) is equal to 1,152,921,504,606,846,967 ( $2^{60}$ ) bytes.

## **SPC-1 Data Repository Definitions**

**Total ASU Capacity:** The total storage capacity read and written in the course of executing the SPC-1 benchmark.

**Application Storage Unit (ASU):** The logical interface between the storage and SPC-1 Workload Generator. The three ASUs (Data, User, and Log) are typically implemented on one or more Logical Volume.

**Logical Volume:** The division of Addressable Storage Capacity into individually addressable logical units of storage used in the SPC-1 benchmark. Each Logical Volume is implemented as a single, contiguous address space.

**Addressable Storage Capacity:** The total storage (sum of Logical Volumes) that can be read and written by application programs such as the SPC-1 Workload Generator.

**Configured Storage Capacity:** This capacity includes the Addressable Storage Capacity and any other storage (parity disks, hot spares, etc.) necessary to implement the Addressable Storage Capacity.

**Physical Storage Capacity:** The formatted capacity of all storage devices physically present in the Tested Storage Configuration (TSC).

**Data Protection Overhead:** The storage capacity required to implement the selected level of data protection.

**Required Storage:** The amount of Configured Storage Capacity required to implement the Addressable Storage Configuration, excluding the storage required for the three ASUs.

**Global Storage Overhead:** The amount of Physical Storage Capacity that is required for storage subsystem use and unavailable for use by application programs.

**Total Unused Storage:** The amount of storage capacity available for use by application programs but not included in the Total ASU Capacity.

## SPC-1 Data Protection Levels

**Protected 1:** The single point of failure of any *storage device* in the configuration will not result in permanent loss of access to or integrity of the SPC-1 Data Repository.

**Protected 2:** The single point of failure of any *component* in the configuration will not result in permanent loss of access to or integrity of the SPC-1 Data Repository.

## SPC-1 Test Execution Definitions

**Average Response Time:** The sum of the Response Times for all Measured I/O Requests divided by the total number of Measured I/O Requests.

**Completed I/O Request:** An I/O Request with a Start Time and a Completion Time (see “I/O Completion Types” below).

**Completion Time:** The time recorded by the Workload Generator when an I/O Request is satisfied by the TSC as signaled by System Software.

**Data Rate:** The data transferred in all Measured I/O Requests in an SPC-1 Test Run divided by the length of the Test Run in seconds.

**Expected I/O Count:** For any given I/O Stream and Test Phase, the product of 50 times the BSU level, the duration of the Test Phase in seconds, and the Intensity Multiplier for that I/O Stream.

**Failed I/O Request:** Any I/O Request issued by the Workload Generator that could not be completed or was signaled as failed by System Software. A Failed I/O Request has no Completion Time (see “I/O Completion Types” below).



**I/O Request Throughput:** The total number of Measured I/O requests in an SPC-1 Test Run divided by the duration of the Measurement Interval in seconds.

**In-Flight I/O Request:** An I/O Request issued by the I/O Command Generator to the TSC that has a recorded Start Time, but does not complete within the Measurement Interval (see “I/O Completion Types” below).

**Measured I/O Request:** A Completed I/O Request with a Completion Time occurring within the Measurement Interval (see “I/O Completion Types” below).

**Measured Intensity Multiplier:** The percentage of all Measured I/O Requests that were issued by a given I/O Stream.

**Measurement Interval:** The finite and contiguous time period, after the TSC has reached Steady State, when data is collected by a Test Sponsor to generate an SPC-1 test result or support an SPC-1 test result.

**Ramp-Up:** The time required for the Benchmark Configuration (BC) to produce Steady State throughput after the Workload Generator begins submitting I/O Requests to the TSC for execution.

**Ramp-Down:** The time required for the BC to complete all I/O Requests issued by the Workload Generator. The Ramp-Down period begins when the Workload Generator ceases to issue new I/O Requests to the TSC.

**Response Time:** The Response Time of a Measured I/O Request is its Completion Time minus its Start Time.

**Start Time:** The time recorded by the Workload Generator when an I/O Request is submitted, by the Workload Generator, to the System Software for execution on the Tested Storage Configuration (TSC).

**Start-Up:** The period that begins after the Workload Generator starts to submit I/O requests to the TSC and ends at the beginning of the Measurement Interval.

**Shut-Down:** The period between the end of the Measurement Interval and the time when all I/O Requests issued by the Workload Generator have completed or failed.

**Steady State:** The consistent and sustainable throughput of the TSC. During this period the load presented to the TSC by the Workload Generator is constant.

**Test:** A collection of Test Phases and or Test Runs sharing a common objective.

**Test Run:** The execution of SPC-1 for the purpose of producing or supporting an SPC-1 test result. SPC-1 Test Runs may have a finite and measured Ramp-Up period, Start-Up period, Shut-Down period, and Ramp-Down period as illustrated in the “SPC-1 Test Run Components” below. All SPC-1 Test Runs shall have a Steady State period and a Measurement Interval.

**Test Phase:** A collection of one or more SPC-1 Test Runs sharing a common objective and intended to be run in a specific sequence.

**I/O Completion Types**

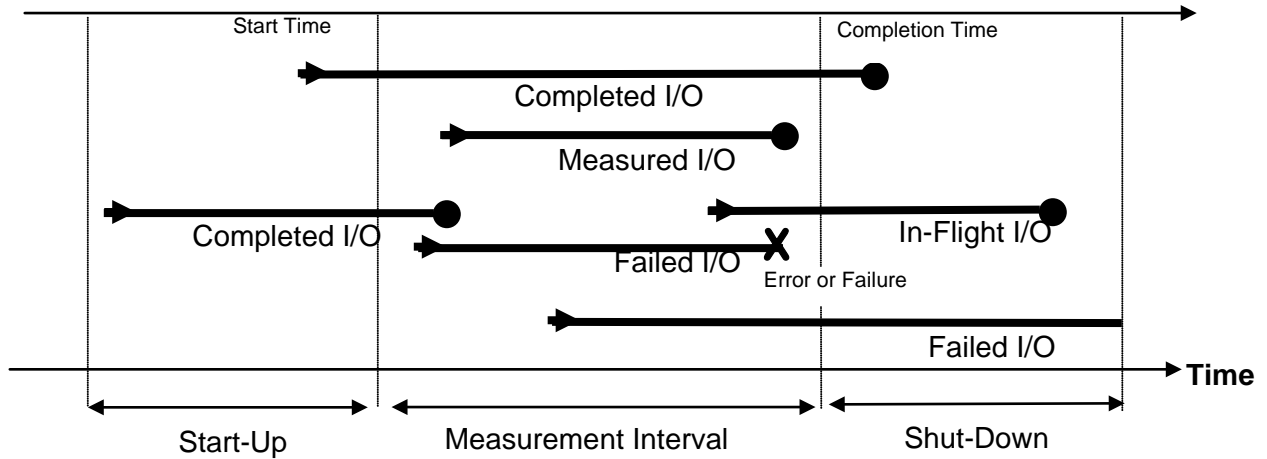

**SPC-1 Test Run Components**

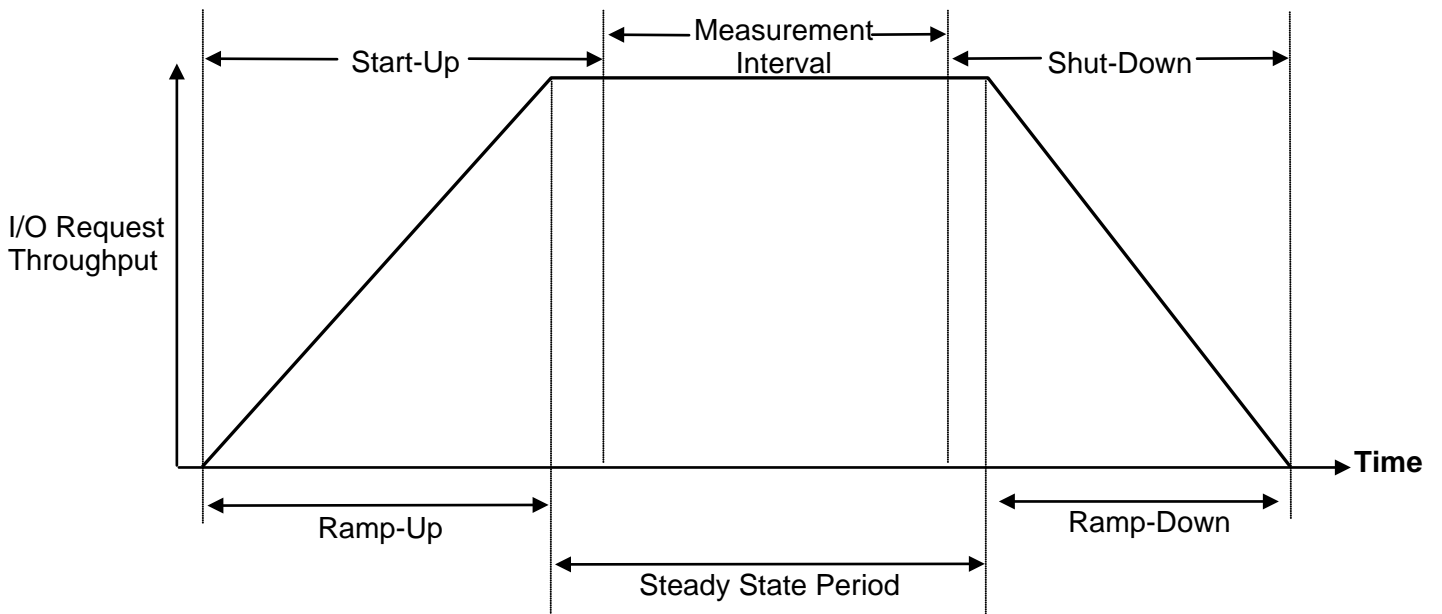

## **APPENDIX B: CUSTOMER TUNABLE PARAMETERS AND OPTIONS**

There were no customer tunable parameters or options changed from their default values for the benchmark measurements.

## **APPENDIX C: TESTED STORAGE CONFIGURATION (TSC) CREATION**

A CLI session is started with the NEC Storage M310, via one of the Host Systems, using telnet to enter the commands described below.

### **Telnet Login and Enter Maintenance Mode**

Start a telnet client on one of the Host System and specify the IP address of the NEC Storage M310 (*10.1.0.11 is the default value*).

Enter **sysadmin** as the username at the first prompt and **sys123** (*default value*) at the second prompt to logon to the NEC Storage M310.

The following command will place the NEC Storage M310 into maintenance mode:

```
iSMcfg setseize -mode on
```

### **Create Volume Group (Pools)**

The following commands will create 30 RAID-1 volume groups (pools), using 16 disk drives for each volume group:

```
iSMcfg poolbind -type dynamic -poolnumber 0000h -poolname Pool0000 -raid 1 -  
pdg 00h -pdn 0000h-000fh -time 0  
  
iSMcfg poolbind -type dynamic -poolnumber 0001h -poolname Pool0001 -raid 1 -  
pdg 00h -pdn 0010h-0017h,0100h-0107h -time 0  
  
iSMcfg poolbind -type dynamic -poolnumber 0002h -poolname Pool0002 -raid 1 -  
pdg 00h -pdn 0108h-0117h -time 0  
  
iSMcfg poolbind -type dynamic -poolnumber 0003h -poolname Pool0003 -raid 1 -  
pdg 00h -pdn 0200h-020fh -time 0  
  
iSMcfg poolbind -type dynamic -poolnumber 0004h -poolname Pool0004 -raid 1 -  
pdg 00h -pdn 0210h-0217h,0300h-0307h -time 0  
  
iSMcfg poolbind -type dynamic -poolnumber 0005h -poolname Pool0005 -raid 1 -  
pdg 00h -pdn 0308h-0317h -time 0  
  
iSMcfg poolbind -type dynamic -poolnumber 0006h -poolname Pool0006 -raid 1 -  
pdg 00h -pdn 0400h-040fh -time 0  
  
iSMcfg poolbind -type dynamic -poolnumber 0007h -poolname Pool0007 -raid 1 -  
pdg 00h -pdn 0410h-0417h,0500h-0507h -time 0  
  
iSMcfg poolbind -type dynamic -poolnumber 0008h -poolname Pool0008 -raid 1 -  
pdg 00h -pdn 0508h-0517h -time 0  
  
iSMcfg poolbind -type dynamic -poolnumber 0009h -poolname Pool0009 -raid 1 -  
pdg 00h -pdn 0600h-060fh -time 0  
  
iSMcfg poolbind -type dynamic -poolnumber 000ah -poolname Pool000a -raid 1 -  
pdg 00h -pdn 0610h-0617h,0700h-0707h -time 0  
  
iSMcfg poolbind -type dynamic -poolnumber 000bh -poolname Pool000b -raid 1 -  
pdg 00h -pdn 0708h-0717h -time 0  
  
iSMcfg poolbind -type dynamic -poolnumber 000ch -poolname Pool000c -raid 1 -  
pdg 00h -pdn 0800h-080fh -time 0
```

```
iSMcfg poolbind -type dynamic -poolnumber 000dh -poolname Pool000d -raid 1 -  
pdg 00h -pdn 0810h-0817h,0900h-0907h -time 0  
  
iSMcfg poolbind -type dynamic -poolnumber 000eh -poolname Pool000e -raid 1 -  
pdg 00h -pdn 0908h-0917h -time 0  
  
iSMcfg poolbind -type dynamic -poolnumber 000fh -poolname Pool000f -raid 1 -  
pdg 00h -pdn 1000h-100fh -time 0  
  
iSMcfg poolbind -type dynamic -poolnumber 0010h -poolname Pool0010 -raid 1 -  
pdg 00h -pdn 1010h-1017h,1100h-1107h -time 0  
  
iSMcfg poolbind -type dynamic -poolnumber 0011h -poolname Pool0011 -raid 1 -  
pdg 00h -pdn 1108h-1117h -time 0  
  
iSMcfg poolbind -type dynamic -poolnumber 0012h -poolname Pool0012 -raid 1 -  
pdg 00h -pdn 1200h-120fh -time 0  
  
iSMcfg poolbind -type dynamic -poolnumber 0013h -poolname Pool0013 -raid 1 -  
pdg 00h -pdn 1210h-1217h,1300h-1307h -time 0  
  
iSMcfg poolbind -type dynamic -poolnumber 0014h -poolname Pool0014 -raid 1 -  
pdg 00h -pdn 1308h-1317h -time 0  
  
iSMcfg poolbind -type dynamic -poolnumber 0015h -poolname Pool0015 -raid 1 -  
pdg 00h -pdn 1400h-140fh -time 0  
  
iSMcfg poolbind -type dynamic -poolnumber 0016h -poolname Pool0016 -raid 1 -  
pdg 00h -pdn 1410h-1417h,1500h-1507h -time 0  
  
iSMcfg poolbind -type dynamic -poolnumber 0017h -poolname Pool0017 -raid 1 -  
pdg 00h -pdn 1508h-1517h -time 0  
  
iSMcfg poolbind -type dynamic -poolnumber 0018h -poolname Pool0018 -raid 1 -  
pdg 00h -pdn 1600h-160fh -time 0  
  
iSMcfg poolbind -type dynamic -poolnumber 0019h -poolname Pool0019 -raid 1 -  
pdg 00h -pdn 1610h-1617h,1700h-1707h -time 0  
  
iSMcfg poolbind -type dynamic -poolnumber 001ah -poolname Pool001a -raid 1 -  
pdg 00h -pdn 1708h-1717h -time 0  
  
iSMcfg poolbind -type dynamic -poolnumber 001bh -poolname Pool001b -raid 1 -  
pdg 00h -pdn 1800h-180fh -time 0  
  
iSMcfg poolbind -type dynamic -poolnumber 001ch -poolname Pool001c -raid 1 -  
pdg 00h -pdn 1810h-1817h,1900h-1907h -time 0  
  
iSMcfg poolbind -type dynamic -poolnumber 001dh -poolname Pool001d -raid 1 -  
pdg 00h -pdn 1908h-1917h -time 0
```

## Create Logical Disks

The following commands will create 24 logical disks, one per volume group:

```
iSMcfg ldbind -poolnumber 0001h -ldn 0001h -capacity 2048 -unit gb -time 0
iSMcfg ldbind -poolnumber 0002h -ldn 0002h -capacity 2048 -unit gb -time 0
iSMcfg ldbind -poolnumber 0003h -ldn 0003h -capacity 2048 -unit gb -time 0
iSMcfg ldbind -poolnumber 0004h -ldn 0004h -capacity 2048 -unit gb -time 0
iSMcfg ldbind -poolnumber 0005h -ldn 0005h -capacity 2048 -unit gb -time 0
iSMcfg ldbind -poolnumber 0006h -ldn 0006h -capacity 2048 -unit gb -time 0
iSMcfg ldbind -poolnumber 0007h -ldn 0007h -capacity 2048 -unit gb -time 0
iSMcfg ldbind -poolnumber 0008h -ldn 0008h -capacity 2048 -unit gb -time 0
iSMcfg ldbind -poolnumber 0009h -ldn 0009h -capacity 2048 -unit gb -time 0
iSMcfg ldbind -poolnumber 000ah -ldn 000ah -capacity 2048 -unit gb -time 0
iSMcfg ldbind -poolnumber 000bh -ldn 000bh -capacity 2048 -unit gb -time 0
iSMcfg ldbind -poolnumber 000ch -ldn 000ch -capacity 2048 -unit gb -time 0
iSMcfg ldbind -poolnumber 000dh -ldn 000dh -capacity 2048 -unit gb -time 0
iSMcfg ldbind -poolnumber 000eh -ldn 000eh -capacity 2048 -unit gb -time 0
iSMcfg ldbind -poolnumber 000fh -ldn 000fh -capacity 2048 -unit gb -time 0
iSMcfg ldbind -poolnumber 0010h -ldn 0010h -capacity 2048 -unit gb -time 0
iSMcfg ldbind -poolnumber 0011h -ldn 0011h -capacity 2048 -unit gb -time 0
iSMcfg ldbind -poolnumber 0012h -ldn 0012h -capacity 2048 -unit gb -time 0
iSMcfg ldbind -poolnumber 0013h -ldn 0013h -capacity 2048 -unit gb -time 0
iSMcfg ldbind -poolnumber 0014h -ldn 0014h -capacity 2048 -unit gb -time 0
iSMcfg ldbind -poolnumber 0015h -ldn 0015h -capacity 2048 -unit gb -time 0
iSMcfg ldbind -poolnumber 0016h -ldn 0016h -capacity 2048 -unit gb -time 0
iSMcfg ldbind -poolnumber 0017h -ldn 0017h -capacity 2048 -unit gb -time 0
iSMcfg ldbind -poolnumber 0018h -ldn 0018h -capacity 2048 -unit gb -time 0
iSMcfg ldbind -poolnumber 0019h -ldn 0019h -capacity 2048 -unit gb -time 0
iSMcfg ldbind -poolnumber 001ah -ldn 001ah -capacity 2048 -unit gb -time 0
iSMcfg ldbind -poolnumber 001bh -ldn 001bh -capacity 2048 -unit gb -time 0
iSMcfg ldbind -poolnumber 001ch -ldn 001ch -capacity 2048 -unit gb -time 0
iSMcfg ldbind -poolnumber 001dh -ldn 001dh -capacity 2048 -unit gb -time 0
```

## Exit Maintenance Mode and Telnet Logoff

The following command will exit maintenance mode:

```
iSMcfg setseize -mode off -force
```

The telnet session is terminated with the **exit** command.

## SPC-1 Logical Volume Creation

The following steps are executed on a single Host System, using the Windows Disk Management utility, to create the SPC-1 Logical Volumes.

- a) Start the Windows Disk Management utility and confirm that the 30 logical disks are presented as 30 Windows “Disks”.
- b) Convert all 30 Windows “Disks” to Dynamic Disks.
- c) Create a Windows striped (RAID-0) volume for ASU-1 as follows:
  - i. Select 30 Windows “Disks”.
  - ii. Set the capacity of each stripe to 943,717 MB
  - iii. Assign drive letter “E” to the volume.
  - iv. Do not format the volume.
- d) Create a Windows striped (RAID-0) volume for ASU-2 as follows:
  - i. Select 30 Windows “Disks”.
  - ii. Set the capacity of each stripe to 943,717 MB
  - iii. Assign drive letter “F” to the volume.
  - iv. Do not format the volume.
- e) Create a Windows striped (RAID-0) volume for ASU-3 as follows:
  - i. Select 30 Windows “Disks”.
  - ii. Set the capacity of each stripe to 209,715 MB
  - iii. Assign drive letter “G” to the volume.
  - iv. Do not format the volume.
- f) Reboot all of the Host Systems.
- g) After the reboot completes, start the Windows Disk Management utility on each of the Host Systems.
- h) On each Host System, select either the import foreign disk or reactivate Windows stripe sets option, as necessary, then assign drive letters to the stripe sets as were defined in steps ‘c’ – ‘e’ above.

*Note: The values listed above as MB represent 1,048,576 bytes (MiB) per unit rather than 1,000,000 bytes.*

## **APPENDIX D: SPC-1 WORKLOAD GENERATOR STORAGE COMMANDS AND PARAMETERS**

### **ASU Pre-Fill**

```
compratio=1

sd=default,threads=8

sd=sd1,lun=\\.e:,size=29686769909760
sd=sd2,lun=\\.f:,size=29686769909760
sd=sd3,lun=\\.g:,size=6597063475200

wd=default,rdpct=0,seek=-1,xfersize=1048576
wd=wd1,sd=sd1
wd=wd2,sd=sd2
wd=wd3,sd=sd3
rd=PREPSSD,wd=wd*,iorate=max,elapsed=999990,interval=10
```

### **Primary Metrics and Repeatability Tests**

The content of SPC-1 Workload Generator command and parameter file used in this benchmark to execute the Primary Metrics (*Sustainability Test Phase, IOPS Test Phase, and Response Time Ramp Test Phase*) and Repeatability (*Repeatability Test Phase 1 and Repeatability Test Phase 2*) Tests is listed below.

```
* spc1_metrics.cfg

host=master
# 7slv x 4sv (ns61/62/63/64)
slaves=(ns61_1,ns61_2,ns61_3,ns61_4,ns61_5,ns61_6,ns61_7,ns62_1,ns62_2,ns62_3,ns62_4,ns62_5,ns62_6,ns62_7,ns63_1,ns63_2,ns63_3,ns63_4,ns63_5,ns63_6,ns63_7,ns64_1,ns64_2,ns64_3,ns64_4,ns64_5,ns64_6)

sd=asu1_1,lun=\\.e:,size=29686769909760
sd=asu2_1,lun=\\.f:,size=29686769909760
sd=asu3_1,lun=\\.g:,size=6597063475200
```

### **SPC-1 Persistence**

The content of SPC-1 Workload Generator command and parameter file, used in this benchmark to execute the SPC-1 Persistence Test, is listed below.

```
* spc1_persist.cfg

sd=asu1_1,lun=\\.e:,size=29686769909760
sd=asu2_1,lun=\\.f:,size=29686769909760
sd=asu3_1,lun=\\.g:,size=6597063475200
```

### **Slave JVMs**

The Slave JVM command and parameter files are documented in the [Slave JVMs](#) section of [Appendix E: SPC-1 Workload Generator Input Parameters](#).



## **APPENDIX E: SPC-1 WORKLOAD GENERATOR INPUT PARAMETERS**

There were 27 Slave JVMs used in the Primary Metrics and Repeatability Tests. Those Slave JVMs were started as the first step in the execution sequence. The [Slave JVMs](#) section below documents that step.

The following script, [master script 1 M310.bat](#), was executed to invoke the following in an uninterrupted execution sequence:

- Generate the first set of detailed storage configuration information required for a remote audit.
- The ASU pre-fill script, [prepsd.bat](#).
- The commands to execute the Primary Metrics Test (*Sustainability Test Phase, IOPS Test Phase, and Response Time Ramp Test Phase*), Repeatability Test (*Repeatability Test Phase 1 and Repeatability Test Phase 2*), and SPC-1 Persistence Test Run 1 (*write phase*).
- A script, [shutdown.bat](#), to power off the TSC.

The following script, [master script 2 M310.bat](#), was executed after the required TSC power off/power on cycle to execute the SPC-1 Persistence Test Run 2 (*read phase*) and generate the second set of detailed storage configuration information required for a remote audit.

### **Slave JVMs**

There were 27 Slave JVMs used in the Primary Metrics and Repeatability Tests. The script, [start\\_slave\\_7.bat](#), listed below, illustrates the commands to start the seven Slave JVMs (**ns61\_s1 – ns61\_s7**) that executed on the first Host System (**ns61**).

#### **start\_slave\_7.bat**

```
start java -Xmx1024m -Xms1024m spc1 -fns61_s1.parm -ons61_s1
start java -Xmx1024m -Xms1024m spc1 -fns61_s2.parm -ons61_s2
start java -Xmx1024m -Xms1024m spc1 -fns61_s3.parm -ons61_s3
start java -Xmx1024m -Xms1024m spc1 -fns61_s4.parm -ons61_s4
start java -Xmx1024m -Xms1024m spc1 -fns61_s5.parm -ons61_s5
start java -Xmx1024m -Xms1024m spc1 -fns61_s6.parm -ons61_s6
start java -Xmx1024m -Xms1024m spc1 -fns61_s7.parm -ons61_s7
```

The following scripts were used to start the remaining 20 Slave JVMs on the remaining three Host Systems (**ns62 – ns64**):

- **ns62: start\_slave\_7.bat**
- **ns63: start\_slave\_7.bat**
- **ns64: start\_slave\_6.bat**

The file, listed below, is the configuration file for the first Slave JVM (**ns61\_s1**).

### **ns61\_s1.parm**

```
host=ns61_1
master=192.168.10.161

sd=asu1_1,lun=\\.\e:
sd=asu2_1,lun=\\.\f:
sd=asu3_1,lun=\\.\g:
```

The following sets of configuration files were used for the remaining 20 Slave JVMs. The only difference in the remaining 26 configuration file is the **host=** parameter value, which specifies the appropriate Slave JVM (**ns61\_s2...ns63\_s6**).

- **ns61\_s2.parm – ns61\_s7.parm**
- **ns62\_s1.parm – ns62\_s7.parm**
- **ns63\_s1.parm – ns63\_s7.parm**
- **ns64\_s1.parm – ns63\_s6.parm**

### **master\_script\_M310.bat**

```
call profile.bat
call prepssd.bat

copy /y spc1_metrics.cfg spc1.cfg
java metrics -b 2640 -t 28800
java repeat1 -b 2640
java repeat2 -b 2640

copy /y spc1_persist.cfg spc1.cfg
java persist1 -b 2640

call shutdown.bat
```

### **ASU Pre-Fill**

The following script was invoked to execute the required ASU pre-fill using the command and parameter file documented in [Appendix D: SPC-1 Workload Generator Storage Commands and Parameters](#) on page [72](#).

### **prepssd.bat**

```
c:\spc\vdbench503rc11\vdbenchJRE32 -f c:\spc\prepssd.txt -o c:\spc\ssdprep
```

## TSC Power Off

The following script and command file were used to execute the required TSC power off after completion of SPC-1 Persistence Test Run 1.

### shutdown.bat

```
c:\spc\teraterm\ttermpro.exe /M=c:\spc\teraterm\M310_shutdown.ttl
```

### M310\_shutdown.ttl

```
;; connection user/password
HOSTADDR = '192.168.70.243'
USERNAME = 'sysadmin'
PASSWORD = 'sys123'
;=====
;; config
COMMAND = HOSTADDR
strconcat COMMAND ':23 /nossh /T=1'
;; connect
connect COMMAND
;; login
wait 'login: '
sendln USERNAME
wait 'Password: '
sendln PASSWORD

;; command1
wait 'sysadmin@2000201409020310-0# '
sendln 'iSMenv gettime'

;; command2
wait 'sysadmin@2000201409020310-0# '
sendln 'iSMview -all'

;; command3
wait 'sysadmin@2000201409020310-0# '
sendln 'iSMcfg shutdown -time 5'

;; finish
sendln 'exit'

end
```

### **SPC-1 Persistence Test Run 2 (*read phase*)**

The following script, was executed after the required TSC power off/power on cycle to execute the SPC-1 Persistence Test Run 2 (*read phase*) and generate the second set of detailed storage configuration information required for a remote audit.

#### **master\_script\_2\_M310.bat**

```
java persist2  
  
call profile.bat
```