



**SPC BENCHMARK 2C™
FULL DISCLOSURE REPORT**

**LSI CORPORATION
LSI MEGARAID SAS 8888ELP (24 DISKS)**

SPC-2C™ V1.1

**Submitted for Review: December 10, 2008
Submission Identifier: D00008**

First Edition - December 2008

THE INFORMATION CONTAINED IN THIS DOCUMENT IS DISTRIBUTED ON AN AS IS BASIS WITHOUT ANY WARRANTY EITHER EXPRESS OR IMPLIED. The use of this information or the implementation of any of these techniques is the customer's responsibility and depends on the customer's ability to evaluate and integrate them into the customer's operational environment. While each item has been reviewed by LSI Corporation for accuracy in a specific situation, there is no guarantee that the same or similar results will be obtained elsewhere. Customers attempting to adapt these techniques to their own environment do so at their own risk.

This publication was produced in the United States. LSI Corporation may not offer the products, services, or features discussed in this document in other countries, and the information is subject to change with notice. Consult your local LSI Corporation representative for information on products and services available in your area.

© Copyright LSI Corporation 2008. All rights reserved.

Permission is hereby granted to reproduce this document in whole or in part, provided the copyright notice as printed above is set forth in full text on the title page of each item reproduced.

Trademarks

SPC Benchmark 2C, SPC-2C, and SPC-2C MBPS are trademarks of the Storage Performance Council. LSI, the LSI logo, and MegaRAID are trademarks or registered trademarks of LSI Corporation in the United States and other countries. All other brands, trademarks, and product names are the property of their respective owners.

Table of Contents

Audit Certification	6
Audit Certification (cont.)	7
Letter of Good Faith	8
Executive Summary	9
Test Sponsor and Contact Information	9
Revision Information and Key Dates	9
Tested Storage Product (TSP) Description	9
SPC-2C Reported Data	10
Storage Capacities and Relationships	11
Tested Storage Configuration Pricing (Priced Storage Configuration)	12
Differences between the Tested Storage Configuration (TSC) and Priced Storage Configuration	12
Benchmark Configuration/Tested Storage Configuration Diagram	13
Host System(s) and Tested Storage Configuration Components	13
Configuration Information	14
Benchmark Configuration (BC)/Tested Storage Configuration (TSC) Diagram	14
Host System and Tested Storage Configuration Table	14
Customer Tunable Parameters and Options	15
Tested Storage Configuration (TSC) Creation and Configuration	15
SPC-2C Workload Generator Storage Configuration	15
SPC-2C Data Repository	16
SPC-2C Storage Capacities and Relationships	16
SPC-2C Storage Capacities	16
SPC-2C Storage Hierarchy Ratios	17
SPC-2C Storage Capacities and Relationships Illustration	17
Logical Volume Capacity and ASU Mapping	18
SPC-2C Test Execution Results	19
SPC-2C Tests, Test Phases, Test Run Sequences, and Test Runs	19
Large File Processing Test	22
SPC-2C Workload Generator Commands and Parameters	22
SPC-2C Test Results File	23
SPC-2C Large File Processing Average Data Rates (MB/s)	23
SPC-2C Large File Processing Average Data Rates Graph.....	24
SPC-2C Large File Processing Average Data Rate per Stream	25
SPC-2C Large File Processing Average Data Rate per Stream Graph.....	26

SPC-2C Large File Processing Average Response Time	27
SPC-2C Large File Processing Average Response Time Graph	28
Large File Processing Test – WRITE ONLY Test Phase	29
Large File Processing Test – READ-WRITE Test Phase	30
Large File Processing Test – READ ONLY Test Phase	31
Large Database Query Test.....	32
SPC-2C Workload Generator Commands and Parameters	33
SPC-2C Test Results File	33
SPC-2C Large Database Query Average Data Rates (MB/s).....	34
SPC-2C Large Database Query Average Data Rates Graph	34
SPC-2C Large Database Query Average Data Rate per Stream.....	35
SPC-2C Large Database Query Average Data Rate per Stream Graph.....	35
SPC-2C Large Database Query Average Response Time	36
SPC-2C Large Database Query Average Response Time Graph.....	36
Large Database Query Test – 1024 KiB TRANSFER SIZE Test Phase	37
Large Database Query Test – 64 KiB TRANSFER SIZE Test Phase	38
Video on Demand Delivery Test	39
SPC-2C Workload Generator Commands and Parameters	39
SPC-2C Test Results File	40
SPC-2C Video on Demand Delivery Test Run Data.....	40
Video on Demand Delivery Test – TEST RUN DATA BY INTERVAL.....	41
SPC-2C Video on Demand Delivery Average Data Rate Graph.....	42
SPC-2C Video on Demand Delivery Average Data Rate per Stream Graph	42
SPC-2C Video on Demand Delivery Average Response Time Graph.....	43
SPC-2C Video on Demand Delivery Maximum Response Time Graph	43
Data Persistence Test.....	44
SPC-2C Workload Generator Commands and Parameters	44
Data Persistence Test Results File	44
Data Persistence Test Results.....	45
Priced Storage Configuration Availability Date.....	46
Anomalies or Irregularities	46
Appendix A: SPC-2C Glossary	47
“Decimal” (<i>powers of ten</i>) Measurement Units.....	47
“Binary” (<i>powers of two</i>) Measurement Units.....	47
SPC-2C Data Repository Definitions	47
SPC-2C Data Protection Levels.....	48
SPC-2C Test Execution Definitions.....	48
I/O Completion Types.....	51

SPC-2C Test Run Components	51
Appendix B: Customer Tunable Parameters and Options.....	52
Disk Enclosure Backplane Configuration.....	52
Appendix C: Tested Storage Configuration (TSC) Creation	54
Create RAID-5 Volumes	54
Clear RAID volumes	54
Get disk list	54
Create the RAID-5 Volumes	54
Configure SPC-2C Application Storage Unit (ASU)	55
Disable Volume Initialization.....	55
Appendix D: SPC-2C Workload Generator Storage Commands and Parameters	56
Large File Processing Test (LFP)	56
Large Database Query Test (LDQ)	57
Video on Demand Delivery Test (VOD).....	58
Persistence Test Run 1 (write phase)	58
Persistence Test Run 2 (read phase)	59
Appendix E: SPC-2C Workload Generator Execution Commands and Parameters	60
Video on Demand Delivery, Large File Processing Test, Large Database Query Tests, and Persistence Test Run 1	60
Persistence Test Run 2.....	60
Appendix F: Third-Party Quotes	62
LSI MegaRAID SAS 8888ELP	62
Seagate Savvio™ 15K, 36 GB SAS Disk Drives	63
AIC XJ SA26-224R Disk Enclosure	63
AIC XJ SA26-224R Disk Enclosure	64
External SAS Cables	65

AUDIT CERTIFICATION



Charles Gimarc
LSI Corporation
4420 ArrowsWest Dr.
Colorado Springs, CO 80907

December 8, 2008

The SPC Benchmark 2C™ results listed below for the LSI MegaRAID SAS 8888ELP (24 disks) were produced in compliance with the SPC Benchmark 2C™ V1.1 Audit requirements.

SPC Benchmark 2C™ V1.1 Results	
Tested Storage Product: LSI MegaRAID SAS 8888ELP (24 disks)	
Metric	Reported Result
SPC-2C MBPS™	683.66
ASU Capacity	293.626
Data Protection Level	Protected (RAID-5)
Total Price – Priced Storage Configuration	\$9,597.13

The following SPC Benchmark 2C™ Audit requirements were reviewed and found compliant with V1.1 of the SPC Benchmark 2C™ specification:

- A Letter of Good Faith, signed by a senior executive.
- The following Data Repository storage items were verified by physical inspection and documentation supplied by LSI Corporation:
 - ✓ Physical Storage Capacity and related requirements.
 - ✓ Configured Storage Capacity and related requirements.
 - ✓ Addressable Storage Capacity and related requirements.
 - ✓ Capacity of each Logical Volume and related requirements.
 - ✓ Capacity of the Application Storage Unit (ASU) and related requirements.
- An appropriate diagram of the Benchmark Configuration (BC)/Tested Storage Configuration (TSC).
- Physical verification of the components to match the above diagram.
- Listings and commands used to create and configure the Benchmark Configuration/Tested Storage Configuration.

Storage Performance Council
643 Bair Island Road, Suite 103
Redwood City, CA 94062
AuditService@StoragePerformance.org
650.556.9384

AUDIT CERTIFICATION (CONT.)

LSI MegaRAID SAS 8888ELP (24 disks)
SPC-2C Audit Certification

Page 2

- Documentation of each customer tunable parameter or option that was changed from its default value.
- The following Host System items were verified by physical inspection and documentation supplied by LSI Corporation:
 - ✓ Required Host System configuration information.
 - ✓ The TSC boundary within each Host System.
- The following SPC-2C Workload Generator information was verified by physical inspection and documentation supplied by LSI Corporation:
 - ✓ The presence and version number of the SPC-2C Workload Generator on each Host System.
 - ✓ Commands and parameters used to configure the SPC-2C Workload Generator.
- The Test Results Files and resultant Summary Results Files received for each of the following were authentic, accurate, and compliant with all of the requirements and constraints of Clauses 5 and 6 of the SPC-2C Benchmark Specification:
 - ✓ Data Persistence Test
 - ✓ Large File Processing Test
 - ✓ Large Database Query Test
 - ✓ Video on Demand Delivery Test
- There were no differences between the Tested Storage Configuration (TSC) used for the benchmark and the Priced Storage Configuration.
- The submitted pricing information met all of the requirements and constraints of Clause 9 of the SPC-2C Benchmark Specification.
- The Full Disclosure Report (FDR) met all of the requirements in Clause 10 of the SPC-2C Benchmark Specification.
- This successfully audited SPC measurement is not subject to an SPC Confidential Review.

Audit Notes:

There were no audit notes or exceptions.

Respectfully,

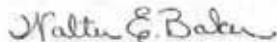

Walter E. Baker
SPC Auditor

Storage Performance Council
843 Bair Island Road, Suite 103
Redwood City, CA 94062
AuditService@StoragePerformance.org
650.556.9384

LETTER OF GOOD FAITH

LSI Corporation
1521 Barber Lane
Milpitas, CA 95035

1 800 372 2447
lsi.com



Date: *October 28, 2008*
From: *Kelly Bryant*
To: *Walter Baker*
Subject: *SPC-2C Letter of Good Faith for the LSI MegaRAID SAS 8888ELP (24 Disk)*

LSI Corporation is the SPC-2C Test Sponsor of the above listed product. To the best of our knowledge and belief, the required SPC-2C benchmark results and materials we have submitted for that product are complete, accurate, and in full compliance with V1.1 of the SPC-2C benchmark specification.

In addition, we have reported any items in the Benchmark Configuration and execution of the benchmark necessary to reproduce the reported results even if the items are not explicitly required to be disclosed by the above SPC-2C benchmark specification.

Signed

A handwritten signature in blue ink, appearing to read "Kelly Bryant", written over a horizontal line.

Kelly Bryant
Director, Direct Attached Storage
Engenio Storage Group

10/12/08

Date

LSI Corporation
4165 Shackleford Road
Norcross
GA 30093

EXECUTIVE SUMMARY

Test Sponsor and Contact Information

Test Sponsor and Contact Information	
Test Sponsor Primary Contact	LSI Corporation – http://www.lsi.com Charles Gimarc – charles.gimarc@lsi.com 4420 ArrowsWest Dr. Colorado Spring, CO 80907 Phone: (719) 533-7427 FAX: (719) 533-7183
Test Sponsor Alternate Contact	LSI Corporation – http://www.lsi.com Mark Regester – mark.regester@lsi.com 3718 N. Rock Road Wichita, KS 67226 Phone: (316) 636-8340 FAX: (316) 636-8554
Auditor	Storage Performance Council – http://www.storageperformance.org Walter E. Baker – AuditService@StoragePerformance.org 643 Bair Island Road, Suite 103 Redwood City, CA 94063 Phone: (650) 556-9384 FAX: (650) 556-9385

Revision Information and Key Dates

Revision Information and Key Dates	
SPC-2C Specification revision number	V1.1
SPC-2C Workload Generator revision number	V1.0
Date Results were first used publicly	December 10, 2008
Date FDR was submitted to the SPC	December 10, 2008
Date the TSC will be available for shipment to customers	currently available
Date the TSC completed audit certification	December 8, 2008

Tested Storage Product (TSP) Description

The MegaRAID SAS 8888ELP, a second generation SAS RAID product, addresses the business demands of data availability, data protection, and performance. The adapter features the LSI SAS 1078, an I/O storage engine that performs data protection, data checking, and data restoration. The adapter employs selectable connectors, enabling it to serve three deployment scenarios: two internal, two external, or one of each. Up to 240 disks can be attached, all SAS, all SATA, or a combination of both. A RAID data cache of 512 MB is available with two battery backup options. The adapter uses a 500 MHz Power PC embedded processor, 667 MHz data cache, 8 lanes of PCI express, and eight 3 Gb/s SAS links to provide class-leading I/O performance. RAID levels 0, 1, 5, and 6 are configurable, as are RAID spans 10, 50, and 60.

SPC-2C Reported Data

SPC-2C Reported Data consists of three groups of information:

- The following SPC-2C Primary Metrics, which characterize the overall benchmark result:
 - SPC-2C MBPS™
 - Application Storage Unit (ASU) Capacity
- Supplemental data to the SPC-2C Primary Metrics.
 - Total Price
 - Data Protection Level
- Reported Data for each SPC Test: Large File Processing (LFP), Large Database Query (LDQ), and Video on Demand Delivery (VOD) Test.

SPC-2C Reported Data			
LSI MegaRAID 8888ELP (24 disks)			
SPC-2C MBPS™	ASU Capacity(GB)	Total Price	Data Protection Level
683.66	293.626	\$9,597.13	Protected (RAID-5)
<i>The above SPC-2C MBPS™ value represents the aggregate data rate of all three SPC-2C workloads: Large File Processing, Large Database Query, and Video On Demand</i>			
SPC-2 Large File Processing (LFP) Reported Data			
	Data Rate (MB/second)	Number of Streams	Data Rate per Stream
LFP Composite	653.99		
Write Only:			
1024 KiB Transfer	461.76	10	46.18
256 KiB Transfer	451.70	10	45.17
Read-Write:			
1024 KiB Transfer	705.48	10	70.55
256 KiB Transfer	538.59	10	53.86
Read Only:			
1024 KiB Transfer	771.73	10	77.17
256 KiB Transfer	994.68	10	99.47
<i>The above SPC-2C Data Rate value for LFP Composite represents the aggregate performance of all three LFP Test Phases: (Write Only, Read-Write, and Read Only).</i>			
SPC-2 Large Database Query (LDQ) Reported Data			
	Data Rate (MB/second)	Number of Streams	Data Rate per Stream
LDQ Composite	877.95		
1024 KiB Transfer Size			
4 I/Os Outstanding	1,308.79	10	130.88
1 I/O Outstanding	771.92	10	77.19
64 KiB Transfer Size			
4 I/Os Outstanding	873.41	10	87.34
1 I/O Outstanding	557.69	10	55.77
<i>The above SPC-2C Data Rate value for LDQ Composite represents the aggregate performance of the two LDQ Test Phases: (1024 KiB and 64 KiB Transfer Sizes).</i>			
SPC-2 Video On Demand (VOD) Reported Data			
	Data Rate (MB/second)	Number of Streams	Data Rate per Stream
	519.05	660	0.79

SPC-2C MBPS™ represents the aggregate data rate, in megabytes per second, of all three SPC-2C workloads: Large File Processing (LFP), Large Database Query (LDQ), and Video on Demand (VOD).

ASU (Application Storage Unit) Capacity represents the total storage capacity read and written in the course of executing the SPC-2C benchmark.

A **Data Protection Level of Protected (RAID-5)** provides data protection by distributing check data corresponding to user data across multiple disks in the form of bit-by-bit parity.

Storage Capacities and Relationships

The Tested Storage Configuration (TSC) must be configured so that there is either no Unused Storage or that the sum of Total ASU Capacity plus storage required for data protection equals 50% (+1 GiB) of the Physical Storage Capacity. This configuration meets the 50% requirement as documented below:

$$550.559 \text{ GB (Physical Storage Capacity)} * 0.5 = 275.280 \text{ GB}$$

$$183.517 \text{ GB (Total ASU Capacity)} + 91.758 \text{ GB (data protection)} = 275.275 \text{ GB}$$

The following diagram (*not to scale*) documents the various storage capacities and their relationships, used in this SPC-2C benchmark measurement.

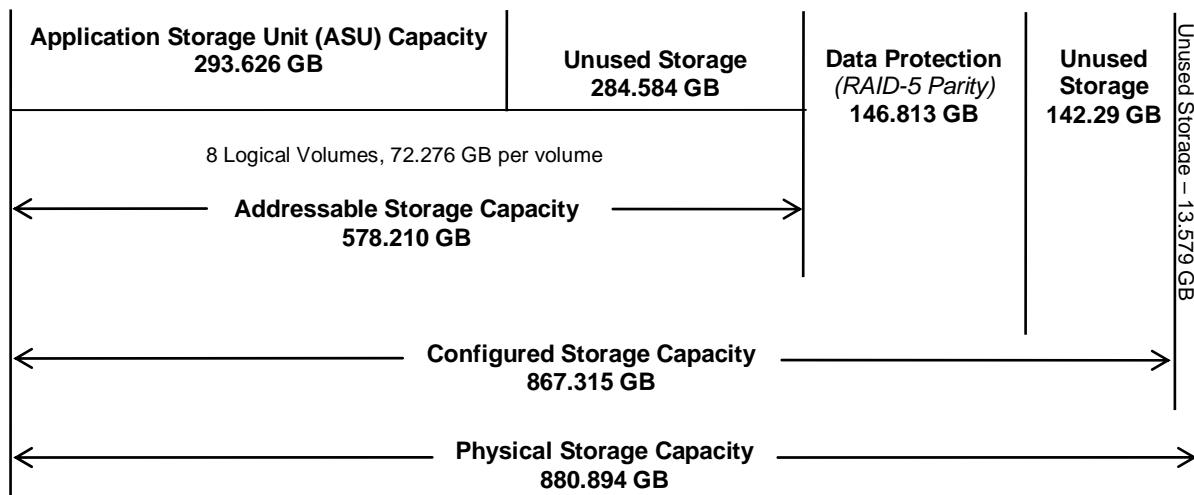

Tested Storage Configuration Pricing (*Priced Storage Configuration*)

Component Description	Part Number	Qty	Price	Extd Price
MegaRAID Adapter	SAS 8888ELP	1	789.99	789.99
AIC 24-disk Enclosure	XJ-SA26-224R	1	2,087.14	2,087.14
Seagate Savvio 15K.1 disk	ST936751SS	24	276.00	6,624.00
External mini SAS Cable	SA-8888-1m	2	48.00	96.00
			Total Cost	9,597.13

Differences between the Tested Storage Configuration (TSC) and Priced Storage Configuration

There were no differences between the Tested Storage Configuration and the Priced Storage Configuration.

Benchmark Configuration/Tested Storage Configuration Diagram

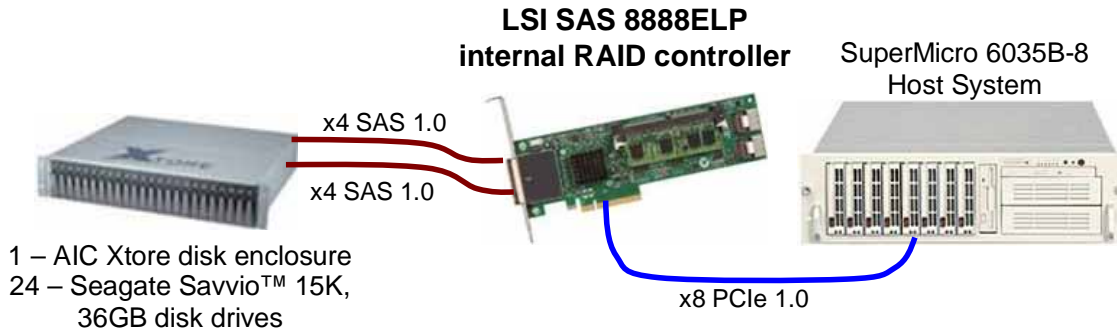

Host System(s) and Tested Storage Configuration Components

Host System:	Tested Storage Configuration (TSC):
SuperMicro 6035B-8 2 – 2.66 GHz Intel Xeon x5355 processors 32+32 KB L1 cache per core 4 MB L2 cache per die	1 – LSI MegaRAID SAS 8888ELP internal RAID controller with: 512 MB cache 1 - x8 PCIe 1.0 host connect 2 - x8 3 Gb/s SAS 1.0 disk connect
8 GB main memory	
Windows 2003 Enterprise Edition	1 – AIC Xtore XJ-SA260224R-s disk enclosure
PCIe 1.0	24 – Seagate Savvio™ 15K, 36 GB SAS disks
	2 – x4 external SAS cables

CONFIGURATION INFORMATION

This portion of the Full Disclosure Report documents and illustrates the detailed information necessary to recreate the Benchmark Configuration (BC), including the Tested Storage Configuration (TSC), so that the SPC-2C benchmark result produced by the BC may be independently reproduced.

In each of the following sections of this document, the appropriate Full Disclosure Report requirement, from the SPC-2C benchmark specification, is stated in italics followed by the information to fulfill the stated requirement.

Benchmark Configuration (BC)/Tested Storage Configuration (TSC) Diagram

Clause 10.4.5.9

The Executive Summary will contain a one page BC/TSC diagram that illustrates all major components of the BC/TSC.

The Benchmark Configuration (BC)/Tested Storage Configuration (TSC) is illustrated on page 13 (*Benchmark Configuration/Tested Storage Configuration Diagram*).

Host System and Tested Storage Configuration Table

Clause 10.4.5.10

The Executive Summary will contain a table that lists the major components of each Host System and the Tested Storage Configuration.

The components that comprise each Host System and the Tested Storage Configuration are listed in the table that appears on page 13 (*Host System(s) and Tested Storage Configuration Components*).

Customer Tunable Parameters and Options

Clause 10.4.6.1

All Benchmark Configuration (BC) components with customer tunable parameter and options that have been altered from their default values must be listed in the FDR. The FDR entry for each of those components must include both the name of the component and the altered value of the parameter or option. If the parameter name is not self-explanatory to a knowledgeable practitioner, a brief description of the parameter's use must also be included in the FDR entry.

“Appendix B: Customer Tunable Parameters and Options” on page 52 contains the customer tunable parameters and options that have been altered from their default values for this benchmark.

Tested Storage Configuration (TSC) Creation and Configuration

Clause 10.4.6.2

The Full Disclosure Report must include sufficient information to recreate the logical representation of the Tested Storage Configuration (TSC). In addition to customer tunable parameters and options (Clause 10.6.6.1), that information must include, at a minimum:

- *A diagram and/or description of the following:*
 - *All physical components that comprise the TSC. Those components are also illustrated in the BC Configuration Diagram in Clause 10.6.5.7 and the Storage Network Configuration Diagram in Clause 10.4.5.9.*
 - *The logical representation of the TSC, configured from the above components that will be presented to the SPC-2C Workload Generator.*
- *Listings of scripts used to create the logical representation of the TSC.*
- *If scripts were not used, a description of the process used with sufficient detail to recreate the logical representation of the TSC.*

“Appendix C: Tested Storage Configuration (TSC) Creation” on page 54 contains the detailed information that describes how to create and configure the logical TSC.

SPC-2C Workload Generator Storage Configuration

Clause 10.4.6.3

The Full Disclosure Report will include all SPC-2C Workload Generator storage configuration commands and parameters used in the SPC-2C benchmark measurement.

The SPC-2C Workload Generator storage configuration commands and parameters for this measurement appear in “Appendix D: SPC-2C Workload Generator Storage Commands and Parameters” on page 54.

SPC-2C DATA REPOSITORY

This portion of the Full Disclosure Report presents the detailed information that fully documents the various SPC-2C storage capacities and mappings used in the Tested Storage Configuration. “SPC-2C Data Repository Definitions” on page 47 contains definitions of terms specific to the SPC-2C Data Repository.

In each of the following sections of this document, the appropriate Full Disclosure Report requirement, from the SPC-2C benchmark specification, is stated in italics followed by the information to fulfill the stated requirement.

SPC-2C Storage Capacities and Relationships

Clause 10.4.7.1

Two tables and an illustration documenting the storage capacities and relationships of the SPC-2C Storage Hierarchy (Clause 2.1) shall be included in the FDR.

SPC-2C Storage Capacities

SPC-2C Storage Capacities		
Storage Hierarchy Component	Units	Capacity
Total ASU Capacity	Gigabytes (GB)	293.626
Addressable Storage Capacity	Gigabytes (GB)	578.210
Configured Storage Capacity	Gigabytes (GB)	867.315
Physical Storage Capacity	Gigabytes (GB)	880.894
Data Protection (<i>Protected, RAID-5</i>)	Gigabytes (GB)	146.813
Required Storage	Gigabytes (GB)	0.000
Global Storage Overhead	Gigabytes (GB)	0.000
Total Unused Storage	Gigabytes (GB)	440.455

SPC-2C Storage Hierarchy Ratios

	Addressable Storage Capacity	Configured Storage Capacity	Physical Storage Capacity
Total ASU Capacity	50.78%	33.85%	33.33%
Data Protection (<i>Protected, RAID-5</i>)		16.93%	16.67%
Addressable Storage Capacity		66.67%	65.64%
Required Storage		0.00%	0.00%
Configured Storage Capacity			98.46%
Global Storage Overhead			0.00%
Unused Storage:			
Addressable	49.22%		
Configured		16.41%	
Physical			1.54%

The Physical Storage Capacity consisted of 880.894 GB distributed over 24 disk drives each with a formatted capacity of 36.704 GB. There was 13.579 GB (1.54%) of Unused Storage within the Physical Storage Capacity. Global Storage Overhead consisted of 0.000 GB (0.00%) of Physical Storage Capacity. There was 142.292 GB (16.41%) of Unused Storage within the Configured Storage Capacity. The Total ASU Capacity utilized 50.78% of the Addressable Storage Capacity resulting in 284.584 GB (49.22%) of Unused Storage within the Addressable Storage Capacity.

SPC-2C Storage Capacities and Relationships Illustration

The various storage capacities configured in the benchmark result are illustrated below (not to scale).

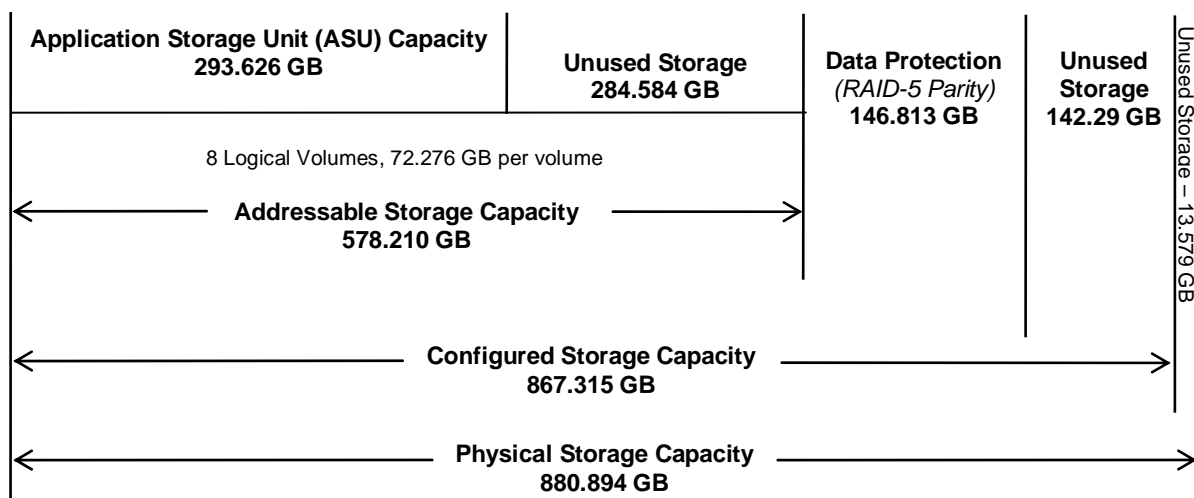

Logical Volume Capacity and ASU Mapping

Clause 10.4.7.2

A table illustrating the capacity of the Application Storage Unit (ASU) and the mapping of Logical Volumes to ASU will be provided in the FDR. Capacity must be stated in gigabytes (GB) as a value with a minimum of two digits to the right of the decimal point. Each Logical Volume will be sequenced in the table from top to bottom per its position in the contiguous address space of the ASU. Each Logical Volume entry will list its total capacity, the portion of that capacity used for the ASU, and any unused capacity.

Logical Volume (LV) Capacity and Mapping			
ASU (293.626 GB)			
	Total Capacity (GB)	Capacity Used (GB)	Capacity Unused (GB)
Logical Volumes 1-8	72.276 per LV	36.703 per LV	36.573 per LV

See the Storage Definition (sd) entries in “Appendix D: SPC-2C Workload Generator Storage Commands and Parameters” on page 54 for more detailed configuration information.

SPC-2C TEST EXECUTION RESULTS

This portion of the Full Disclosure Report documents the results of the various SPC-2C Test, Test Phases, Test Run Sequences, and Test Runs. “SPC-2C Test Execution Definitions” on page 48 contains definitions of terms specific to the SPC-2C Data Repository.

In each of the following sections of this document, the appropriate Full Disclosure Report requirement, from the SPC-2C benchmark specification, is stated in italics followed by the information to fulfill the stated requirement.

SPC-2C Tests, Test Phases, Test Run Sequences, and Test Runs

The SPC-2C benchmark consists of the following Tests, Test Phases, Test Run Sequences, and Test Runs:

- **Large File Processing Test**
 - **WRITE ONLY Test Phase**
 - **Test Run Sequence 1**
 - ✓ Test Run 1 – 1024 KiB Transfer – maximum number of Streams
 - ✓ Test Run 2 – 1024 KiB Transfer – 50% of Test Run 1’s Streams value
 - ✓ Test Run 3 – 1024 KiB Transfer – 25% of Test Run 1’s Streams value
 - ✓ Test Run 4 – 1024 KiB Transfer – 12.5% of Test Run 1’s Streams value
 - ✓ Test Run 5 – 1024 KiB Transfer – single (1) Stream
 - **Test Run Sequence 2**
 - ✓ Test Run 6 – 256 KiB Transfer – maximum number of Streams
 - ✓ Test Run 7 – 256 KiB Transfer – 50% of Test Run 6’s Streams value
 - ✓ Test Run 8 – 256 KiB Transfer – 25% of Test Run 6’s Streams value
 - ✓ Test Run 9 – 256 KiB Transfer – 12.5% of Test Run 6’s Streams value
 - ✓ Test Run 10 – 256 KiB Transfer – single (1) Stream
 - **READ-WRITE Test Phase**
 - **Test Run Sequence 3**
 - ✓ Test Run 11 – 1024 KiB Transfer – maximum number of Streams
 - ✓ Test Run 12 – 1024 KiB Transfer – 50% of Test Run 11’s Streams value
 - ✓ Test Run 13 – 1024 KiB Transfer – 25% of Test Run 11’s Streams value
 - ✓ Test Run 14 – 1024 KiB Transfer – 12.5% of Test Run 11’s Streams value
 - ✓ Test Run 15 – 1024 KiB Transfer – single (1) Stream
 - **Test Run Sequence 4**
 - ✓ Test Run 16 – 256 KiB Transfer – maximum number of Streams
 - ✓ Test Run 17 – 256 KiB Transfer – 50% of Test Run 16’s Streams value
 - ✓ Test Run 18 – 256 KiB Transfer – 25% of Test Run 16’s Streams value
 - ✓ Test Run 19 – 256 KiB Transfer – 12.5% of Test Run 16’s Streams value
 - ✓ Test Run 20 – 256 KiB Transfer – single (1) Stream

- **Large File Processing Test (continued)**
 - READ ONLY Test Phase
 - Test Run Sequence 5
 - ✓ Test Run 21 – 1024 KiB Transfer – maximum number of Streams
 - ✓ Test Run 22 – 1024 KiB Transfer – 50% of Test Run 21's Streams value
 - ✓ Test Run 23 – 1024 KiB Transfer – 25% of Test Run 21's Streams value
 - ✓ Test Run 24 – 1024 KiB Transfer – 12.5% of Test Run 21's Streams value
 - ✓ Test Run 25 – 1024 KiB Transfer – single (1) Stream
 - Test Run Sequence 6
 - ✓ Test Run 26 – 256 KiB Transfer – maximum number of Streams
 - ✓ Test Run 27 – 256 KiB Transfer – 50% of Test Run 26's Streams value
 - ✓ Test Run 28 – 256 KiB Transfer – 25% of Test Run 26's Streams value
 - ✓ Test Run 29 – 256 KiB Transfer – 12.5% of Test Run 26's Streams value
 - ✓ Test Run 30 – 256 KiB Transfer – single (1) Stream
- **Large Database Query Test**
 - 1024 KiB TRANSFER SIZE Test Phase
 - Test Run Sequence 1
 - ✓ Test Run 1 – 4 I/O Requests Outstanding – maximum number of Streams
 - ✓ Test Run 2 – 4 I/O Requests Outstanding – 50% of Test Run 1's Streams value
 - ✓ Test Run 3 – 4 I/O Requests Outstanding – 25% of Test Run 1's Streams value
 - ✓ Test Run 4 – 4 I/O Requests Outstanding – 12.5% of Test Run 1's Streams value
 - ✓ Test Run 5 – 4 I/O Requests Outstanding – single (1) Stream
 - Test Run Sequence 2
 - ✓ Test Run 6 – 1 I/O Request Outstanding – maximum number of Streams
 - ✓ Test Run 7 – 1 I/O Request Outstanding – 50% of Test Run 6's Streams value
 - ✓ Test Run 8 – 1 I/O Request Outstanding – 25% of Test Run 6's Streams value
 - ✓ Test Run 9 – 1 I/O Request Outstanding – 12.5% of Test Run 6's Streams value
 - ✓ Test Run 10 – 1 I/O Request Outstanding – single (1) Stream
 - 64 KiB TRANSFER SIZE Test Phase
 - Test Run Sequence 3
 - ✓ Test Run 11 – 4 I/O Requests Outstanding – maximum number of Streams
 - ✓ Test Run 12 – 4 I/O Requests Outstanding – 50% of Test Run 11's Streams value
 - ✓ Test Run 13 – 4 I/O Requests Outstanding – 25% of Test Run 11's Streams value
 - ✓ Test Run 14 – 4 I/O Requests Outstanding – 12.5% of Test Run 11's Streams value
 - ✓ Test Run 15 – 4 I/O Requests Outstanding – single (1) Stream
 - Test Run Sequence 4
 - ✓ Test Run 16 – 1 I/O Request Outstanding – maximum number of Streams
 - ✓ Test Run 17 – 1 I/O Request Outstanding – 50% of Test Run 16's Streams value
 - ✓ Test Run 18 – 1 I/O Request Outstanding – 25% of Test Run 16's Streams value
 - ✓ Test Run 19 – 1 I/O Request Outstanding – 12.5% of Test Run 16's Streams value
 - ✓ Test Run 20 – 1 I/O Request Outstanding – single (1) Stream
- **Video on Demand Delivery Test**
 - Video on Demand Delivery Test Run
- **Data Persistence Test**
 - Data Persistence Test Run 1
 - Data Persistence Test Run 2

Each Test is an atomic unit that must be executed from start to finish before any other Test, Test Phase, or Test Run may be executed.

The results from each Test, Test Phase, and Test Run are listed below along with a more detailed explanation of each component.

Large File Processing Test

Clause 6.4.3.1

The Large File Processing Test consists of the I/O operations associated with the type of applications, in a wide range of fields, which require simple sequential processing of one or more large files. Specific examples of those types of applications include scientific computing and large-scale financial processing

Clause 6.4.3.2

The Large File Processing Test has three Test Phases, which shall be executed in the following uninterrupted sequence:

1. *WRITE ONLY*
2. *READ-WRITE*
3. *READ ONLY*

The BC shall not be restarted or manually disturbed, altered, or adjusted during the execution of the Large File Processing Test. If power is lost to the BC during this Test all results shall be rendered invalid and the Test re-run in its entirety.

Clause 10.4.8.1

The Full Disclosure Report will contain the following content for the Large File Processing Test:

1. *A listing of the SPC-2C Workload Generator commands and parameters used to execute each of the Test Runs in the Large File Processing Test.*
2. *The human readable SPC-2C Test Results File for each of the Test Runs in the Large File Processing Test.*
3. *A table that contains the following information for each Test Run in all three Test Phases of the Large File Processing Test:*
 - *The number Streams specified.*
 - *The Ramp-Up duration in seconds.*
 - *The Measurement Interval duration in seconds.*
 - *The average data rate, in MB per second, for the Measurement Interval.*
 - *The average data rate, in MB per second, per Stream for the Measurement Interval.*
4. *Average Data Rate and Average Data Rate per Stream graphs as defined in Clauses 10.1.1 and 10.1.2.*

SPC-2C Workload Generator Commands and Parameters

The SPC-2C Workload Generator commands and parameters for the Large File Processing Test Runs are documented in “Appendix E: SPC-2C Workload Generator Execution Commands and Parameters” on Page 60.

SPC-2C Test Results File

A link to the SPC-2C Test Results file generated from the Large File Processing Test Runs is listed below.

[SPC-2C Large File Processing Test Results File](#)

SPC-2C Large File Processing Average Data Rates (MB/s)

The average Data Rate (MB/s) for each Test Run in the three Test Phases of the SPC-2C Large File Processing Test is listed in the table below as well as illustrated in the following graph.

Test Run Sequence	1 Stream	2 Streams	3 Streams	5 Streams	10 Streams
Write 1024KiB	258.45	427.11	434.76	453.67	461.76
Write 256KiB	258.42	399.93	424.25	440.34	451.70
Read/Write 1024KiB	181.04	342.38	444.28	592.69	705.48
Read/Write 256KiB	312.39	530.26	462.39	501.74	538.59
Read 1024KiB	138.41	277.28	396.69	561.10	771.73
Read 256KiB	198.97	398.37	507.40	727.03	994.68

SPC-2C Large File Processing Average Data Rates Graph

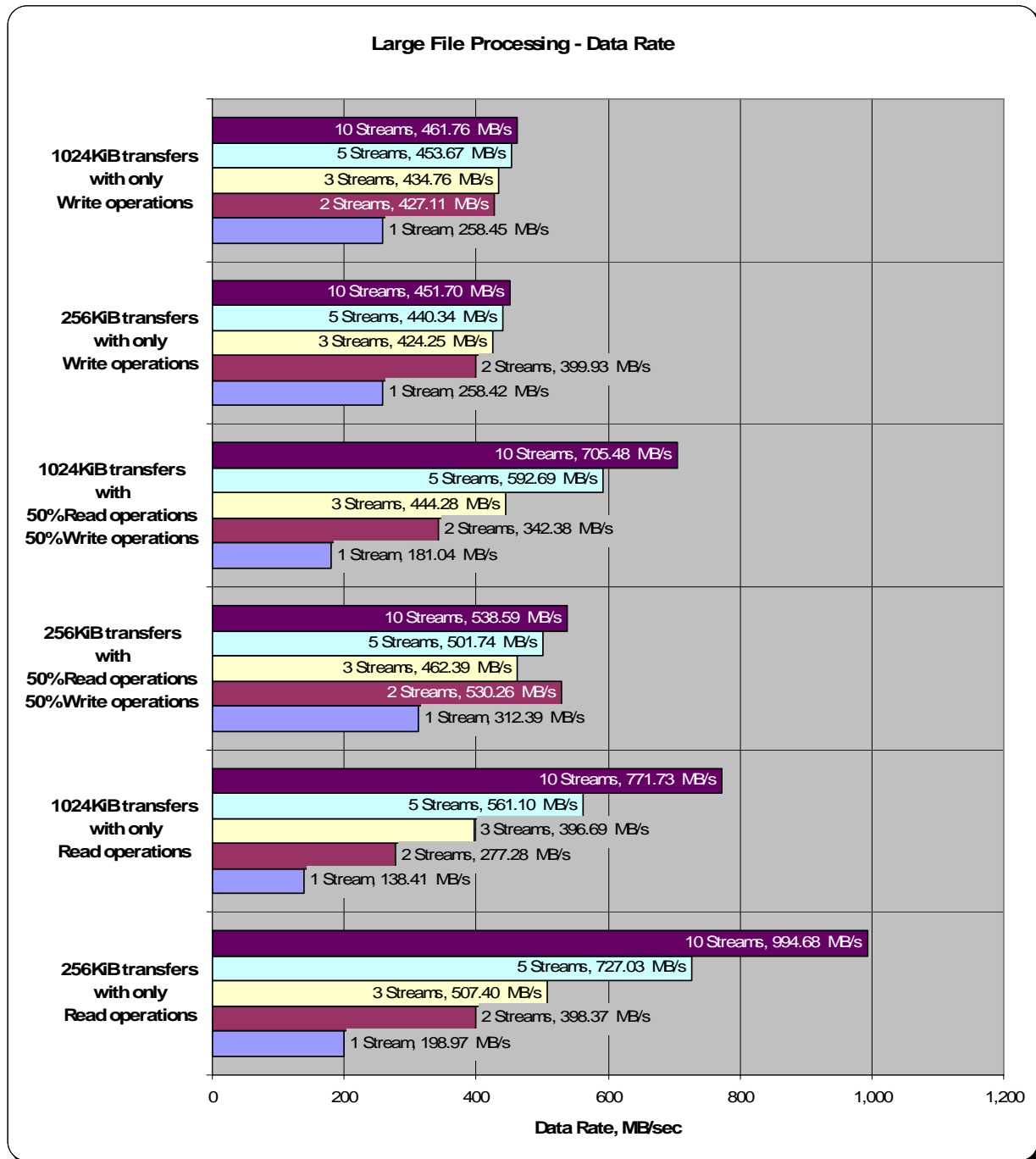

SPC-2C Large File Processing Average Data Rate per Stream

The average Data Rate per Stream for each Test Run in the three Test Phases of the SPC-2C Large File Processing Test is listed in the table below as well as illustrated in the following graph.

Test Run Sequence	1 Stream	2 Streams	3 Streams	5 Streams	10 Streams
Write 1024KiB	258.45	213.55	144.92	90.73	46.18
Write 256KiB	258.42	199.97	141.42	88.07	45.17
Read/Write 1024KiB	181.04	171.19	148.09	118.54	70.55
Read/Write 256KiB	312.39	265.13	154.13	100.35	53.86
Read 1024KiB	138.41	138.64	132.23	112.22	77.17
Read 256KiB	198.97	199.18	169.13	145.41	99.47

SPC-2C Large File Processing Average Data Rate per Stream Graph

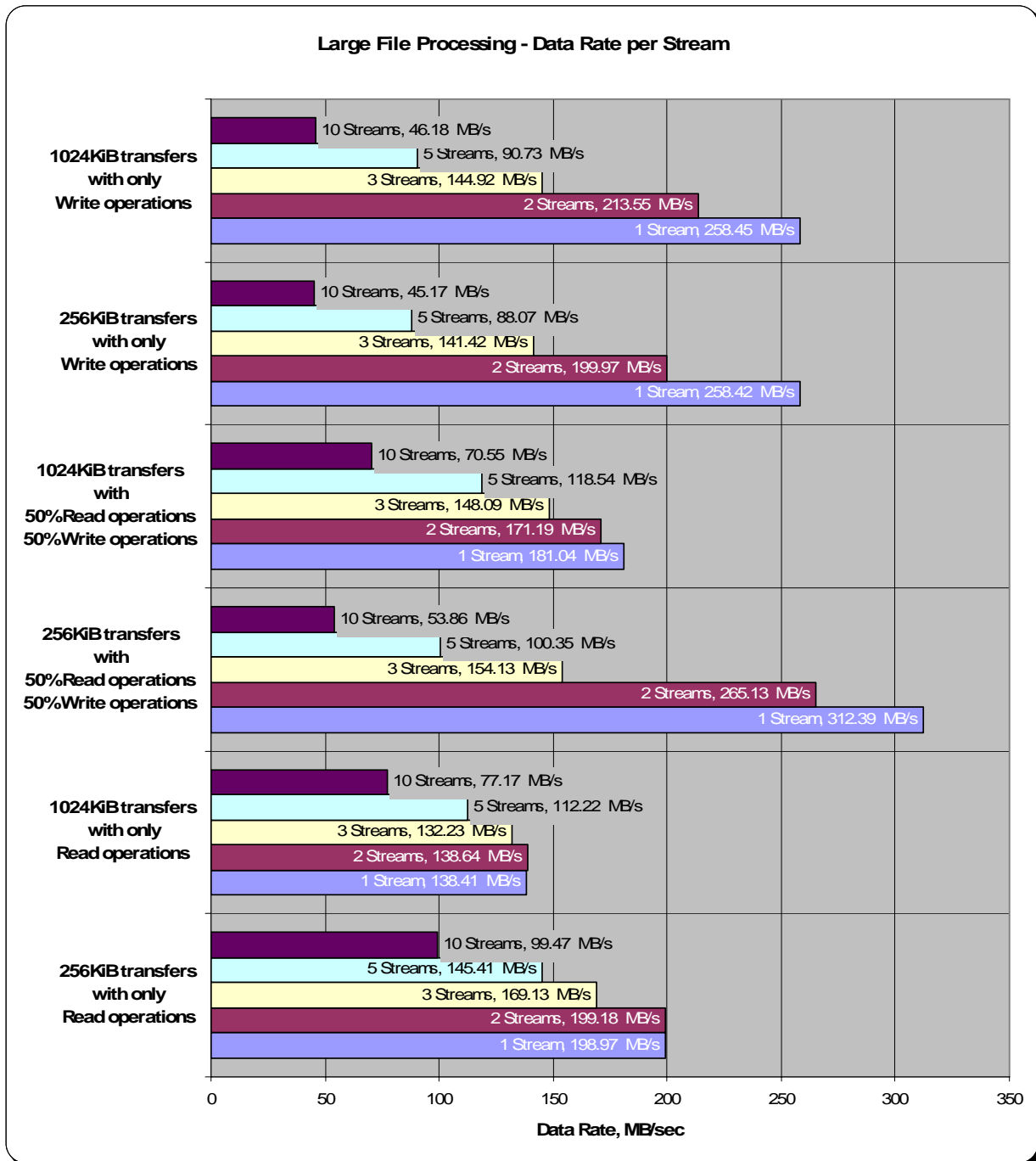

SPC-2C Large File Processing Average Response Time

The average Response Time, milliseconds (ms), for each Test Run in the three Test Phases of the SPC-2C Large File Processing Test is listed in the table below as well as illustrated in the following graph.

Test Run Sequence	1 Stream	2 Streams	3 Streams	5 Streams	10 Streams
Write 1024KiB	4.09	4.91	7.29	11.55	22.70
Write 256KiB	1.02	1.31	1.86	2.97	5.80
Read/Write 1024KiB	5.79	6.12	7.12	8.86	14.86
Read/Write 256KiB	0.84	0.99	1.70	2.62	4.86
Read 1024KiB	7.71	7.64	8.17	9.70	13.75
Read 256KiB	1.31	1.31	1.67	1.89	2.70

SPC-2C Large File Processing Average Response Time Graph

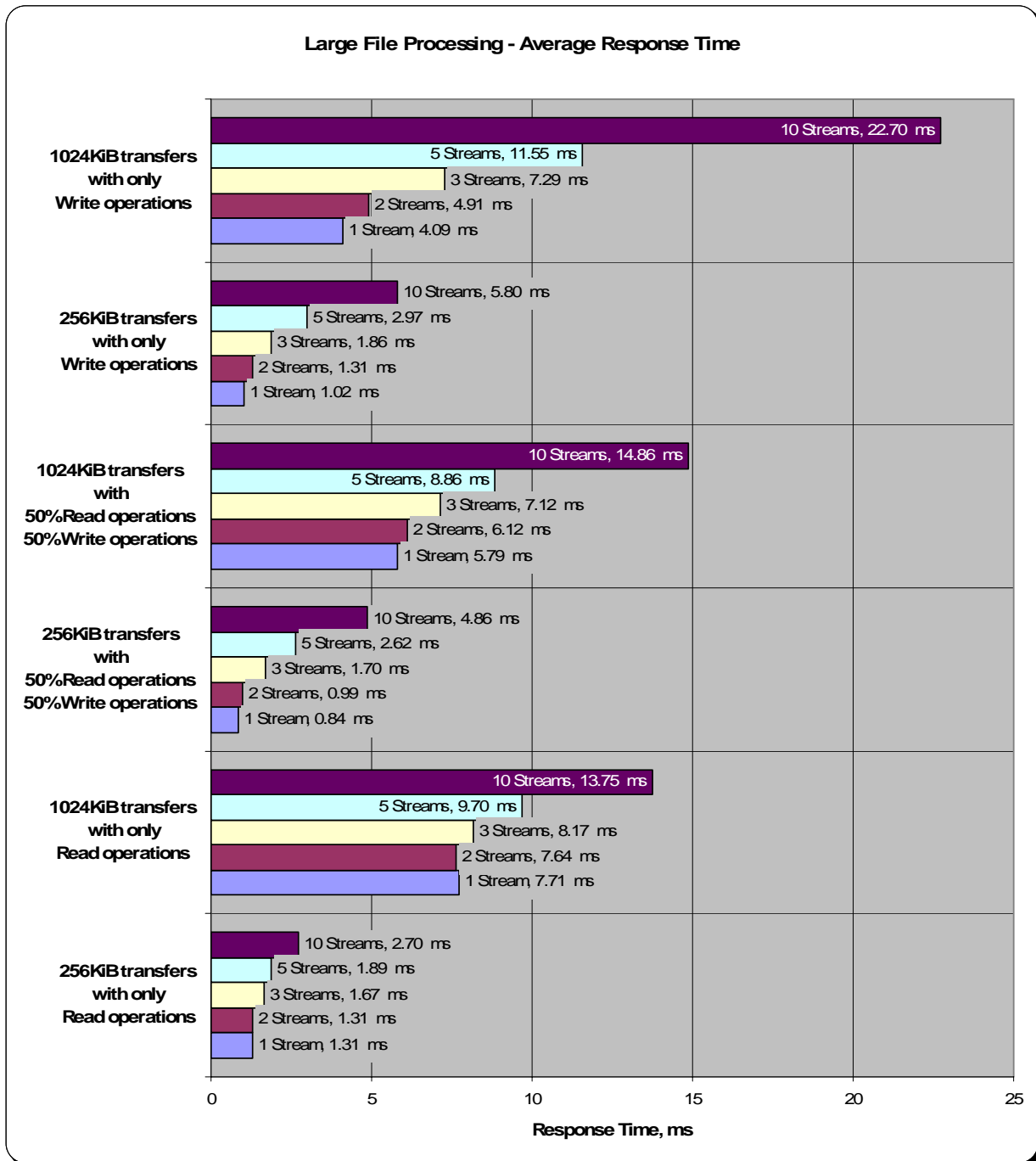

Large File Processing Test – WRITE ONLY Test Phase

Clause 10.4.8.1.1

1. A table that will contain the following information for each "WRITE ONLY, 1024 KiB Transfer Size" Test Run:
 - The number of Streams specified.
 - The average data rate, average data rate per stream, and average Response Time reported at five second intervals.
2. Average Data Rate (intervals), Average Data Rate per Stream (intervals), and Average Response Time (intervals) graphs for the "WRITE ONLY, 1024 KiB Transfer Size" Test Runs as specified in Clauses 10.1.4 – 10.1.6.
3. A table that will contain the following information for each "WRITE ONLY, 256 KiB Transfer Size" Test Run:
 - The number of Streams specified.
 - The average data rate, average data rate per stream, and average Response Time reported at five second intervals.
4. Average Data Rate (intervals), Average Data Rate per Stream (intervals), and Average Response Time (intervals) graphs for the "WRITE ONLY, 256 KiB Transfer Size" Test Runs as specified in Clauses 10.1.4 – 10.1.6.

The tables and graphs for the SPC-2C Large File Processing WRITE ONLY Test Phase are available via the link listed below.

[SPC-2C Large File Processing WRITE ONLY Test Phase – Data Tables and Graphs](#)

Large File Processing Test – READ-WRITE Test Phase

Clause 10.4.8.1.2

1. *A table that will contain the following information for each "READ-WRITE, 1024 KiB Transfer Size" Test Run:*
 - *The number of Streams specified.*
 - *The average data rate, average data rate per stream, and average Response Time reported at five second intervals.*
2. *Average Data Rate (intervals), Average Data Rate per Stream (intervals), and Average Response Time (intervals) graphs for the "READ-WRITE, 1024 KiB Transfer Size" Test Runs as specified in Clauses 10.1.4 – 10.1.6.*
3. *A table that will contain the following information for each "READ-WRITE, 256 KiB Transfer Size" Test Run:*
 - *The number of Streams specified.*
 - *The average data rate, average data rate per stream, and average Response Time reported at five second intervals.*
4. *Average Data Rate (intervals), Average Data Rate per Stream (intervals), and Average Response Time (intervals) graphs for the "READ-WRITE, 256 KiB Transfer Size" Test Runs as specified in Clauses 10.1.4 – 10.1.6.*

The tables and graphs for the SPC-2C Large File Processing READ-WRITE Test Phase are available via the link listed below.

[SPC-2C Large File Processing READ-WRITE Test Phase – Data Tables and Graphs](#)

Large File Processing Test – READ ONLY Test Phase

Clause 10.4.8.1.3

1. *A table that will contain the following information for each "READ ONLY, 1024 KiB Transfer Size" Test Run:*
 - *The number of Streams specified.*
 - *The average data rate, average data rate per stream, and average Response Time reported at five second intervals.*
2. *Average Data Rate (intervals), Average Data Rate per Stream (intervals), and Average Response Time (intervals) graphs for the "READ ONLY, 1024 KiB Transfer Size" Test Runs as specified in Clauses 10.1.4 – 10.1.6.*
3. *A table that will contain the following information for each "READ ONLY, 256 KiB Transfer Size" Test Run:*
 - *The number of Streams specified.*
 - *The average data rate, average data rate per stream, and average Response Time reported at five second intervals.*
4. *Average Data Rate (intervals), Average Data Rate per Stream (intervals), and Average Response Time (intervals) graphs for the "READ ONLY, 256 KiB Transfer Size" Test Runs as specified in Clauses 10.1.4 – 10.1.6.*

The tables and graphs for the SPC-2C Large File Processing READ ONLY Test Phase are available via the link listed below.

[SPC-2C Large File Processing READ ONLY Test Phase – Data Tables and Graphs](#)

Large Database Query Test

Clause 6.4.4.1

The Large Database Query Test is comprised of a set of I/O operations representative of scans or joins of large relational tables such as those performed for data mining or business intelligence.

Clause 6.4.4.2

The Large Database Query Test has two Test Phases, which shall be executed in the following uninterrupted sequence:

- 1. 1024 KiB TRANSFER SIZE*
- 2. 64 KiB TRANSFER SIZE*

The BC shall not be restarted or manually disturbed, altered, or adjusted during the execution of the Large File Processing Test. If power is lost to the BC during this Test all results shall be rendered invalid and the Test re-run in its entirety.

Clause 10.4.8.2

The Full Disclosure Report will contain the following content for the Large Database Query Test:

- 1. A listing of the SPC-2C Workload Generator commands and parameters used to execute each of the Test Runs in the Large Database Query Test.*
- 2. The human readable SPC-2C Test Results File for each of the Test Runs in the Large Database Query Test.*
- 3. The following three tables, defined in Clauses 10.1.1 – 10.1.3.:*
 - Average Data Rate: This table will contain the average Data Rate, in MB per second, for the Measurement Interval of each Test Run in the Large Database Query Test.*
 - Average Data Rate per Stream: This table will contain the average Data Rate per Stream, in MB per second, for the Measurement Interval of each Test Run in the Large Database Query Test.*
 - Average Response Time: This table will contain the average Response Time, in milliseconds (ms), for the Measurement Interval of each Test Run in the Large Database Query Test.*

Each table will also include the following information for each Test Run:

- The number of Streams specified.*
 - The Ramp-Up duration in seconds.*
 - The Measurement Interval duration in seconds.*
- 4. Average Data Rate, Average Data Rate per Stream, and Average Response Time graphs as defined in Clauses 10.1.1, 10.1.2, and 10.1.3.*

SPC-2C Workload Generator Commands and Parameters

The SPC-2C Workload Generator commands and parameters for the Large Database Query Test Runs are documented in “Appendix E: SPC-2C Workload Generator Execution Commands and Parameters” on Page 60.

SPC-2C Test Results File

A link to the SPC-2C Test Results file generated from the Large Database Query Test Runs is listed below.

[SPC-2C Large Database Query Test Results File](#)

SPC-2C Large Database Query Average Data Rates (MB/s)

The average Data Rate (MB/s) for each Test Run in the two Test Phases of the SPC-2C Large Database Query Test is listed in the table below as well as illustrated in the following graph.

Test Run Sequence	1 Stream	2 Streams	3 Streams	5 Streams	10 Streams
1024KiB w/ 4 IOs/Stream	203.02	405.79	595.96	850.34	1,308.79
1024KiB w/ 1 IO/Stream	138.56	268.35	347.71	538.57	771.92
64KiB w/ 4 IOs/Stream	192.49	369.68	504.35	643.69	873.41
64KiB w/ 1 IO/Stream	193.13	368.01	432.74	465.85	557.69

SPC-2C Large Database Query Average Data Rates Graph

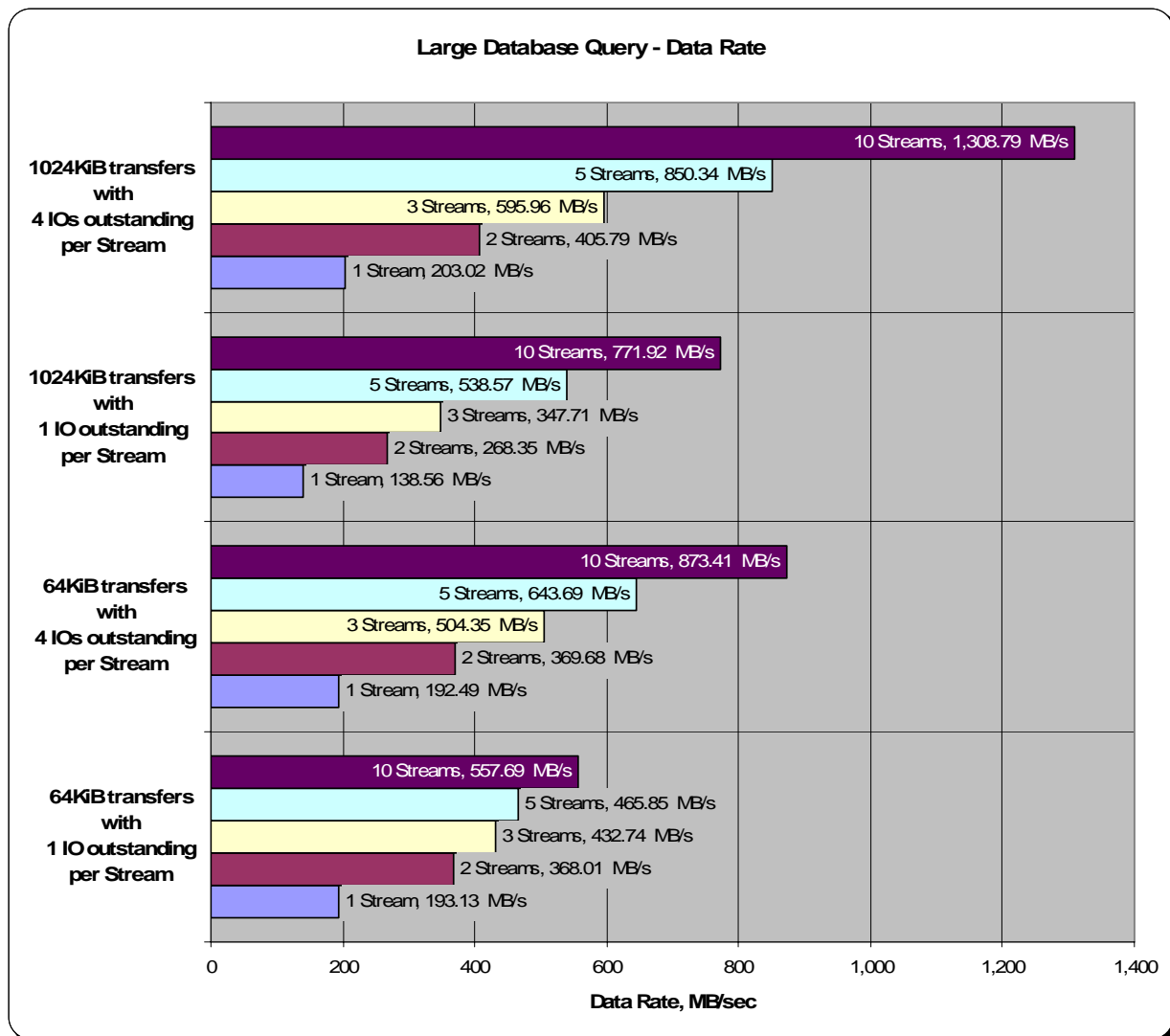

SPC-2C Large Database Query Average Data Rate per Stream

The average Data Rate per Stream for each Test Run in the two Test Phases of the SPC-2C Large Database Query Test is listed in the table below as well as illustrated in the following graph.

Test Run Sequence	1 Stream	2 Streams	3 Streams	5 Streams	10 Streams
1024KiB w/ 4 IOs/Stream	203.02	202.89	198.65	170.07	130.88
1024KiB w/ 1 IO/Stream	138.56	134.17	115.90	107.71	77.19
64KiB w/ 4 IOs/Stream	192.49	184.84	168.12	128.74	87.34
64KiB w/ 1 IO/Stream	193.13	184.01	144.25	93.17	55.77

SPC-2C Large Database Query Average Data Rate per Stream Graph

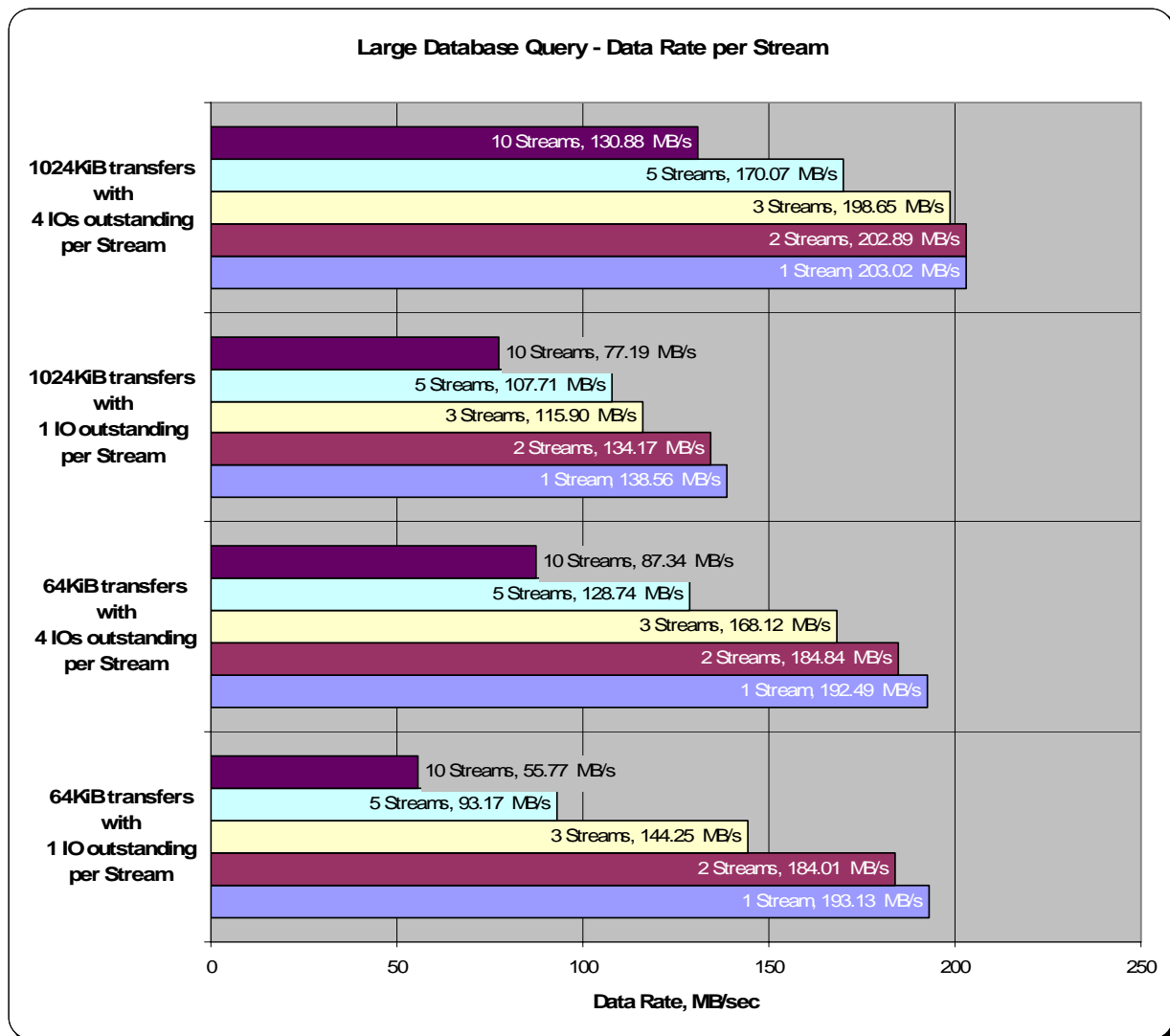

SPC-2C Large Database Query Average Response Time

The average Response Time, in milliseconds, for each Test Run in the two Test Phases of the SPC-2C Large Database Query Test is listed in the table below as well as illustrated in the following graph.

Test Run Sequence	1 Stream	2 Streams	3 Streams	5 Streams	10 Streams
1024KiB w/ 4 IOs/Stream	20.70	20.67	21.18	24.87	32.26
1024KiB w/ 1 IO/Stream	7.67	7.86	9.48	10.01	13.77
64KiB w/ 4 IOs/Stream	1.37	1.42	1.58	2.10	3.01
64KiB w/ 1 IO/Stream	0.34	0.35	0.47	0.72	1.17

SPC-2C Large Database Query Average Response Time Graph

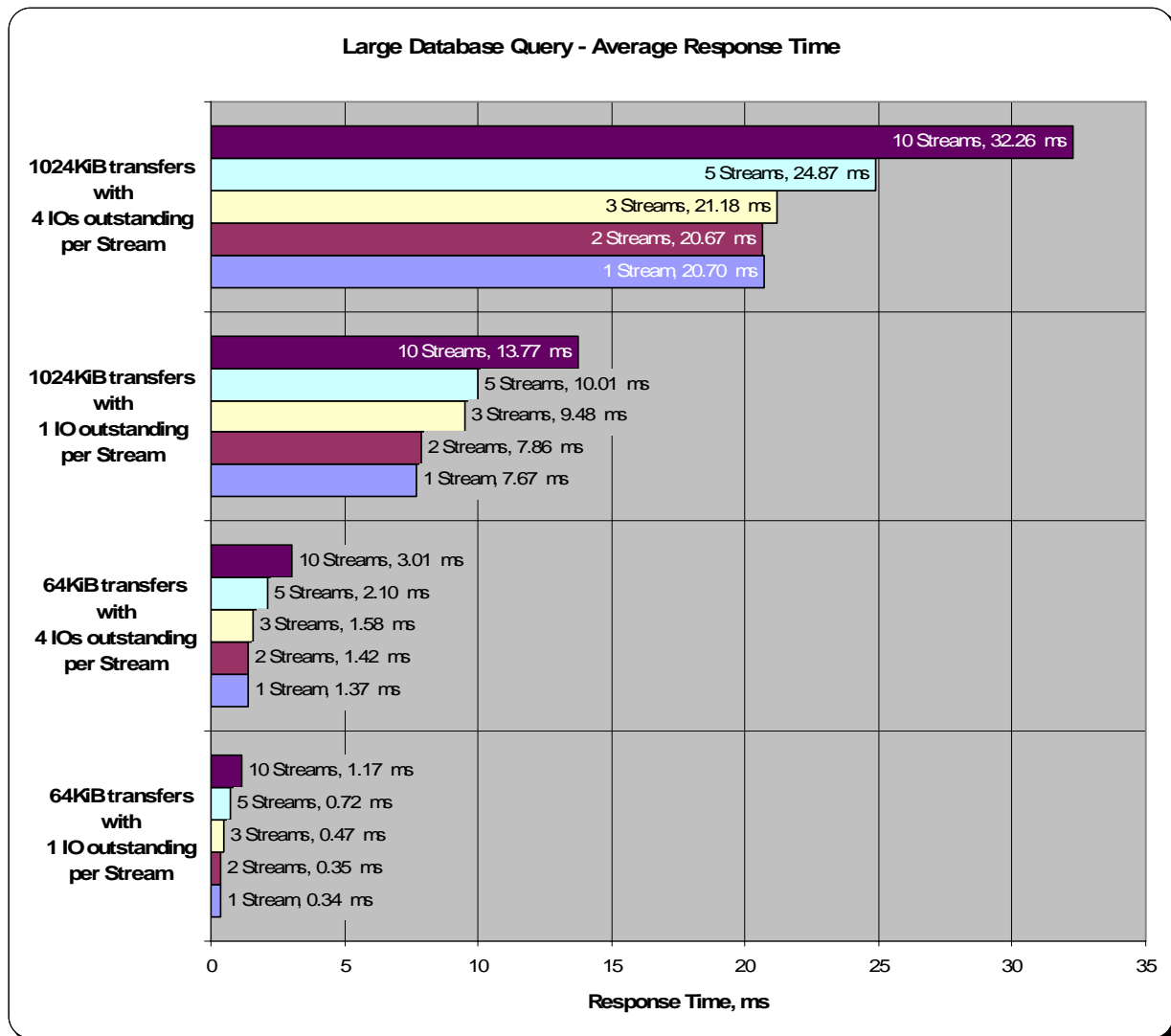

Large Database Query Test – 1024 KiB TRANSFER SIZE Test Phase

Clause 10.4.8.2.1

1. *A table that will contain the following information for each "1024 KiB Transfer Size, 4 Outstanding I/Os" Test Run:*
 - *The number of Streams specified.*
 - *The average data rate, average data rate per stream, and average Response Time reported at five second intervals.*
2. *Average Data Rate by Intervals, Average Data Rate per Stream by Intervals, and Average Response Time by Intervals graphs for the "1024 KiB TRANSFER SIZE, 4 Outstanding I/Os" Test Runs as specified in Clauses 10.1.4 – 10.1.6.*
3. *A table that will contain the following information for each "1024 KiB Transfer Size, 1 Outstanding I/O" Test Run:*
 - *The number of Streams specified.*
 - *The average data rate, average data rate per stream, and average Response Time reported at five second intervals.*
4. *Average Data Rate by Intervals, Average Data Rate per Stream by Intervals, and Average Response Time by Intervals graphs for the "1024 KiB TRANSFER SIZE, 4 Outstanding I/Os" Test Runs as specified in Clauses 10.1.4 – 10.1.6.*

The tables and graphs for the SPC-2C Large Database Query 1024 KiB TRANSFER Test Phase are available via the link listed below.

[SPC-2C Large Database Query 1024 KiB TRANSFER SIZE Test Phase – Data Tables and Graphs](#)

Large Database Query Test – 64 KiB TRANSFER SIZE Test Phase

Clause 10.4.8.2.2

1. *A table that will contain the following information for each "64 KiB Transfer Size, 4 Outstanding I/Os" Test Run:*
 - *The number of Streams specified.*
 - *The average data rate, average data rate per stream, and average Response Time reported at five second intervals.*
2. *Average Data Rate by Intervals, Average Data Rate per Stream by Intervals, and Average Response Time by Intervals graphs for the "64 KiB TRANSFER SIZE, 4 Outstanding I/Os" Test Runs as specified in Clauses 10.1.4 – 10.1.6.*
3. *A table that will contain the following information for each "64 KiB Transfer Size, 1 Outstanding I/O" Test Run:*
 - *The number of Streams specified.*
 - *The average data rate, average data rate per stream, and average Response Time reported at five second intervals.*
4. *Average Data Rate by Intervals, Average Data Rate per Stream by Intervals, and Average Response Time by Intervals graphs for the "64 KiB TRANSFER SIZE, 4 Outstanding I/Os" Test Runs as specified in Clauses 10.1.4 – 10.1.6.*

The tables and graphs for the SPC-2C Large Database Query 64 KiB TRANSFER Test Phase are available via the link listed below.

[SPC-2C Large Database Query 64 KiB TRANSFER SIZE Test Phase – Data Tables and Graphs](#)

Video on Demand Delivery Test

Clause 6.4.5.1

The Video on Demand Delivery Test represents the I/O operations required to enable individualized video entertainment for a community of subscribers, which draw from a digital film library.

Clause 6.4.5.2

The Video on Demand Delivery Test consists of one (1) Test Run.

The BC shall not be restarted or manually disturbed, altered, or adjusted during the execution of the Video on Demand Delivery Test. If power is lost to the BC during this Test all results shall be rendered invalid and the Test re-run in its entirety.

Clause 10.4.8.3

The Full Disclosure Report will contain the following content for the Video on Demand Delivery Test:

- 1. A listing of the SPC-2C Workload Generator commands and parameters used to execute the Test Run in the Video on Demand Delivery Test.*
- 2. The human readable SPC-2C Test Results File for the Test Run in the Video on Demand Delivery Test.*
- 3. A table that contains the following information for the Test Run in the Video on Demand Delivery Test:*
 - The number Streams specified.*
 - The Ramp-Up duration in seconds.*
 - The Measurement Interval duration in seconds.*
 - The average data rate, in MB per second, for the Measurement Interval.*
 - The average data rate, in MB per second, per Stream for the Measurement Interval.*
- 4. A table that contains the following information for the single Video on Demand Delivery Test Run:*
 - The number Streams specified.*
 - The average data rate, average data rate per stream, average Response Time, and Maximum Response Time reported at 60 second intervals.*
- 5. Average Data Rate by Interval and Average Response Time by Interval graphs for the single Video on Demand Delivery Test Run as specified in Clauses 10.1.4-2-10.1.6.*
- 6. A Maximum Response Time (intervals) graph as specified in Clause 10.1.9.*

SPC-2C Workload Generator Commands and Parameters

The SPC-2C Workload Generator commands and parameters for the Video on Demand Delivery Test Run are documented in “Appendix E: SPC-2C Workload Generator Execution Commands and Parameters” on Page 60.

SPC-2C Test Results File

A link to the SPC-2C Test Results file generated from the Video on Demand Delivery Test Run is listed below.

[SPC-2C Video on Demand Delivery Test Results File](#)

SPC-2C Video on Demand Delivery Test Run Data

The number of Streams specified, Ramp-Up duration in seconds, Measurement Interval duration in seconds, average Data Rate for the Measurement Interval, and average Data Rate per Stream for the Measurement Interval are listed in the following table.

SPC-2-VOD	TR1
Number of Streams	660
Ramp-up Time, sec	1200
Measurement Interval, sec	7200
Average Data Rate, MB/sec	519.05
Per Stream Data Rate, MB/sec	0.79
Average Response Time, ms	58.29
Average Max Response Time, ms	360.15

Video on Demand Delivery Test – TEST RUN DATA BY INTERVAL

The SPC-2C Video on Demand Delivery Test Run data is contained in the table that appears on the next page. That table is followed by graphs illustrating the average Data Rate and average Data Rate per Stream produced by the same Test Runs. The table and graphs present the data at sixty second intervals.

TR1					TR1					TR1				
Test Run Sequence Time	660 Streams				Test Run Sequence Time	660 Streams				Test Run Sequence Time	660 Streams			
	Data Rate, MB/sec	Data Rate / Stream, MB/sec	Response Time, ms	Maximum Response Time, ms		Data Rate, MB/sec	Data Rate / Stream, MB/sec	Response Time, ms	Maximum Response Time, ms		Data Rate, MB/sec	Data Rate / Stream, MB/sec	Response Time, ms	Maximum Response Time, ms
0:01:00	48.89	0.66	3.53	22.16	0:51:00	519.05	0.79	55.97	325.68	1:41:00	519.04	0.79	60.43	355.11
0:02:00	136.42	0.77	7.24	83.66	0:52:00	519.03	0.79	55.77	330.23	1:42:00	519.03	0.79	59.21	360.77
0:03:00	209.54	0.77	9.03	46.80	0:53:00	519.05	0.79	56.85	335.17	1:43:00	519.06	0.79	56.73	347.95
0:04:00	272.55	0.78	11.48	72.74	0:54:00	518.99	0.79	56.48	330.42	1:44:00	518.91	0.79	57.12	296.47
0:05:00	324.65	0.78	15.25	115.44	0:55:00	519.07	0.79	56.68	326.75	1:45:00	519.01	0.79	60.00	338.87
0:06:00	367.33	0.78	18.93	147.35	0:56:00	519.04	0.79	56.41	339.86	1:46:00	519.04	0.79	62.29	348.48
0:07:00	415.49	0.78	26.68	191.10	0:57:00	519.03	0.79	56.55	338.16	1:47:00	519.17	0.79	60.49	326.91
0:08:00	450.39	0.78	33.61	211.31	0:58:00	519.03	0.79	57.72	344.69	1:48:00	519.01	0.79	58.62	313.84
0:09:00	477.42	0.78	44.26	270.25	0:59:00	519.13	0.79	57.99	349.17	1:49:00	518.93	0.79	57.85	373.22
0:10:00	506.84	0.78	58.75	353.60	1:00:00	519.03	0.79	58.26	354.89	1:50:00	519.11	0.79	58.16	365.80
0:11:00	519.04	0.79	64.63	358.48	1:01:00	519.07	0.79	57.50	385.48	1:51:00	519.03	0.79	59.18	453.87
0:12:00	518.99	0.79	64.56	374.24	1:02:00	519.05	0.79	56.53	351.52	1:52:00	519.11	0.79	58.66	429.88
0:13:00	519.14	0.79	64.27	379.72	1:03:00	519.07	0.79	55.18	329.14	1:53:00	518.96	0.79	59.30	384.43
0:14:00	519.04	0.79	64.64	391.22	1:04:00	519.00	0.79	53.82	298.95	1:54:00	518.98	0.79	59.44	463.73
0:15:00	519.00	0.79	65.34	398.71	1:05:00	519.06	0.79	55.57	332.93	1:55:00	519.01	0.79	57.86	413.49
0:16:00	518.98	0.79	64.96	389.10	1:06:00	519.02	0.79	53.96	303.14	1:56:00	518.91	0.79	57.71	391.55
0:17:00	519.03	0.79	64.28	384.36	1:07:00	519.02	0.79	57.65	321.41	1:57:00	519.01	0.79	57.59	400.69
0:18:00	519.06	0.79	64.26	406.92	1:08:00	519.06	0.79	57.16	341.88	1:58:00	519.04	0.79	56.97	377.81
0:19:00	519.09	0.79	64.23	385.55	1:09:00	518.98	0.79	57.82	370.45	1:59:00	519.13	0.79	57.18	410.27
0:20:00	518.97	0.79	64.18	382.96	1:10:00	518.99	0.79	57.60	436.23	2:00:00	519.06	0.79	57.27	381.80
0:21:00	519.06	0.79	62.53	387.80	1:11:00	519.10	0.79	57.41	415.96	2:01:00	519.08	0.79	58.27	347.83
0:22:00	519.13	0.79	57.25	355.71	1:12:00	519.03	0.79	57.31	353.65	2:02:00	519.07	0.79	57.96	331.40
0:23:00	519.04	0.79	57.23	321.16	1:13:00	519.05	0.79	57.01	387.02	2:03:00	519.05	0.79	56.95	340.72
0:24:00	518.99	0.79	58.85	365.37	1:14:00	519.11	0.79	56.69	363.72	2:04:00	519.02	0.79	58.04	312.92
0:25:00	518.99	0.79	59.45	350.87	1:15:00	519.01	0.79	56.75	368.19	2:05:00	519.04	0.79	57.01	308.83
0:26:00	519.02	0.79	60.98	382.16	1:16:00	519.04	0.79	56.81	371.77	2:06:00	519.05	0.79	56.67	323.15
0:27:00	518.96	0.79	60.55	387.08	1:17:00	519.11	0.79	57.23	383.41	2:07:00	519.14	0.79	55.13	321.24
0:28:00	519.02	0.79	59.74	388.25	1:18:00	519.06	0.79	57.15	373.29	2:08:00	519.06	0.79	55.73	330.95
0:29:00	518.98	0.79	60.61	359.80	1:19:00	519.09	0.79	57.31	375.63	2:09:00	519.02	0.79	58.29	336.03
0:30:00	519.08	0.79	61.36	364.15	1:20:00	519.00	0.79	56.78	371.89	2:10:00	519.01	0.79	55.53	339.55
0:31:00	519.08	0.79	61.63	357.07	1:21:00	519.08	0.79	58.08	376.68	2:11:00	519.06	0.79	55.38	358.65
0:32:00	519.13	0.79	62.66	370.55	1:22:00	519.06	0.79	56.90	365.40	2:12:00	518.99	0.79	55.01	348.50
0:33:00	519.08	0.79	62.66	356.38	1:23:00	519.05	0.79	56.36	343.28	2:13:00	519.08	0.79	55.27	343.39
0:34:00	519.04	0.79	61.09	350.62	1:24:00	519.10	0.79	54.75	348.01	2:14:00	519.09	0.79	54.84	346.32
0:35:00	519.12	0.79	60.80	365.47	1:25:00	518.96	0.79	56.73	435.07	2:15:00	519.08	0.79	55.35	331.51
0:36:00	519.05	0.79	61.50	369.16	1:26:00	518.57	0.79	74.40	686.07	2:16:00	519.05	0.79	54.59	338.57
0:37:00	519.03	0.79	60.79	361.09	1:27:00	519.63	0.79	82.27	766.52	2:17:00	519.13	0.79	54.67	327.01
0:38:00	518.98	0.79	61.72	367.83	1:28:00	518.96	0.79	57.50	435.91	2:18:00	519.10	0.79	55.11	303.47
0:39:00	519.04	0.79	61.43	358.01	1:29:00	518.99	0.79	57.34	349.76	2:19:00	518.99	0.79	53.96	310.94
0:40:00	518.99	0.79	61.59	372.23	1:30:00	519.08	0.79	58.72	315.55	2:20:00	519.08	0.79	53.72	320.15
0:41:00	519.12	0.79	63.18	393.90	1:31:00	519.04	0.79	58.79	306.55					
0:42:00	519.03	0.79	59.76	359.54	1:32:00	519.04	0.79	58.48	316.78					
0:43:00	519.05	0.79	60.30	393.65	1:33:00	519.01	0.79	58.60	324.83					
0:44:00	519.05	0.79	58.59	351.36	1:34:00	519.10	0.79	58.48	322.34					
0:45:00	519.05	0.79	58.47	341.33	1:35:00	519.16	0.79	58.61	321.72					
0:46:00	519.05	0.79	57.15	309.04	1:36:00	519.10	0.79	58.42	324.32					
0:47:00	519.02	0.79	57.87	323.22	1:37:00	519.00	0.79	58.74	321.05					
0:48:00	519.12	0.79	59.07	336.96	1:38:00	519.05	0.79	58.35	329.66					
0:49:00	519.05	0.79	56.98	307.96	1:39:00	519.05	0.79	58.28	306.28					
0:50:00	519.04	0.79	55.94	317.14	1:40:00	519.05	0.79	58.33	328.59					

SPC-2C Video on Demand Delivery Average Data Rate Graph

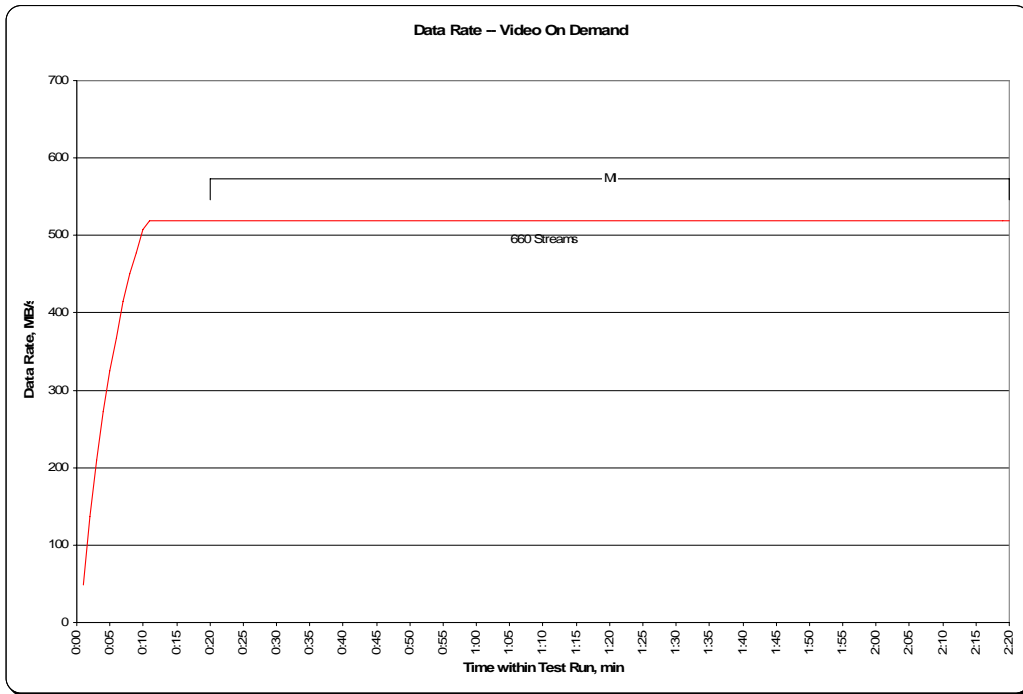

SPC-2C Video on Demand Delivery Average Data Rate per Stream Graph

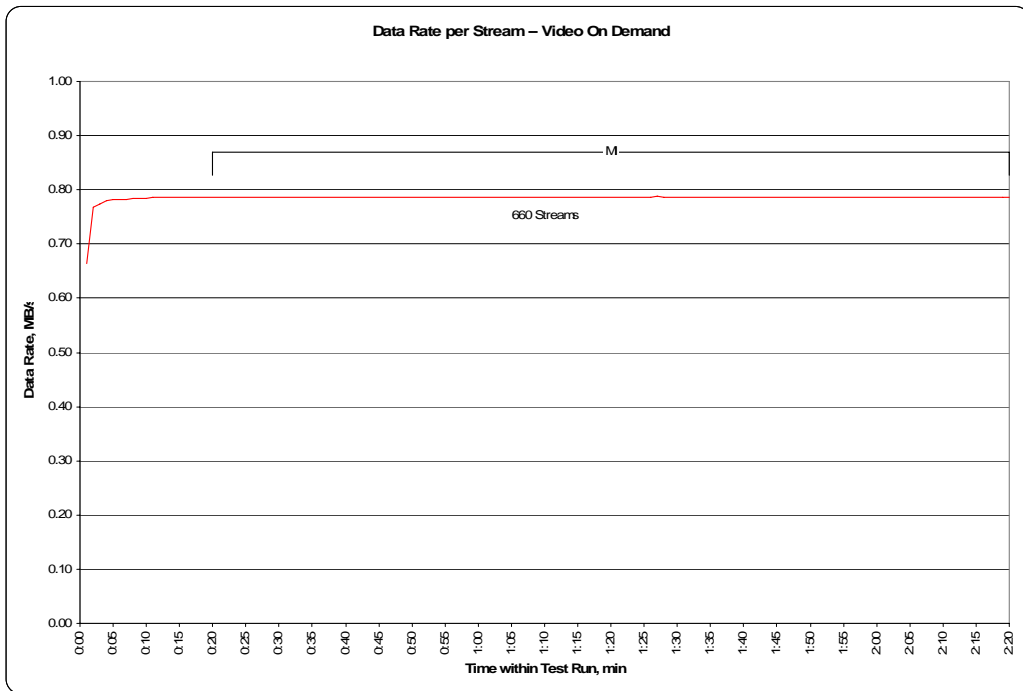

SPC-2C Video on Demand Delivery Average Response Time Graph

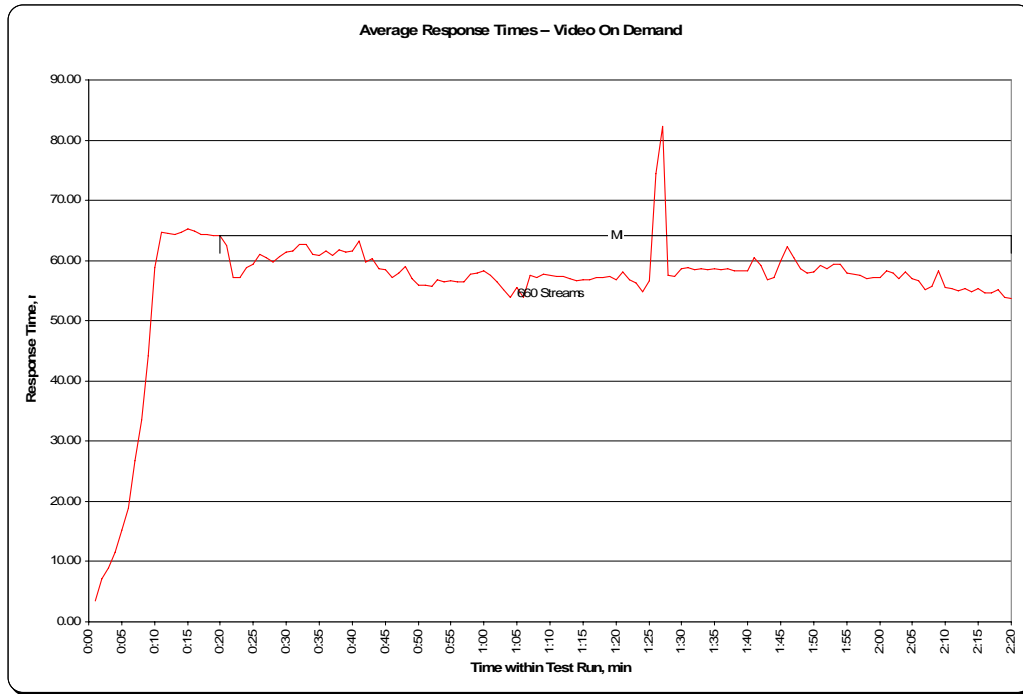

SPC-2C Video on Demand Delivery Maximum Response Time Graph

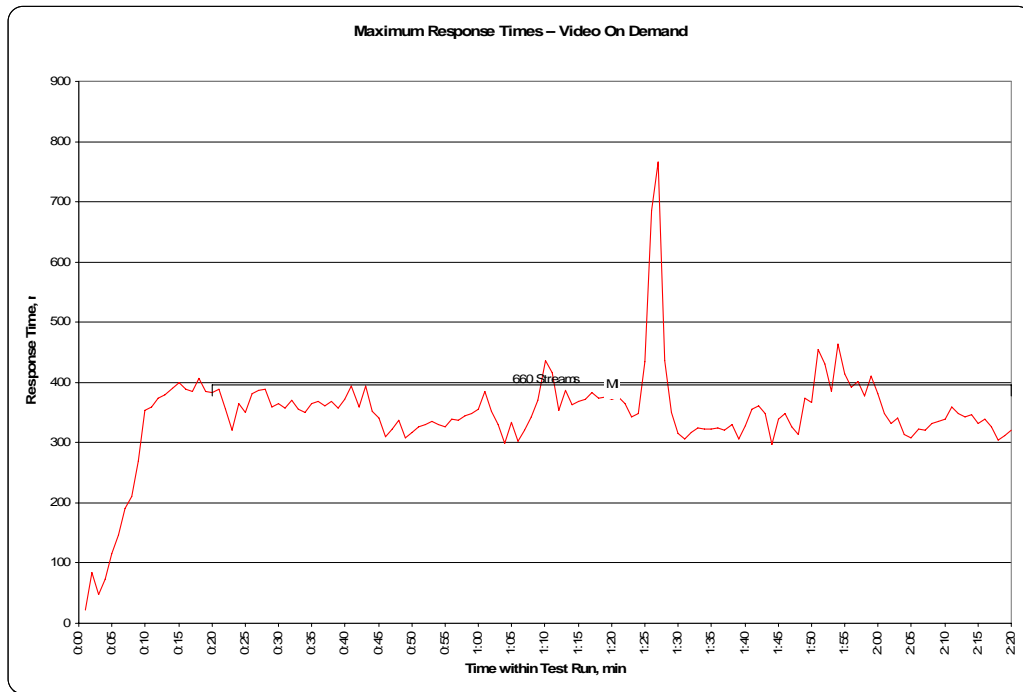

Data Persistence Test

Clause 7

The Data Persistence Test demonstrates the Tested Storage Configuration (TSC):

- *Is capable of maintain data integrity across a power cycle.*
- *Ensures the transfer of data between Logical Volumes and host systems occurs without corruption or loss.*

The SPC-2C Workload Generator will write a specific pattern at randomly selected locations throughout the Total ASU Capacity (Persistence Test Run 1). The SPC-2C Workload Generator will retain the information necessary to later validate the pattern written at each location.

The Tested Storage Configuration will be shutdown and restarted using a power off/power on cycle at the end of the above sequence of write operations. In addition, any caches employing battery backup must be flushed/emptied.

Restart the TSC, and if the Host System(s) were shutdown and powered off, restart the Host System(s).

The SPC-2C Workload Generator will utilize the retained data from Persistence Test Run 1 to verify (Persistence Run 2) the bit patterns written in Persistence Test Run 1 and their corresponding location.

Clause 10.4.8.4

The Full Disclosure Report will contain the following content for the Data Persistence Test:

1. *A listing of the SPC-2C Workload Generator commands and parameters used to execute each of the Test Runs in the Persistence Test.*
2. *The human readable SPC-2C Test Results File for each of the Test Runs in the Data Persistence Test.*
3. *A table from the successful Persistence Test, which contains the results from the test.*

SPC-2C Workload Generator Commands and Parameters

The SPC-2C Workload Generator commands and parameters for the Persistence Test Runs are documented in “Appendix E: SPC-2C Workload Generator Execution Commands and Parameters” on Page 60.

Data Persistence Test Results File

A link to the test result file generated from each Data Persistence Test Run is listed below.

[Persistence 1 Test Run Results File](#)

[Persistence 2 Test Run Results File](#)

Data Persistence Test Results

Data Persistence Test Results	
Data Persistence Test Number: 1	
Total Number of Logical Blocks Written	198,720
Total Number of Logical Blocks Re-referenced	56,523
Total Number of Logical Blocks Verified	142,197
Total Number of Logical Blocks that Failed Verification	0
Number of Failed I/O Requests in the process of the Test	0

PRICED STORAGE CONFIGURATION AVAILABILITY DATE

Clause 10.4.9

The committed delivery date for general availability (Availability Date) of all products that comprise the Priced Storage Configuration must be reported. When the Priced Storage Configuration includes products or components with different availability dates, the reported Availability Date must be the date at which all components are committed to be available. All availability dates, whether for individual components or for the Priced Storage Configuration as a whole, must be disclosed to a precision of one day.

The Availability Date shall be stated in the FDR by either a combination of specific alphanumeric month, numeric day, and numeric year or as "Currently Available" in the case where all components that comprise the PSC are currently available for customer order and shipment.

The LSI MegaRAID SAS 8888ELP, as documented in this SPC-2C Full Disclosure Report, is currently available for customer purchase and shipment.

ANOMALIES OR IRREGULARITIES

Clause 10.4.11

The FDR shall include a clear and complete description of any anomalies or irregularities encountered in the course of executing the SPC-2C benchmark that may in any way call into question the accuracy, verifiability, or authenticity of information published in this FDR.

There were no anomalies or irregularities encountered during the SPC-2C Onsite Audit of the LSI MegaRAID SAS 8888ELP.

APPENDIX A: SPC-2C GLOSSARY

“Decimal” (*powers of ten*) Measurement Units

In the storage industry, the terms “kilo”, “mega”, “giga”, “tera”, “peta”, and “exa” are commonly used prefixes for computing performance and capacity. For the purposes of the SPC workload definitions, all of the following terms are defined in “powers of ten” measurement units.

- A kilobyte (KB) is equal to 1,000 (10^3) bytes.
- A megabyte (MB) is equal to 1,000,000 (10^6) bytes.
- A gigabyte (GB) is equal to 1,000,000,000 (10^9) bytes.
- A terabyte (TB) is equal to 1,000,000,000,000 (10^{12}) bytes.
- A petabyte (PB) is equal to 1,000,000,000,000,000 (10^{15}) bytes
- An exabyte (EB) is equal to 1,000,000,000,000,000,000 (10^{18}) bytes

“Binary” (*powers of two*) Measurement Units

The sizes reported by many operating system components use “powers of two” measurement units rather than “power of ten” units. The following standardized definitions and terms are also valid and may be used in this document.

- A kibibyte (KiB) is equal to 1,024 (2^{10}) bytes.
- A mebibyte (MiB) is equal to 1,048,576 (2^{20}) bytes.
- A gibibyte (GiB) is equal to 1,073,741,824 (2^{30}) bytes.
- A tebibyte (TiB) is equal to 1,099,511,627,776 (2^{40}) bytes.
- A pebibyte (PiB) is equal to 1,125,899,906,842,624 (2^{50}) bytes.
- An exbibyte (EiB) is equal to 1,152,921,504,606,846,967 (2^{60}) bytes.

SPC-2C Data Repository Definitions

Total ASU Capacity: The total storage capacity read and written in the course of executing the SPC-2C benchmark.

Application Storage Unit (ASU): The logical interface between the storage and SPC-2C Workload Generator. The ASU is implemented on one or more Logical Volume.

Logical Volume: The division of Addressable Storage Capacity into individually addressable logical units of storage used in the SPC-2C benchmark. Each Logical Volume is implemented as a single, contiguous address space.

Addressable Storage Capacity: The total storage (sum of Logical Volumes) that can be read and written by application programs such as the SPC-2C Workload Generator.

Configured Storage Capacity: This capacity includes the Addressable Storage Capacity and any other storage (parity disks, hot spares, etc.) necessary to implement the Addressable Storage Capacity.

Physical Storage Capacity: The formatted capacity of all storage devices physically present in the Tested Storage Configuration (TSC).

Data Protection Overhead: The storage capacity required to implement the selected level of data protection.

Required Storage: The amount of Configured Storage Capacity required to implement the Addressable Storage Configuration, excluding the storage required for the ASU.

Global Storage Overhead: The amount of Physical Storage Capacity that is required for storage subsystem use and unavailable for use by application programs.

Total Unused Storage: The sum of unused storage capacity within the Physical Storage Capacity, Configured Storage Capacity, and Addressable Storage Capacity.

SPC-2C Data Protection Levels

Protected: Data protection is provided in the event of a single point of failure of any of the configured storage devices. A brief description of the data protection must be included in the FDR.

Unprotected: There is no data protection provided.

SPC-2C Test Execution Definitions

Completed I/O Request: An I/O Request with a Start Time and a Completion Time (*see "I/O Completion Types" illustrated below*).

Completion Time: The time recorded by the Workload Generator when an I/O Request is completed by the Tested Storage Configuration (TSC) as signaled by System Software.

Data Rate: The data volume, in MB, transferred by all Measured I/O Requests in an SPC-2C Test Run divided by the length of the Test Run in seconds.

Failed I/O Request: Any I/O Request issued by the SPC-2C Workload Generator that meets one of the following conditions (*see "I/O Completion Types" illustrated below*):

- The I/O Request was signaled as failed by System Software.
- The I/O Request started within the Measurement Interval, but did not complete prior to the end of the appropriate Run-Out period..
- The I/O Request started within the Run-Out period, but did not complete prior to the end of the appropriate Ramp-Down period.

I/O Request Throughput: The total number of Measured I/O Requests in an SPC-2C Test Run divided by the duration of the Measurement Interval in seconds.

Measured I/O Request: A Completed I/O Request that begins (Start Time) within a Measurement Interval and completes (Completion Time) prior to the end of the appropriate Ramp Down (see “I/O Completion Types” illustrated below).

Measurement Interval: A specified, contiguous period of time, after the TSC has reached Steady State, when data is collected by the Workload Generator to produce the test results for a SPC-2C Test Run (see “SPC-2C Test Run Components” illustrated below, Test Run 1: T_2-T_3 and Test Run 2: T_7-T_8).

Outstanding I/O Requests: The Outstanding I/O Requests parameter specifies the maximum number of concurrent I/O Requests, associated with a give Stream, which have been issued but not yet completed. (Clause 3.4.4 of the SPC-2C Benchmark Specification).

Ramp-Down: A specified, contiguous period of time in which the TSC is required to complete I/O Requests started but not completed during the preceding Run-Out period. Ramp-Down begins at the end of the preceding Run-Out period (see “SPC-2C Test Run Components” illustrated below, Test Run 1: T_4-T_5 and Test Run 2: T_9-T_{10}). The Workload Generator will not submit any I/O Requests during the Ramp-Down.

Ramp-Up: A specified, contiguous period of time required for the Benchmark Configuration (BC) to produce Steady State throughput after the Workload Generator begins submitting I/O Requests to the TSC for execution. The Ramp-Up period ends at the beginning of the Measurement Interval (see “SPC-2C Test Run Components” illustrated below, Test Run 1: T_0-T_2 and Test Run 2: T_5-T_7).

Response Time: The Response Time of a Measured I/O Request is its Completion Time minus its Start Time.

Run-Out: A specified, contiguous period of time in which the TSC is required to complete I/O Requests started but not completed during the preceding Measurement Interval. The Run-Out period begins at the end of the preceding Measurement Interval and is a component of the Steady State period (see “SPC-2C Test Run Components” illustrated below, Test Run 1: T_3-T_4 and Test Run 2: T_9-T_{10}). The Workload Generator will continue to submit I/O Requests at the Test Run’s specified rate during the Run-Out period.

Start Time: The time recorded by the Workload Generator when an I/O Request is submitted, by the Workload Generator, to the System Software for execution on the TSC.

Steady State: The period during which the workload presented to the TSC by the SPC-2C Workload Generator is constant and the resulting TSC I/O Request Throughput is both consistent and sustainable. The Steady State period includes both the Measurement Interval and Run-Out periods (see “SPC-2C Test Run Components” illustrated below, Test Run 1: T_1-T_4 and Test Run 2: T_6-T_9).

Steady State is achieved only after caches in the TSC have filled and as a result the I/O Request Throughput of the TSC has stabilized.

Stream: A collection of Stream Segments that started within a Test Run.

Stream Segment: A sequentially organized pattern of I/O requests, which transfers a contiguous range of data.

Test: A collection of Test Phases and or Test Runs sharing a common objective.

Test Phase: A collection of one or more SPC-2C Test Runs sharing a common objective and intended to be run in a specific sequence.

Test Run: The execution of SPC-2C that produces specific SPC-2C test results. SPC-2C Test Runs have specified, measured Ramp-Up, Measurement Interval, Run-Out and Ramp-Down periods. "SPC-2C Test Run Components" (*see below*) illustrates the Ramp-Up, Steady State, Measurement Interval, Run-Out, and Ramp-Down components contained in two uninterrupted SPC-2C Test Runs (*Test Run 1: T_0 - T_5 and Test Run 2: T_5 - T_{10}*).

Test Run Sequence: A related sequence of Large File Processing (LFP) or Large Database Query (LDQ) Test Runs. Each Test Run Sequence will consist of five Test Runs, which vary the number of Streams as follows:

- Test Run 1: Maximum number of Streams, which is selected by the Test Sponsor
- Test Run 2: 50% of the maximum number of Streams used in Test Run 1.
- Test Run 3: 25% of the maximum number of Streams used in Test Run 1.
- Test Run 4: 12.5% of the maximum number of Streams used in Test Run 1.
- Test Run 5: 1 Stream.

Each of the five Test Runs in a Test Run Sequence will share the same attributes with the exception of the number of Streams. For example:

- Large File Processing, Read, 1024 KiB Transfer Size: Maximum Streams
- Large File Processing, Read, 1024 KiB Transfer Size: 50% of Maximum Streams
- Large File Processing, Read, 1024 KiB Transfer Size: 25% of Maximum Streams
- Large File Processing, Read, 1024 KiB Transfer Size: 12.5% of Maximum Streams
- Large File Processing, Read, 1024 KiB Transfer Size: 1 Stream

Transfer Size: The Transfer Size parameter specifies the number of bytes in KiB to transfer. (*Clause 3.4.7 of the SPC-2C Benchmark Specification*)

I/O Completion Types

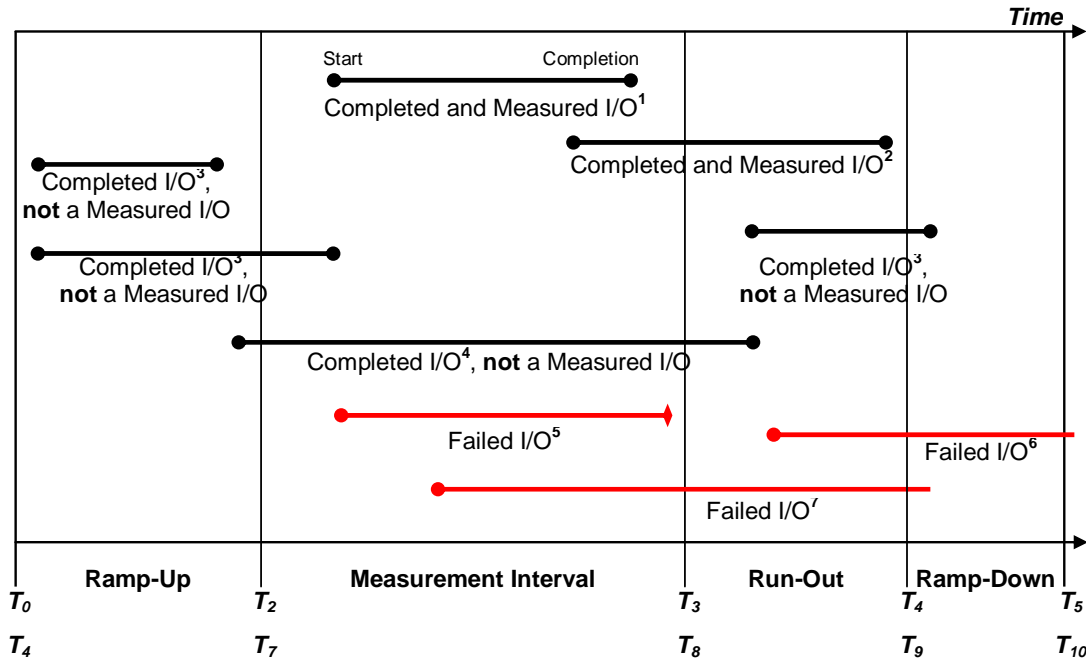

- Completed and Measured I/O¹:** I/O started and completed within the Measurement Interval.
- Completed and Measured I/O²:** I/O started within the Measurement Interval and completed within Ramp Down.
- Completed I/O³:** I/O started before or after the Measurement Interval – not measured.
- Completed I/O⁴:** I/O started before and completed after the Measurement Interval – not measured.
- Failed I/O⁵:** Signaled as failed by System Software.
- Failed I/O⁶:** I/O did not complete prior to the end of Ramp-Down.
- Failed I/O⁷:** I/O did not complete prior to the end of Run-Out.

SPC-2C Test Run Components

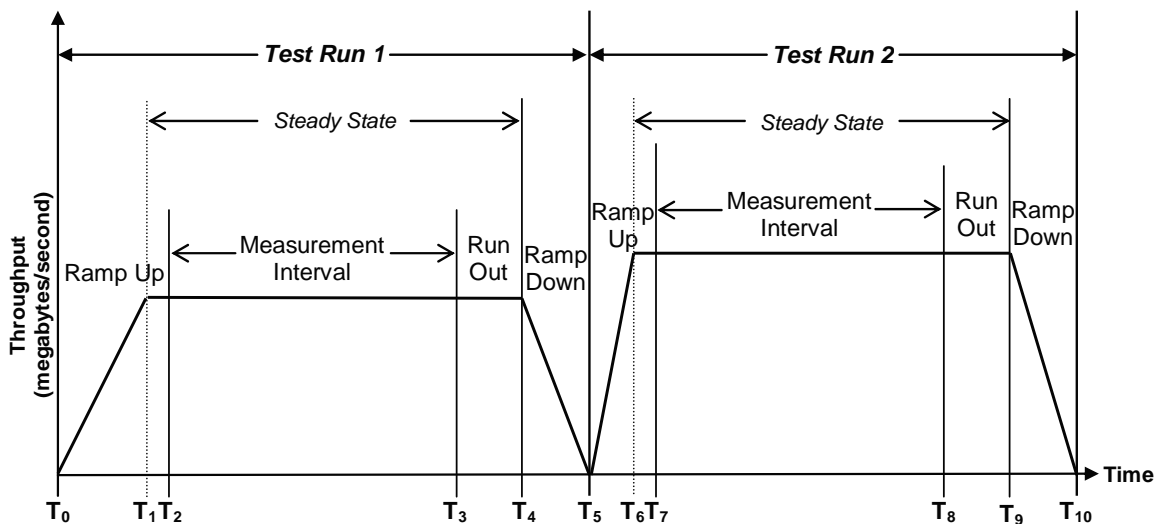

APPENDIX B: CUSTOMER TUNABLE PARAMETERS AND OPTIONS

The following LSI MegaCLI commands were used to change default values for the LSI MegaRAID SAS 8888ELP using the script listed below. This script is executed after successful completion of the steps documented in *Appendix C: Tested Storage Configuration (TSC) Creation*.

```
REM ***** Change Defaults *****
set adptr=0
Set BBU=CachedBadBBU
set access=RW
set DiskCache=-EnDskCache

MegaCLI -LDSetProp %BBU% -Lall -a%adptr%
MegaCLI -LDSetProp -%access% -Lall -a%adptr%
MegaCLI -LDSetProp %DiskCache% -Lall -a%adptr%
MegaCLI -LDSetProp -name one -L0 -a%adptr%
MegaCLI -LDSetProp -name two -L1 -a%adptr%
MegaCLI -LDSetProp -name three -L2 -a%adptr%
MegaCLI -LDSetProp -name four -L3 -a%adptr%
MegaCLI -LDSetProp -name five -L4 -a%adptr%
MegaCLI -LDSetProp -name six -L5 -a%adptr%
MegaCLI -LDSetProp -name seven -L6 -a%adptr%
MegaCLI -LDSetProp -name eight -L7 -a%adptr%
REM *****
```

Disk Enclosure Backplane Configuration

The default configuration for the AIX Xtore disk enclosure is that all twenty-four disks are attached to a single x4 SAS link. For maximum throughput, that default was changed to zone the enclosure into two banks of twelve disks each. After zoning, the first twelve slots, 0 – 11 will be connected to the Primary side of the enclosure, and the remaining twelve slots, 12 – 23 will be connected to the Secondary side of the enclosure.

To change the default configuration of the enclosure, perform the following steps. It is not necessary for the enclosure to be populated for this procedure, but it does have to be powered on. This reconfiguration may be executed either prior to or after the steps documented in *Appendix C: Tested Storage Configuration (TSC) Creation*.

- Attach to the COM port on the rear of Primary expander of the 24-drive disk enclosure
- Attach other end of the serial cable to the serial port on a computer on which a terminal emulator program is running
- In the terminal emulator window, enter the following commands to configure the Primary side of the enclosure:
 - **tZoneCfg -s 0-7 1**
 - **tZoneCfg -s 8-13 1**
 - **tZoneCfg -s 20-23 1**
 - **tZoneCfg -w**
 - **tZoneCfg -d**
- Attach to the COM port on the rear of Secondary expander of the 24-drive disk enclosure. In the terminal emulator window, enter the following commands to configure the Secondary side of the enclosure:
 - **tZoneCfg -s 0-13 2**

- *tZoneCfg -s 14-23 2*
- *tZoneCfg -w*
- *tZoneCfg -d*
- Power cycle the enclosure for zoning to take effect.
- Once the enclosure is zoned, settings are stored in non-volatile memory, so will persist through power cycles.

APPENDIX C: TESTED STORAGE CONFIGURATION (TSC) CREATION

Create RAID-5 Volumes

The MegaCLI utility can be used to create, delete, and manage RAID volumes through a command line interface. The utility is available on the LSI website at:

http://www.lsi.com/storage_home/products_home/internal RAID/megaraid_sas/megaraid_sas_8888elp/index.html

The following commands, embedded in script files, were used to create the RAID-5 volumes.

Clear RAID volumes

First, clear any RAID volumes that may be on the controller card.

```
REM *****Clear All RAID Volumes *****
MegaCLI -cfgclr -aALL
REM *****
```

Get disk list

Second, get a list all attached disks. Record the enclosure and slot numbers.

```
REM ***** Get Physical Disk Enclosure & Slot *****
MegaCLI -PDInfo -aALL
REM *****
```

Create the RAID-5 Volumes

Third, use the enclosure and slot numbers to modify the script below. Typically, the enclosure number is the same for all disks. "48" is used in this configuration. Typically the Slot numbers are adjacent integers.

```
REM ***** Create 8 RAID 5 Volumes *****
REM Span : NO
REM # HDD in Vol : 3
REM Phys HDD List : 0,1,2 etc
REM Spares : NO
REM Encryption : NO
REM RAID Level : 5
REM Stripe Size : 64 KB
REM LD Name : one,two,three,four,five
REM LD Read Policy : Adaptive Read Ahead
REM LD Write Policy : Write Back, Bad BBU
REM LD IO Policy : Direct IO
REM Access Policy : Read / Write
REM Disk Cache Policy : Enable
REM Initialization : Quick Init
REM *****

set adptr=0
set DriveList0=[48:0, 48:1, 48:2]
set DriveList1=[48:3, 48:4, 48:5]
set DriveList2=[48:6, 48:7, 48:8]
set DriveList3=[48:9, 48:10, 48:11]
set DriveList4=[48:12, 48:13, 48:14]
set DriveList5=[48:15, 48:16, 48:17]
set DriveList6=[48:18, 48:19, 48:20]
set DriveList7=[48:21, 48:22, 48:23]
set level=5
set stripe=64
set ReadCache=ADRA
set WriteCache=WB
Set BBU=CachedBadBBU
```

```
set IOpolicy=Direct
set access=RW
set DiskCache=-EnDskCache
set BI=-Dsbl

@echo on

REM ***** Create all Volumes *****
MegaCli -CfgLdAdd -r%level%DriveList0% %WriteCache% %ReadCache%
%IOpolicy% %BBU% -sz%stripe% -a%adptr%
MegaCli -CfgLdAdd -r%level%DriveList1% %WriteCache% %ReadCache%
%IOpolicy% %BBU% -sz%stripe% -a%adptr%
MegaCli -CfgLdAdd -r%level%DriveList2% %WriteCache% %ReadCache%
%IOpolicy% %BBU% -sz%stripe% -a%adptr%
MegaCli -CfgLdAdd -r%level%DriveList3% %WriteCache% %ReadCache%
%IOpolicy% %BBU% -sz%stripe% -a%adptr%
MegaCli -CfgLdAdd -r%level%DriveList4% %WriteCache% %ReadCache%
%IOpolicy% %BBU% -sz%stripe% -a%adptr%
MegaCli -CfgLdAdd -r%level%DriveList5% %WriteCache% %ReadCache%
%IOpolicy% %BBU% -sz%stripe% -a%adptr%
MegaCli -CfgLdAdd -r%level%DriveList6% %WriteCache% %ReadCache%
%IOpolicy% %BBU% -sz%stripe% -a%adptr%
MegaCli -CfgLdAdd -r%level%DriveList7% %WriteCache% %ReadCache%
%IOpolicy% %BBU% -sz%stripe% -a%adptr%
```

Configure SPC-2C Application Storage Unit (ASU)

The **size=35003** option, used in each SPC-2C parameter file, specified the capacity of each of the RAID-5 volumes. That capacity in each volume was concatenated by the SPC-2C Workload Generator to create the SPC-2C ASU.

Disable Volume Initialization

The controller will begin initialization upon the first I/O to each volume. Since the initial data stored on the new volumes is of no consequence for the benchmark measurements, volume initialization can be bypassed. The following MegaCLI commands will abort and disable initialization of all RAID volumes:

```
MegaCLI -LDBI -abort -Lall -aALL
MegaCLI -LDBI -dsbl -Lall -aALL
```

The commands may be executed from the command line of a DOS window and only need to be executed once during the initial configuration process.

APPENDIX D: SPC-2C WORKLOAD GENERATOR STORAGE COMMANDS AND PARAMETERS

Large File Processing Test (LFP)

```
* Large File Processing Test (LFP)
* host=localhost,spc2=\spc_component\spc-
  2C,jvms=5,maxstreams=10,java=C:\Java\bin\java
host=localhost,spc2=E:\SPC\SPC_C_Distribution\spc-2C,jvms=5,maxstreams=16

sd=default,host=localhost

sd=sd1,lun=\\.\\.\physicaldrive1,size=35003m
sd=sd2,lun=\\.\\.\physicaldrive2,size=35003m
sd=sd3,lun=\\.\\.\physicaldrive3,size=35003m
sd=sd4,lun=\\.\\.\physicaldrive4,size=35003m
sd=sd5,lun=\\.\\.\physicaldrive5,size=35003m
sd=sd6,lun=\\.\\.\physicaldrive6,size=35003m
sd=sd7,lun=\\.\\.\physicaldrive7,size=35003m
sd=sd8,lun=\\.\\.\physicaldrive8,size=35003m

maxlatestart=1
reportinginterval=5
segmentlength=512m

rd=default,rampup=180,periods=90,measurement=180,runout=45,rampdown=15,buffers=1

* LFP, "write" Test Phase

* Test Run Sequence 1
rd=default,rdpct=0,xfersize=1024k
rd=TR1-s5_SPC-2-FP,streams=10
rd=TR2-s4_SPC-2-FP,streams=5
rd=TR3-s3_SPC-2-FP,streams=3
rd=TR4-s2_SPC-2-FP,streams=2
rd=TR5-s1_SPC-2-FP,streams=1

* Test Run Sequence 2
rd=default,xfersize=256k
rd=TR6-s5_SPC-2-FP,streams=10
rd=TR7-s4_SPC-2-FP,streams=5
rd=TR8-s3_SPC-2-FP,streams=3
rd=TR9-s2_SPC-2-FP,streams=2
rd=TR10-s1_SPC-2-FP,streams=1

* LFP, "read-write" Test Phase

* Test Run Sequence 3
rd=default,rdpct=50,xfersize=1024k
rd=TR11-s5_SPC-2-FP,streams=10
rd=TR12-s4_SPC-2-FP,streams=5
rd=TR13-s3_SPC-2-FP,streams=3
rd=TR14-s2_SPC-2-FP,streams=2
rd=TR15-s1_SPC-2-FP,streams=1

* Test Run Sequence 4
rd=default,xfersize=256k
rd=TR16-s5_SPC-2-FP,streams=10
rd=TR17-s4_SPC-2-FP,streams=5
rd=TR18-s3_SPC-2-FP,streams=3
```



```
rd=TR19-s2_SPC-2-FP,streams=2
rd=TR20-s1_SPC-2-FP,streams=1

* LFP, "read" Test Phase

* Test Run Sequence 5
rd=default,rdpct=100,xfersize=1024k
rd=TR21-s5_SPC-2-FP,streams=10
rd=TR22-s4_SPC-2-FP,streams=5
rd=TR23-s3_SPC-2-FP,streams=3
rd=TR24-s2_SPC-2-FP,streams=2
rd=TR25-s1_SPC-2-FP,streams=1

* Test Run Sequence 6
rd=default,xfersize=256k
rd=TR26-s5_SPC-2-FP,streams=10
rd=TR27-s4_SPC-2-FP,streams=5
rd=TR28-s3_SPC-2-FP,streams=3
rd=TR29-s2_SPC-2-FP,streams=2
rd=TR30-s1_SPC-2-FP,streams=1
```

Large Database Query Test (LDQ)

```
* Large Database Query Test (LDQ)
host=localhost,spc2=E:\SPC\SPC_C_Distribution\spc-2C,jvms=5,maxstreams=16

sd=default,host=localhost

sd=sd1,lun=\\.\\physicaldrive1,size=35003m
sd=sd2,lun=\\.\\physicaldrive2,size=35003m
sd=sd3,lun=\\.\\physicaldrive3,size=35003m
sd=sd4,lun=\\.\\physicaldrive4,size=35003m
sd=sd5,lun=\\.\\physicaldrive5,size=35003m
sd=sd6,lun=\\.\\physicaldrive6,size=35003m
sd=sd7,lun=\\.\\physicaldrive7,size=35003m
sd=sd8,lun=\\.\\physicaldrive8,size=35003m

maxlatestart=0
reportinginterval=5
segmentlength=512m

rd=default,rdpct=99,rampup=180,periods=90,measurement=180,runout=45,rampdown=15

* LDQ, 1024 KiB Test Phase

* Test Run Sequence 1
rd=default,xfersize=1024k,buffers=4
rd=TR1-s5_SPC-2-DQ,streams=10
rd=TR2-s4_SPC-2-DQ,streams=5
rd=TR3-s3_SPC-2-DQ,streams=3
rd=TR4-s2_SPC-2-DQ,streams=2
rd=TR5-s1_SPC-2-DQ,streams=1

* Test Run Sequence 2
rd=default,buffers=1
rd=TR6-s5_SPC-2-DQ,streams=10
rd=TR7-s6_SPC-2-DQ,streams=5
rd=TR8-s3_SPC-2-DQ,streams=3
rd=TR9-s2_SPC-2-DQ,streams=2
rd=TR10-s1_SPC-2-DQ,streams=1

* LDQ, 64 KiB Test Phase
```

```
* Test Run Sequence 3
rd=default,xfersize=64k,buffers=4
rd=TR11-s5_SPC-2-DQ,streams=10
rd=TR12-s6_SPC-2-DQ,streams=5
rd=TR13-s3_SPC-2-DQ,streams=3
rd=TR14-s2_SPC-2-DQ,streams=2
rd=TR15-s1_SPC-2-DQ,streams=1

* Test Run Sequence 4
rd=default,buffers=1
rd=TR16-s5_SPC-2-DQ,streams=10
rd=TR17-s4_SPC-2-DQ,streams=5
rd=TR18-s3_SPC-2-DQ,streams=3
rd=TR19-s2_SPC-2-DQ,streams=2
rd=TR20-s1_SPC-2-DQ,streams=1
```

Video on Demand Delivery Test (VOD)

```
* Video on Demand Test (VOD)

* host=localhost,spc2=\spc_component\spc-
  2C,jvms=5,maxstreams=1000,java=C:\Java\bin\java
host=localhost,spc2=E:\SPC\SPC_C_Distribution\spc-2C,jvms=5,maxstreams=700

sd=default,host=localhost

sd=sd1,lun=\\.\\.\physicaldrive1,size=35003m
sd=sd2,lun=\\.\\.\physicaldrive2,size=35003m
sd=sd3,lun=\\.\\.\physicaldrive3,size=35003m
sd=sd4,lun=\\.\\.\physicaldrive4,size=35003m
sd=sd5,lun=\\.\\.\physicaldrive5,size=35003m
sd=sd6,lun=\\.\\.\physicaldrive6,size=35003m
sd=sd7,lun=\\.\\.\physicaldrive7,size=35003m
sd=sd8,lun=\\.\\.\physicaldrive8,size=35003m

maxlatestart=0
videosegmentduration=1200
maxlatevod=0
reportinginterval=5

* rd=default,rampup=300,periods=180,measurement=280,runout=45,rampdown=15,buffers=8
rd=default,rampup=1200,periods=600,measurement=7200,runout=45,rampdown=15,buffers=8

rd=TR1-s255_SPC-2-VOD,streams=660
```

Persistence Test Run 1 (write phase)

```
* Persistence Test Run 1

* host=localhost,spc2=\spc_component\spc-
  2C,jvms=5,maxstreams=1000,java=C:\Java\bin\java
host=localhost,spc2=E:\SPC\SPC_C_Distribution\spc-2C,jvms=5,maxstreams=600

sd=default,host=localhost

sd=sd1,lun=\\.\\.\physicaldrive1,size=35003m
sd=sd2,lun=\\.\\.\physicaldrive2,size=35003m
sd=sd3,lun=\\.\\.\physicaldrive3,size=35003m
sd=sd4,lun=\\.\\.\physicaldrive4,size=35003m
sd=sd5,lun=\\.\\.\physicaldrive5,size=35003m
sd=sd6,lun=\\.\\.\physicaldrive6,size=35003m
```

```
sd=sd7,lun=\\.\\.\physicaldrive7,size=35003m
sd=sd8,lun=\\.\\.\physicaldrive8,size=35003m

maxlatestart=1
reportinginterval=5
segmentlength=512m

rd=default,rampup=180,periods=90,measurement=300,runout=0,rampdown=0,buffers=1

rd=default,rdpct=0,xfersize=1024k
rd=TR1-5s_SPC-2-persist-w,streams=10
```

Persistence Test Run 2 (read phase)

```
* Persistence Test Run 2

* host=localhost,spc2=\spc_component\spc-
  2C,jvms=5,maxstreams=1000,java=C:\Java\bin\java
host=localhost,spc2=E:\SPC\SPC_C_Distribution\spc-2C,jvms=5,maxstreams=600

sd=default,host=localhost

sd=sd1,lun=\\.\\.\physicaldrive1,size=35003m
sd=sd2,lun=\\.\\.\physicaldrive2,size=35003m
sd=sd3,lun=\\.\\.\physicaldrive3,size=35003m
sd=sd4,lun=\\.\\.\physicaldrive4,size=35003m
sd=sd5,lun=\\.\\.\physicaldrive5,size=35003m
sd=sd6,lun=\\.\\.\physicaldrive6,size=35003m
sd=sd7,lun=\\.\\.\physicaldrive7,size=35003m
sd=sd8,lun=\\.\\.\physicaldrive8,size=35003m

maxlatestart=1
reportinginterval=5
segmentlength=512m

maxpersistenceerrors=10

rd=default,buffers=1,rdpct=100,xfersize=1024k
rd=TR1-5s_SPC-2-persist-r
```

APPENDIX E: SPC-2C WORKLOAD GENERATOR EXECUTION COMMANDS AND PARAMETERS

Video on Demand Delivery, Large File Processing Test, Large Database Query Tests, and Persistence Test Run 1

```
REM *****
REM Run 5 tests:
REM   VOD                spc2_24.vod
REM   LFP                spc2_24.lfp
REM   LDQ                spc2_24.ldq
REM   Persistence 1     spc2-per1_24.txt
REM   <<< reboot >>>
REM   Persistence 2     spc2-per2_24.txt
REM
REM   spc2-full_24.bat  runs VOD, LFP, LDQ, PER1
REM   <<< reboot >>>
REM   spc2-per2_24.bat  runs PER2
REM *****

@echo on
REM sleep 600

set dir=%~dp0
set cp=%~dp0
set java=java

java -Xmx1024m -Xms1024m -Xss124k -cp %cp% vdbench -f spc2_24.vod -o
LSI_8888ELP_24_vod
java -Xmx1024m -Xms1024m -Xss124k -cp %cp% vdbench -f spc2_24.lfp -o
LSI_8888ELP_24_lfp
java -Xmx1024m -Xms1024m -Xss124k -cp %cp% vdbench -f spc2_24.ldq -o
LSI_8888ELP_24_ldq
java -Xmx1024m -Xms1024m -Xss124k -cp %cp% vdbench -f spc2-per1_24.txt -o
LSI_8888ELP_24_PER1
rem java -Xmx1024m -Xms1024m -Xss124k -cp %cp% vdbench -f spc2-per2_24.txt -o
LSI_8888ELP_24_PER2
```

Persistence Test Run 2

```
REM *****
REM Run 5 tests:
REM   VOD                spc2_15.vod
REM   LFP                spc2_15.lfp
REM   LDQ                spc2_15.ldq
REM   Persistence 1     spc2-per1_15.txt
REM   <<< reboot >>>
REM   Persistence 2     spc2-per2_15.txt
REM
REM   spc2-full_15.bat  runs VOD, LFP, LDQ, PER1
REM   <<< reboot >>>
REM   spc2-per2_15.bat  runs PER2
REM *****

@echo on
REM sleep 600

set dir=%~dp0
set cp=%~dp0
```

```
set java=java
```

```
java -Xmx1024m -Xms1024m -Xss124k -cp %cp% vdbench -f spc2-per2_24.txt -o  
LSI_8888ELP_24_PER2
```

APPENDIX F: THIRD-PARTY QUOTES

LSI MegaRAID SAS 8888ELP

The screenshot shows the Newegg.com product page for the LSI LSI00142 MegaRAID SAS 8888ELP. The page includes a search bar, navigation menu, and breadcrumb trail: Home > Categories > Hard Drives > Controllers / RAID Cards > LSI > Item#:N02E10016110089. The product title is "LSI LSI00142 x8 lane PCI Express 1.0a compliant PCI Power Management Specification 1.1 compliant SATA / SAS MegaRAID SAS 8888ELP Kit RAID levels 0, 1, 5, and 6 RAID spans 10, 50 and 60 - Retail SAS 8-E 8-1 PT RAID 0/1/5/6/10/50 PCI-E". The price is \$789.99 with 3 Business Day Shipping for \$8.25. The product is in stock. The specifications table is as follows:

CUSTOMER REVIEWS		SPECIFICATIONS	
Model			
Brand	LSI		
Model	LSI00142		
Specifications			
Type	SATA / SAS		
External Ports	Two SAS SFF8088 x4 external connectors		
Internal Connectors	Two SAS SFF8087 x4 internal connectors		
Interface	x8 lane PCI Express 1.0a compliant PCI Power Management Specification 1.1 compliant		
Transfer Rate	Up to 3Gb/s per port		
RAID	RAID levels 0, 1, 5, and 6 RAID spans 10, 50 and 60		
Dimensions	7.7" x 2.5"		
Features			
Features	Auto-resume on array rebuild Auto resume array reconstruction Online Capacity Expansion (OCE) RAID Level Migration (RLM)) Create 64 logical volumes Up to 64TB LUN support Comprehensive management tools LED fault indicator header Audible alarm circuit		
Packaging			
Package Contents	LSI00142 Quick Installation Guide Resource Disk SAS Cable Low-profile Bracket		

Seagate Savvio™ 15K, 36 GB SAS Disk Drives

Home | [Customer Service](#) | [About Us](#) | [Contact Us](#) 0 Items In Cart [View Cart](#) | [My Account](#)

Global Micro Enter Keyword or Part Number

[Controller Cards](#) | [CPU](#) | [Electronics](#) | [Mass Storage](#) | [Memory](#) | [Misc.](#) | [Networking](#) | [Printers & Acces.](#) | [RAID Solutions](#) | [Servers](#) | [Video Cards](#)

Manufacturers
Please Select

36GB 15K HD SAS SFF 2.5LP 11IN HPL DP
[ST936751SS] - NEW **\$276.00**
In Stock

[Click to enlarge](#)

[Controller Cards](#) | [CPU](#) | [Electronics](#) | [Mass Storage](#) | [Memory](#) | [Misc.](#) | [Networking](#) | [Printers & Acces.](#) |

Copyright © 2008. All rights reserved.

Powered by osCommerce and [BWS](#) [Privacy Notice](#) | [Terms Of Service](#) | [Shipping & Returns](#)

AIC XJ SA26-224R Disk Enclosure



0
0
0
0

**LSI Logic Corporation
Sales Quote# 4227527
Created By: Jackie Fuentes**

Bill To: LSI Logic Corporation
Attn: Accounts Payable
MS LSI AP
4420 Arrowswest Dr.
Colorado Springs, CO 80907

Ship To: LSI Logic Corporation
Attn: Bob Frizzell
47668 Kato Road
FREMONT, CA 94538

Ship-Via		Member Reference		Project	Cost Center
UPS Ground					
PO Number	Date	Sales Person		Terms	Num
frizzell1117a	2008-11-17	Jerry Morin - 708-799-0582 - TeamJerry@moredirect.com		Net30	4227527

Quote Items					
Qty	Mfg Part #	Description	Manufacturer	Unit Price	Extended
1	XJ-SA26-224R-B	SAS JBOD 2U 24-BAY 2.5DRIVE D UAL EXP BLK(XJ-SA26-224R-B)	AIC	\$2,087.14	\$2,087.14
Total (Product Only):					\$2,087.14

* Pricing and availability are subject to change
* Prices do not include tax or shipping

Signature Date

Print Name

MoreDirect, Inc.
4800 T-Rex Ave., Suite 300
Boca Raton, Florida 33431
Tel. (561) 237-3300.

External SAS Cables



SEARCH OUR INVENTORY:

3 character minimum

Home
New Products
Custom Requests
EX4-10Gb Ethernet Cables
Emulation
Fiber Optic Cables
Fibre Channel
Infiniband Cables
Mini-SAS (iPass)
Optical Transceivers
PCIe (PCI Express) Cables
SAS Products
SATA Products
SCSI Cables
Special Adapters
USB

CONTACT INFO **ABOUT US** **VIEW CART** **CHECK OUT**
 Email: Password:
 Forgot password?

Mini-SAS Cables

[Mini-SAS \(iPass\)](#) => [Mini-SAS Cables](#)

SA-8888-1m

Part #:	SA-8888-1m
Description:	MiniSAS (SFF-8088) - MiniSAS (SFF-8088), 1 meter
Minimum Quantity:	1
List Price:	\$48.00
Wiring Diagrams:	WB

For Corporate or Volume Pricing, call 303-810-5110

Mini SAS (*iSAS*) is the newest generation of Serial Attached SCSI (SAS) cables. The smaller connector design and positive locking save space and insure reliable connections. This line of cables is ready for the jump to 6Gb/s planned for 2007.

SERIAL CABLES is pleased to announce our new *Mini SAS* series of Cables to meet the requirements of the new Mini SAS specifications from the SCSI T-10 committee. The two primary connectors in *Mini SAS* are the 26-CKT External connector and the 36-CKT Internal connector that can also carry Sideband signals if they are used.

In the Marketplace for SAS and SATA products, there has been considerable confusion in the use of the terms "straight-through" and "crossover" cables. To alleviate this confusion Serial Cables uses part numbers and descriptions that more clearly indicate the use of each cable.

Our Part numbering is simple to understand. The last two numbers of the specified connector type (Example: SFF-8088, this cable connector would be represented as an 88 in the part number). Also, the first two number indicate the "Host Side" and the second two number indicate the "Target Side" and lastly the length in meters. Simply mouse over any specified part number/description in the table below and get a visual of the cable connector ends for the part number you are selecting.