



**SPC BENCHMARK 1™
FULL DISCLOSURE REPORT**

**DATA CORE SOFTWARE CORPORATION
DATA CORE SANMELODY™ DISK SERVER**

SPC-1 V1.8

Submitted for Review: April 12, 2004

Submission Identifier: A00029

Accepted: June 11, 2004



First Edition – April 2004

THE INFORMATION CONTAINED IN THIS DOCUMENT IS DISTRIBUTED ON AN AS IS BASIS WITHOUT ANY WARRANTY EITHER EXPRESS OR IMPLIED. The use of this information or the implementation of any of these techniques is the customer's responsibility and depends on the customer's ability to evaluate and integrate them into the customer's operational environment. While each item has been reviewed by DataCore Software Corporation for accuracy in a specific situation, there is no guarantee that the same or similar results will be obtained elsewhere. Customers attempting to adapt these techniques to their own environment do so at their own risk.

This publication was produced in the United States. DataCore Software Corporation may not offer the products, services, or features discussed in this document in other countries, and the information is subject to change with notice. Consult your local DataCore Software Corporation representative for information on products and services available in your area.

© Copyright DataCore Software Corporation 2004. All rights reserved.

Permission is hereby granted to reproduce this document in whole or in part, provided the copyright notice as printed above is set forth in full text on the title page of each item reproduced.

Trademarks

SPC Benchmark 1, SPC-1 IOPS, and SPC-1 LRT are trademarks of the Storage Performance Council. DataCore, the DataCore logo, and SANmelody are trademarks or registered trademarks of DataCore Software Corporation in the United States and other countries. All other brands, trademarks, and product names are the property of their respective owners.

Notes

The following terms, used in this document, are defined as:

- Kilobyte (KB) is equal to 1,000 (10^3) bytes.
- Megabyte (MB) is equal to 1,000,000 (10^6) bytes.
- Gigabyte (GB) is equal to 1,000,000,000 (10^9) bytes.
- Terabyte (TB) is equal to 1,000,000,000,000 (10^{12}) bytes.

Table of Contents

Audit Certification	vi
Letter of Good Faith	viii
Executive Summary	9
Test Sponsor and Contact Information	9
Revision Information and Key Dates	9
Summary of Results	10
Storage Capacities and Relationships	10
Response Time – Throughput Curve	11
Response Time – Throughput Data	11
Tested Storage Configuration Pricing (<i>Priced Storage Configuration</i>)	12
Differences between the Tested Storage Configuration (TSC) and Priced Storage Configuration	12
Benchmark Configuration/Tested Storage Configuration Diagram 1	13
Benchmark Configuration/Tested Storage Configuration Diagram 2	14
Benchmark Configuration/Tested Storage Configuration Details	15
Configuration Information	16
Benchmark Configuration (BC)/Tested Storage Configuration (TSC) Diagram	16
Storage Network Configuration	16
Host System Configuration	16
Customer Tunable Parameters and Options	17
Tested Storage Configuration (TSC) Description	17
SPC-1 Workload Generator Storage Configuration	17
Data Repository	18
Definitions	18
Storage Capacities and Relationships	19
SPC-1 Storage Capacities	19
SPC-1 Storage Capacities and Relationships Illustration	19
SPC-1 Storage Hierarchy Ratios	20
Logical Volume Capacity and ASU Mapping	20
SPC-1 Benchmark Execution Results	21
Definitions	21
Primary Metrics Test – Sustainability Test Phase	22
SPC-1 Workload Generator Input Parameters	22
Sustainability Test Results File	22
Sustainability – Data Rate Distribution Data (<i>MB/second</i>).....	23
Sustainability – Data Rate Distribution Graph	24

Sustainability – I/O Request Throughput Distribution Data	25
Sustainability – I/O Request Throughput Distribution Graph	26
Sustainability – Measured Intensity Multiplier and Coefficient of Variation.....	26
Primary Metrics Test – IOPS Test Phase.....	27
SPC-1 Workload Generator Input Parameters	27
IOPS Test Results File.....	27
IOPS Test Run – I/O Request Throughput Distribution Data	28
IOPS Test Run – I/O Request Throughput Distribution Graph.....	28
IOPS Test Run – Response Time Frequency Distribution Data	29
IOPS Test Run –Response Time Frequency Distribution Graph.....	29
IOPS Test Run – Average Response Time (ms) Distribution Data	30
IOPS Test Run – Average Response Time (ms) Distribution Graph	30
IOPS Test Run – I/O Request Information.....	31
IOPS Test Run – Measured Intensity Multiplier and Coefficient of Variation	31
Primary Metrics Test – Response Time Ramp Test Phase	32
SPC-1 Workload Generator Input Parameters	32
Response Time Ramp Test Results File.....	32
Response Time Ramp Distribution (IOPS) Data.....	33
Response Time Ramp Distribution (IOPS) Graph	33
Response Time Ramp Distribution (IOPS) Graph	34
SPC-1 LRT™ Average Response Time (ms) Distribution Data.....	35
SPC-1 LRT™ Average Response Time (ms) Distribution Graph	35
SPC-1 LRT™ (10%) – Measured Intensity Multiplier and Coefficient of Variation	36
Repeatability Test	37
SPC-1 Workload Generator Input Parameters	37
Repeatability Test Results File	38
Repeatability 1 LRT – I/O Request Throughput Distribution Data.....	39
Repeatability 1 LRT – I/O Request Throughput Distribution Graph	39
Repeatability 1 LRT –Average Response Time (ms) Distribution Data	40
Repeatability 1 LRT –Average Response Time (ms) Distribution Graph.....	40
Repeatability 1 IOPS – I/O Request Throughput Distribution Data	41
Repeatability 1 IOPS – I/O Request Throughput Distribution Graph.....	41
Repeatability 1 IOPS –Average Response Time (ms) Distribution Data	42
Repeatability 1 IOPS –Average Response Time (ms) Distribution Graph	42
Repeatability 2 LRT – I/O Request Throughput Distribution Data.....	43
Repeatability 2 LRT – I/O Request Throughput Distribution Graph	43
Repeatability 2 LRT –Average Response Time (ms) Distribution Data	44
Repeatability 2 LRT –Average Response Time (ms) Distribution Graph.....	44
Repeatability 2 IOPS – I/O Request Throughput Distribution Data	45

Repeatability 2 IOPS – I/O Request Throughput Distribution Graph.....	45
Repeatability 2 IOPS –Average Response Time (ms) Distribution Data.....	46
Repeatability 2 IOPS –Average Response Time (ms) Distribution Graph	46
Repeatability 1 (LRT) Measured Intensity Multiplier and Coefficient of Variation.....	47
Repeatability 1 (IOPS) Measured Intensity Multiplier and Coefficient of Variation	47
Repeatability 2 (LRT) Measured Intensity Multiplier and Coefficient of Variation	47
Repeatability 2 (IOPS) Measured Intensity Multiplier and Coefficient of Variation	47
Data Persistence Test.....	48
SPC-1 Workload Generator Input Parameters	48
Data Persistence Test Results File	48
Data Persistence Test Results.....	49
Priced Storage Configuration Availability Date.....	50
Pricing Information.....	50
Anomalies or Irregularities	50
Appendix A: Customer Tunable Parameters and Options.....	51
Appendix B: Tested Storage Configuration (TSC) Creation	53
Storage Pool Creation	53
Pre-Allocated Logical Volume Creation	54
Storage Server – Logical Volume Availability.....	54
Storage Server – Logical Volume Availability.....	55
Virtual Volume Creation	56
Appendix C: SPC-1 Workload Generator Storage Commands and Parameters	57
Appendix D: Third-Party Price Quotations	58
SC-1 – SANmelody™ Disk Server system:.....	58
HS-1 and 2 –Host Systems:.....	59
Qlogic QLA2344 HBAs:	60
Qlogic QLA2342 HBA:	60
Qlogic QLA2340 HBA:	61
JMR 10Bay Fibre Channel Chassis:	62
Seagate ST318453FC 18.4 GB 15K RPM Disk Drive:.....	63
Seagate ST336753FCO 36.7 GB 15K RPM Disk Drive:.....	64
Fibre Media Interface Adaptor:	65
LC to LC Multimode Duplex Fiber Optic Patch Cables:	66
SC to LC Multimode Duplex Fiber Optic Patch Cables:	67

AUDIT CERTIFICATION



Augie Gonzalez
DataCore Software Corporation
6300 NW 5th Way
Fort Lauderdale, FL 33309

April 12, 2004

The SPC Benchmark 1™ results listed below for the DataCore SANmelody™ Disk Server were produced in compliance with the SPC Benchmark 1™ V1.8 Onsite Audit requirements.

SPC Benchmark 1™ V1.8 Results	
Tested Storage Configuration (TSC) Name:	
DataCore SANmelody™ Disk Server	
Metric	Reported Result
SPC-1 IOPS™	19,949.73
SPC-1 Price-Performance	\$4.06/SPC-1 IOPS™
Total ASU Capacity	407.018 GB
Data Protection Level	Mirroring
Total TSC Price (including three-year maintenance)	\$80,897.00

The following SPC Benchmark 1™ Onsite Audit requirements were reviewed and found compliant with V1.8 of the SPC Benchmark 1™ specification:

- A Letter of Good Faith, signed by a senior executive.
- The following Data Repository storage items were verified by physical inspection and information supplied by DataCore Software Corporation:
 - ✓ Physical Storage Capacity and requirements.
 - ✓ Configured Storage Capacity and requirements.
 - ✓ Addressable Storage Capacity and requirements.
 - ✓ Capacity of each Logical Volume and requirements.
 - ✓ Capacity of each Application Storage Unit (ASU) and requirements.
- An appropriate diagram of the Benchmark Configuration (BC)/Tested Storage Configuration (TSC).
- Physical verification of the components to match the above diagram.

Storage Performance Council
643 Bair Island Road, Suite 103
Redwood City, CA 94062
AuditService@storageperformance.org
650.556.9384

- Listings and commands to configure the Benchmark Configuration/Tested Storage Configuration, including customer tunable parameters.
- Commands and parameters used to configure the SPC-1 Workload Generator.
- The following Host System requirements were verified by physical inspection and information supplied by DataCore Software Corporation:
 - ✓ The type of Host System including the number of processors and main memory.
 - ✓ The presence and version number of the Workload Generator on the Host System.
 - ✓ The TSC boundary within the Host System.
- The execution of Test, Test Phase, and Test Run was observed and found compliant with all of the requirements and constraints of Clauses 4 and 5 of the SPC-1 Benchmark Specification.
- The Test Results Files and resultant Summary Results Files received for each of following were authentic, accurate, and compliant with all of the requirements and constraints of Clauses 4 and 5 of the SPC-1 Benchmark Specification:
 - ✓ Data Persistence Test
 - ✓ Sustainability Test Phase
 - ✓ IOPS Test Phase
 - ✓ Response Time Ramp Test Phase
 - ✓ Repeatability Test
- There were no differences between the Tested Storage Configuration (TSC) used for the benchmark and Priced Storage Configuration.
- The final version of the pricing spreadsheet met all of the requirements and constraints of Clause 8 of the SPC-1 Benchmark Specification.
- The Full Disclosure Report (FDR) met all of the requirements in Clause 9 of the SPC-1 Benchmark Specification.

Audit Notes:

There were no additional audit notes or exceptions.

Respectfully,

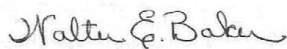

Walter E. Baker
SPC Auditor

Storage Performance Council
643 Bair Island Road, Suite 103
Redwood City, CA 94062
AuditService@storageperformance.org
650.556.9384

LETTER OF GOOD FAITH



Date: April 2, 2004

From: Ziya Aral, Chief Technology Officer, DataCore Software

To: Walter Baker, SPC Auditor, Gradient Systems

Subject: SPC-1 Letter of Good Faith for the SANmelodySPC-1™ configuration

DataCore Software is the SPC-1 Test Sponsor for the above listed product. To the best of our knowledge and belief, the required SPC-1 benchmark results and materials we have submitted for that product are complete, accurate, and in full compliance with V1.8 of the SPC-1 benchmark specification.

In addition, we have reported any items in the Benchmark Configuration and execution of the benchmark that affected the reported results even if the items are not explicitly required to be disclosed by the SPC-1 benchmark specification.

Signed:

Date: April 8, 2004

A handwritten signature in black ink, appearing to read 'Ziya A. Aral'.

Ziya Aral,
Chief Technology Officer,
DataCore Software

EXECUTIVE SUMMARY**Test Sponsor and Contact Information**

Test Sponsor and Contact Information	
Test Sponsor Primary Contact	DataCore Software Corporation – www.datacore.com Augie Gonzalez – augie.gonzalez@datacore.com 6300 NW 5 th Way Fort Lauderdale, FL 33309 Phone: (954) 377-6000 FAX: (954) 938-7953
Test Sponsor Alternate Contact	DataCore Software Corporation – www.datacore.com Roni Putra – roni.putra@datacore.com 6300 NW 5 th Way Fort Lauderdale, FL 33309 Phone: (954) 377-6000 FAX: (954) 938-7953
Auditor	Storage Performance Council – www.storageperformance.org Walter E. Baker – AuditService@storageperformance.org 643 Bair Island Road, Suite 103 Redwood City, CA 94063 Phone: (650) 556-9384 FAX: (650) 556-9385

Revision Information and Key Dates

Revision Information and Key Dates	
SPC-1 Specification revision number	V1.8
SPC-1 Workload Generator revision number	V2.00.04a
Date Results were first used publicly	April 12, 2004
Date FDR was submitted to the SPC	April 12, 2004
Date the TSC is/was available for shipment to customers	March 8, 2004
Date the TSC completed audit certification	April 9, 2004

Summary of Results

SPC-1 Results	
Tested Storage Configuration (TSC) Name: DataCore SANmelody™ Disk Server	
Metric	Reported Result
SPC-1 IOPS™	19,949.73
SPC-1 Price-Performance	\$4.06/SPC-1 IOPS™
Total ASU Capacity	407.018 GB
Data Protection Level	Mirroring
Total TSC Price (including three-year maintenance)	\$80,897.00

SPC-1 IOPS™ represents the maximum I/O Request Throughput at the 100% load point.

Total ASU (Application Storage Unit) Capacity represents the total storage capacity read and written in the course of executing the SPC-1 benchmark.

A Data Protection Level of Mirroring configures two or more identical copies of user data. Mirroring for this SPC-1 result was implemented by Host System software (Microsoft Windows) and as a result the two Host Systems were included as components in the Tested Storage Configuration (TSC) as well as the Priced Storage Configuration.

Storage Capacities and Relationships

The following diagram documents the various storage capacities, used in this benchmark, and their relationships.

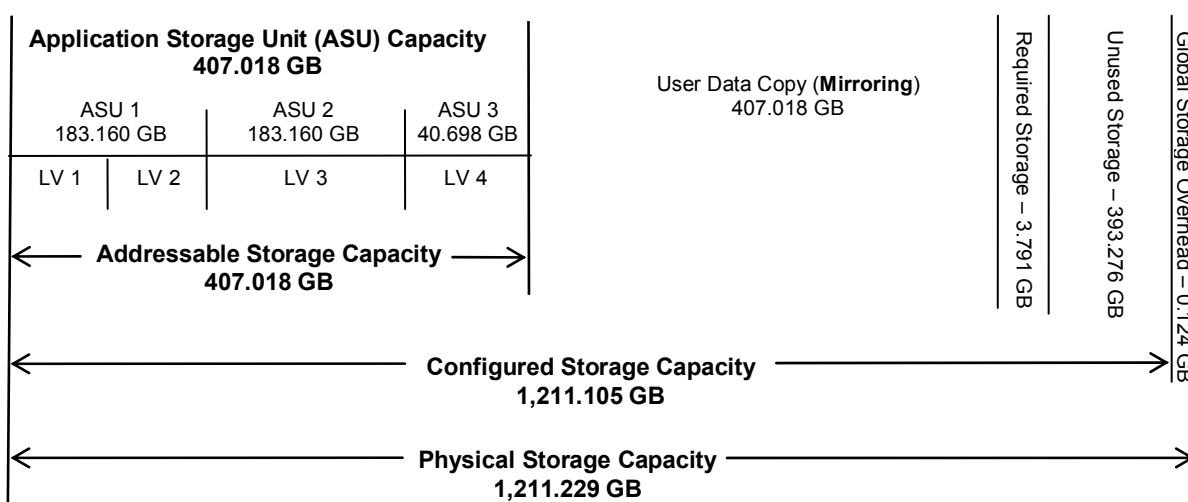

Response Time – Throughput Curve

The Response Time-Throughput Curve illustrates the Average Response Time (milliseconds) and I/O Request Throughput at 100%, 95%, 90%, 80%, 50%, and 10% of the workload level used to generate the SPC-1 IOPS™ metric.

The Average Response Time measured at any of the above load points cannot exceed 30 milliseconds or the benchmark measurement is invalid.

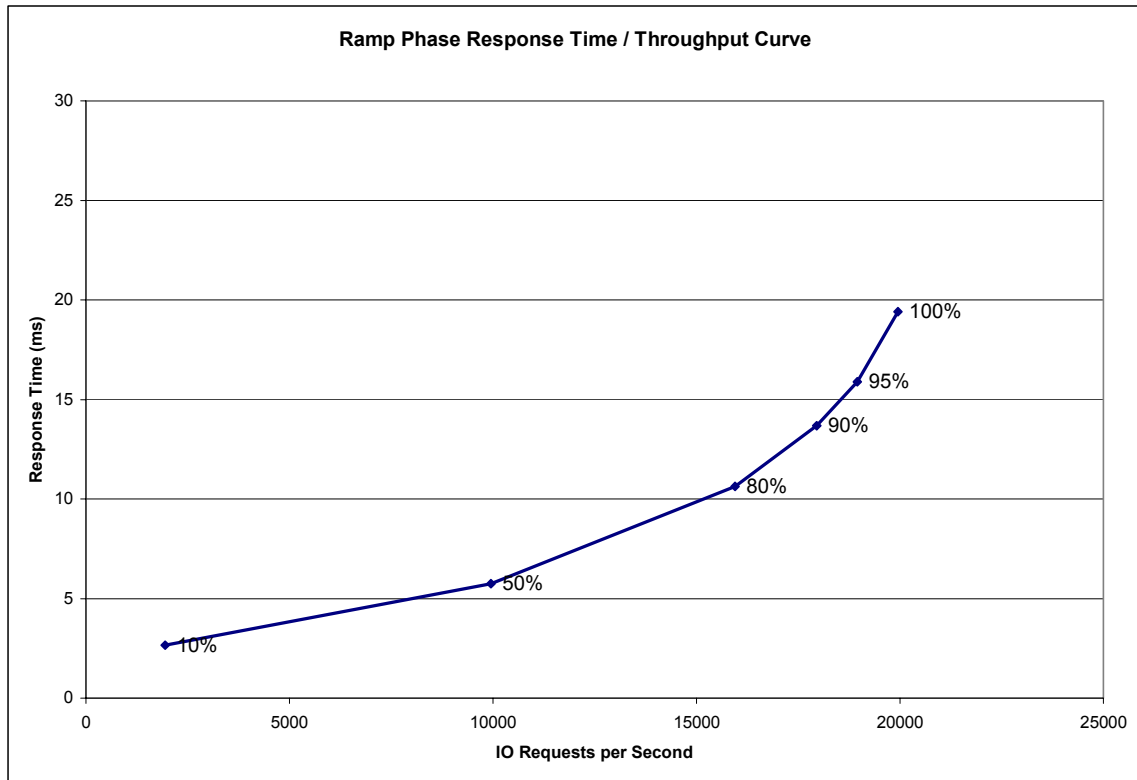

Response Time – Throughput Data

	10% Load	50% Load	80% Load	90% Load	95% Load	100% Load
I/O Request Throughput	1,950.26	9,951.10	15,950.63	17,950.99	18,951.79	19,949.73
Average Response Time (ms):						
All ASUs	2.65	5.75	10.63	13.69	15.90	19.40
ASU-1	3.63	7.85	15.23	19.61	22.35	27.21
ASU-2	2.83	7.12	10.20	13.12	15.65	18.55
ASU-3	0.50	0.72	1.06	1.37	2.32	3.21
Reads	6.08	13.69	25.63	33.03	37.82	45.72
Writes	0.42	0.59	0.86	1.09	1.61	2.26

Tested Storage Configuration Pricing (*Priced Storage Configuration*)

ITEM	SOFTWARE	Qty	Unit Price	Extended Price	Discount	Net Price
MDB-EWR-140-BSV	DataCore SANmelody™ Category D - Base Software	1	\$7,857	\$7,857	0%	\$7,857
MDP-EWR-140-FSV	DataCore SANmelody Auto Provisioning Option for Category D	1	\$3,928	\$3,928	0%	\$3,928
Software Subtotal						\$ 11,785
SERVERS (see 3rd party quotes)						
ITEM	SOFTWARE	Qty	Unit Price	Extended Price	Discount	Net Price
PowerEdge 2600	Dell PowerEdge 2600 Server, Dual Xeon 3.06GHZ CPU, 2GB DDR SDRAM (2x1GB) memory w/ Windows Server 2003 & 3 year Silver Support 4Hr Onsite [Disk Server]	1	\$ 5,374	\$ 5,374	7%	\$ 4,974
PowerEdge 2600	Dell PowerEdge 2600 Server, Dual Xeon 3.06GHZ CPU, 1GB DDR SDRAM (2x512MB) memory w/ Windows Server 2003 & 3 year Silver Support 4Hr Onsite [Host Systems]	2	\$ 4,824	\$ 9,648	8%	\$ 8,848
CHANNELS, DISKS & ENCLOSURES (see 3rd party quotes)						
QLA2344-CK	Qlogic Fibre Channel Quad, 4 SFF LC Multimode Optic	5	\$ 3,249	\$ 16,245	9%	\$ 14,795
QLA2342-CK	Qlogic Fibre Channel dual port HBA	1	\$ 1,575	\$ 1,575	5%	\$ 1,500
QLA2340-CK	Qlogic Fibre Channel single port HBA	1	\$ 925	\$ 925	0%	\$ 925
FR10-F22-2S	JMR JBOD 10 Bay, Fibre Channel, black Fortra Rackmountable	6	\$ 2,210	\$ 13,260	3%	\$ 12,810
ST318453FC	18.4GB Seagate Fibre Channel Disk, 15k rpm	46	\$ 210	\$ 9,660	10%	\$ 8,694
ST336753FCO	36GB Seagate Fibre Channel Disk, 15k rpm	10	\$ 255	\$ 2,550	0%	\$ 2,550
MDB-9-6-1	Fiber Media Interface Adaptor DB-9/SC (MIA Copper to Fiber)	7	\$ 230	\$ 1,610	0%	\$ 1,610
GCAZLL	LC:LC Fibre Multimode Duplex Fiber Optic Patch Cables, 5 meters, 62.5uM	8	\$ 51	\$ 408	20%	\$ 326
GCAZCL	SC:LC Fibre Multimode Duplex Fiber Optic Patch Cables, 5 meters, 62.5uM	7	\$ 40	\$ 283	20%	\$ 226
Servers, Channels, Disks & Enclosures Subtotal				\$ 61,538	7%	\$ 57,259
SM1-EWV-PLT-PY3	3- year S/W + H/W Maintenance (7x24x365 with 4hr response)					\$ 11,853
Total TSC Price (Including 3-year maintenance):						\$ 80,897

The following TSC components were priced using third-party price quotations:

- PowerEdge 2600 – SANmelody™ Disk Server system
- PowerEdge 2600 – SPC-1 Host Systems
- QLogic HBAs
- JMR JBOD 10 Bay Fibre Channel Chassis
- Disk drives
- Fibre Media Interface Adapters
- Cables

The third-party price quotations may be found in “Appendix D: Third-Party Price Quotations” on page 58.

Differences between the Tested Storage Configuration (TSC) and Priced Storage Configuration

There were no differences between the Tested Storage Configuration (TSC) and the Priced Storage Configuration.

Benchmark Configuration/Tested Storage Configuration Diagram 1

The first Benchmark Configuration (BC)/Tested Storage Configuration (TSC) diagram illustrates the complete configuration.

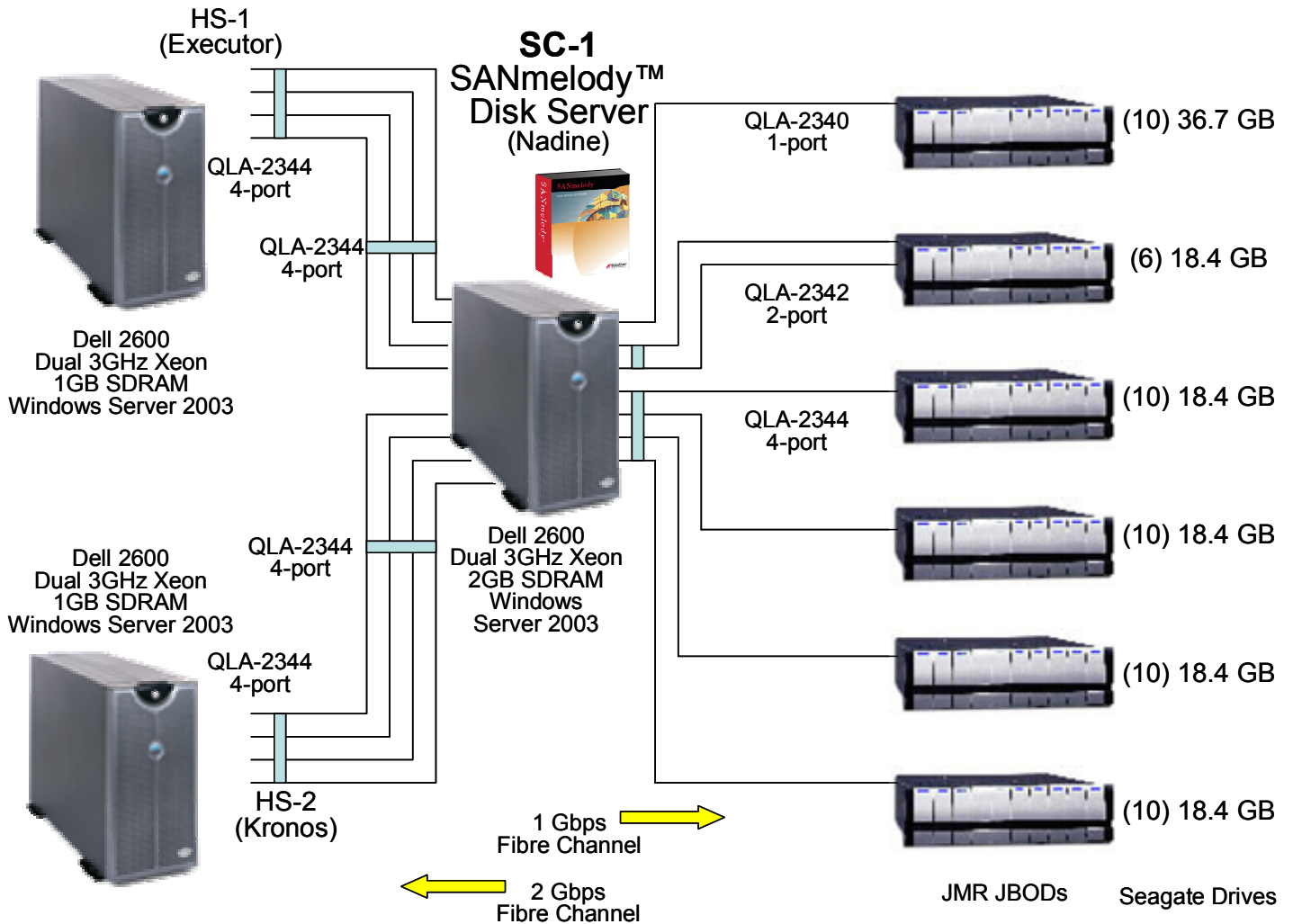

Benchmark Configuration/Tested Storage Configuration Diagram 2

The second Benchmark Configuration (BC)/Tested Storage Configuration (TSC) diagram illustrates the relationships between the ASUs, Host Systems, storage pools/disk drives, and data paths.

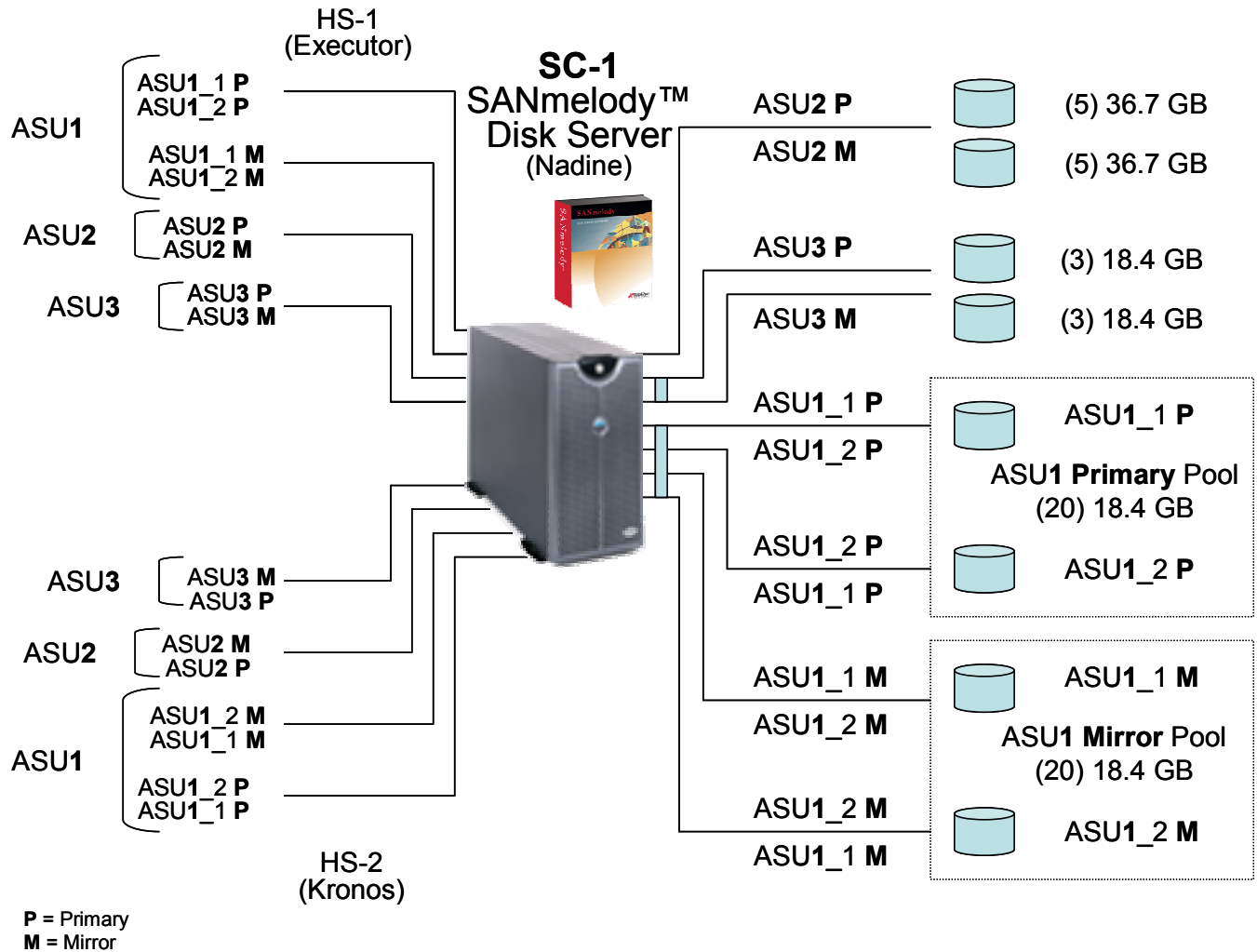

Benchmark Configuration/Tested Storage Configuration Details

Host Systems:	Tested Storage Configuration (TSC):
HS-1: Dell 2600	HS-1: Dell 2600
2 – Intel 3.0 GHz Xeon CPUs	HS-2: Dell 2600
512 KB L2 cache per CPU	SC-1: DataCore SANmelody™ Disk Server
1 GB main memory	Dell 2600 Server with:
1 – QLogic QLA-2344 4-port HBA	2 – Intel 3.0 GHz Xeon CPUs
Microsoft Windows Server™ 2003, Standard Edition	512 KB L2 cache per CPU
WG	2 GB main memory
HS-2: Dell 2600	3 – QLogic QLA-2344 4-port HBAs
2 – Intel 3.0 GHz Xeon CPUs	1 – QLogic QLA-2342 2-port HBA
512 KB L2 cache per CPU	1 – QLogic QLA-2340 1-port HBA
1 GB main memory	Microsoft Windows Server™ 2003, Standard Edition
1 – QLogic QLA-2344 4-port HBA	8 – 2 Gbps FC front-end ports
Microsoft Windows Server™ 2003, Standard Edition	7 – 1 Gbps FC backend ports
WG	6 – JMR JBOD 10 Bay Enclosures
	46 – 18.4 GB, 15k rpm Seagate disk drives
	10 – 36.7 GB, 15k rpm Seagate disk drives

CONFIGURATION INFORMATION

Benchmark Configuration (BC)/Tested Storage Configuration (TSC) Diagram

Clause 9.2.4.4.1

A one page Benchmark Configuration (BC)/Tested Storage Configuration (TSC) diagram shall be included in the Executive Summary...

The Benchmark Configuration (BC)/Tested Storage Configuration (TSC) is illustrated on page 13 (*Benchmark Configuration/Tested Storage Configuration Diagram*).

Storage Network Configuration

Clause 9.2.4.4.2

If a storage network is employed in the BC/TSC, the FDR shall contain a topology diagram... . This diagram should include, but is not limited to the following components:

- 1. Storage Controller and Domain Controllers (see Clause 9.2.4.4.1)*
- 2. Host Systems (see Clause 9.2.4.4.1)*
- 3. Routers and Bridges*
- 4. Hubs and Switches*
- 5. HBAs to Host Systems and Front End Port to Storage Controllers*

Additionally the diagram shall:

- Illustrate the physical connection between components.*
- Describe the type of each physical connection.*
- Describe the network protocol used over each physical connection.*
- The maximum theoretical transfer rate of each class of interconnect used in the configuration.*
- Correlate with the BC Configuration Diagram in Clause 9.2.4.4.1.*

The Test Sponsor shall additionally supply (referenced in an appendix) a wiring diagram of the physical connections and physical port assignments used in the storage network. The diagram should allow anyone to exactly replicate the physical configuration of the storage network.

The Benchmark Configuration (BC)/Tested Storage Configuration (TSC) was configured with local storage and, as such, did not employ a storage network.

Host System Configuration

Clause 9.2.4.4.3

The FDR shall minimally contain, for each Host System running the Workload Generator, a listing of the following:

- 1. Number and type of CPUs.*
- 2. Main memory capacity.*
- 3. Cache memory capacity.*
- 4. Number and type of disk controllers or Host Bus Adapters.*

The details of the Host System configuration may be found on page 13 (*Benchmark Configuration/Tested Storage Configuration Diagram*).

Customer Tunable Parameters and Options

Clause 9.2.4.5.1

All Benchmark Configuration (BC) components with customer tunable parameter and options that have been altered from their default values must be listed in the FDR. The FDR entry for each of those components must include both the name of the component and the altered value of the parameter or option.

“Appendix A: Customer Tunable Parameters and Options” on page 51 contains the customer tunable parameters and options that have been altered from their default values for this benchmark.

Tested Storage Configuration (TSC) Description

Clause 9.2.4.5.2

The FDR must include sufficient information to recreate the logical representation of the TSC. In addition to customer tunable parameters and options (Clause 4.2.4.5.3), that information must include, at a minimum, a diagram and/or description of the following:

- *All physical components that comprise the TSC. Those components are also illustrated in the Benchmark Configuration (BC) diagram in Clause 9.2.4.4.1 and, if applicable, the Storage Network Configuration Diagram in Clause 9.2.4.4.2.*
- *The logical representation of the TSC, configured from the above components that will be presented to the Workload Generator.*

In addition the FDR may include listings of scripts and/or commands used to configure the physical components that comprise the TSC.

“Appendix B: Tested Storage Configuration (TSC) Creation” on page 53 contains the detailed information that describes how to create and configure the logical TSC. Also included in that information is a description of the static physical storage allocation option (auto-provisioning), which was used to ensure all physical storage had been pre-allocated prior to the benchmark measurement and no subsequent physical storage allocation occurred during the benchmark measurement.

SPC-1 Workload Generator Storage Configuration

Clause 9.2.4.5.3

The FDR must include all SPC-1 Workload Generator storage configuration commands and parameters.

The SPC-1 Workload Generator storage configuration commands and parameters for this measurement appear in “Appendix B: ” on page 53.

DATA REPOSITORY

Definitions

Total ASU Capacity: The total storage capacity read and written in the course of executing the SPC-1 benchmark.

Application Storage Unit (ASU): The logical interface between the storage and SPC-1 Workload Generator. The three ASUs (Data, User, and Log) are typically implemented on one or more Logical Volume.

Logical Volume: The division of Addressable Storage Capacity into individually addressable logical units of storage used in the SPC-1 benchmark. Each Logical Volume is implemented as a single, contiguous address space.

Addressable Storage Capacity: The total storage (sum of Logical Volumes) that can be read and written by application programs such as the SPC-1 Workload Generator.

Configured Storage Capacity: This capacity includes the Addressable Storage Capacity and any other storage (parity disks, hot spares, etc.) necessary to implement the Addressable Storage Capacity.

Physical Storage Capacity: The formatted capacity of all storage devices physically present in the Tested Storage Configuration (TSC).

Data Protection Overhead: The storage capacity required to implement the ECC data protection.

Required Storage: The amount of Configured Storage Capacity required to implement the Addressable Storage Configuration, excluding the storage required for the three ASUs.

Global Storage Overhead: The amount of Physical Storage Capacity that is required for storage subsystem use and unavailable for use by application programs.

Total Unused Storage: The amount of storage capacity available for use by application programs but not included in the Total ASU Capacity.

Storage Capacities and Relationships

Two tables and an illustration documenting the storage capacities and relationships of the SPC-1 Storage Hierarchy (Clause 2.1) shall be included in the FDR.

SPC-1 Storage Capacities

SPC-1 Storage Capacities		
Storage Hierarchy Component	Units	Capacity
Total ASU Capacity	Gigabytes (GB)	407.018
Addressable Storage Capacity	Gigabytes (GB)	407.018
Configured Storage Capacity	Gigabytes (GB)	1,211.105
Physical Storage Capacity	Gigabytes (GB)	1,211.229
Data Protection Overhead (mirror)	Gigabytes (GB)	407.018
Required Storage	Gigabytes (GB)	3.791
Global Storage Overhead	Gigabytes (GB)	0.124
Total Unused Storage	Gigabytes (GB)	393.276

The Physical Storage Capacity consisted of 1,211.229 GB distributed over 46 disk drives each with a formatted capacity of 18.35197 GB plus 10 disk drives each with a formatted capacity of 36.70393 GB.

SPC-1 Storage Capacities and Relationships Illustration

The various storage capacities configured in the benchmark result are illustrated below (not to scale).

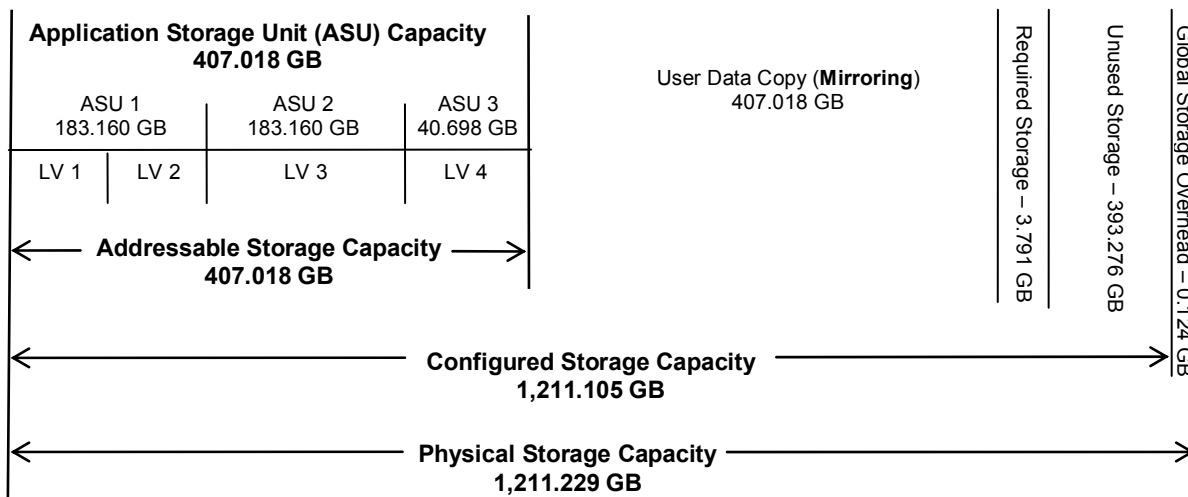

SPC-1 Storage Hierarchy Ratios

	Addressable Storage Capacity	Configured Storage Capacity	Physical Storage Capacity
Total ASU Capacity	100.00%	33.61%	33.60%
Required for Data Protection (Mirroring)		33.61%	33.60%
Addressable Storage Capacity		33.61%	33.60%
Required Storage		0.31%	0.31%
Configured Storage Capacity			99.99%
Global Storage Overhead			0.01%
Unused Storage	0.00%	32.47%	0.00%

Logical Volume Capacity and ASU Mapping

Clause 9.2.4.6.2

A table illustrating the capacity of each ASU and the mapping of Logical Volumes to ASUs shall be provided in the FDR. Logical Volumes shall be sequenced in the table from top to bottom per its position in the contiguous address space of each ASU. The capacity of each Logical Volume shall be stated. ... In conjunction with this table, the Test Sponsor shall provide a complete description of the type of data protection (see Clause 2.4.5) used on each Logical Volume.

Logical Volume Capacity and Mapping		
ASU-1 (183.1604 GB)	ASU-2 (183.1600 GB)	ASU-3 (40.6983 GB)
2 Logical Volume 91.5802 GB per Logical Volume (91.5802 GB used/Logical Volume)	1 Logical Volume 183.1600 GB per Logical Volume (183.1600GB used/Logical Volume)	1 Logical Volume 40.6983 GB per Logical Volume (40.6983 GB used/Logical Volume)

The Data Protection Level used for all Logical Volumes was Mirroring as described on page 10. See “ASU Configuration” in the [IOPS Test Results File](#) for more detailed configuration information.

SPC-1 BENCHMARK EXECUTION RESULTS

Definitions

Average Response Time: *The sum of the Response Times for all Measured I/O Requests divided by the total number of Measured I/O Requests.*

I/O Request Throughput: *The total number of Measured I/O requests in an SPC-1 Test Run divided by the duration of the Measurement Interval in seconds.*

Measurement Interval: *The finite and contiguous time period, after the Tested Storage Configuration (TSC) has reached Steady State, when data is collected by a Test Sponsor to generate an SPC-1 test result or support an SPC-1 test result.*

Steady State: *The consistent and sustainable throughput of the TSC. During this period the load presented to the TSC by the Workload Generator is constant. Comment: Steady Stated is achieved only after caches in the TSC have filled and as a result the I/O Request throughput of the TSC has stabilized.*

Test: *A collection of Test Phases or Test Runs sharing a common objective.*

Test Phase: *A collection of one or more SPC-1 Test Runs sharing a common objective and intended to be run in a specific sequence.*

Test Run: *The execution of SPC-1 for the purpose of producing or supporting an SPC-1 result. SPC-1 Test Runs may have a finite and measured Ramp-Up period, Start-Up period, Shut-Down period, and Ramp-Down period as illustrated in the Figure 5-1 below. All SPC-1 Test Runs shall have a Steady State period and a Measurement Interval.*

The SPC-1 benchmark consists of the following Tests, Test Phases, and Test Runs:

- **Data Persistence Test**
 - Data Persistence Test Run 1
 - Data Persistence Test Run 2
- **Primary Metrics Test**
 - Sustainability Test Phase and Test Run
 - IOPS Test Phase and Test Run
 - Response Time Ramp Test Phase
 - 95% of IOPS Test Run
 - 90% of IOPS Test Run
 - 80% of IOPS Test Run
 - 50% of IOPS Test Run
 - 10% of IOPS Test Run (LRT)
- **Repeatability Test**
 - Repeatability Test Phase 1
 - 10% of IOPS Test Run (LRT)
 - IOPS Test Run
 - Repeatability Test Phase 2
 - 10% of IOPS Test Run (LRT)
 - IOPS Test Run

Each Test is an atomic unit that must be executed from start to finish before any other Test, Test Phase, or Test Run may be executed. The Tests may be executed in any sequence.

The results from each Test, Test Phase, and Test Run are listed below along with a more detailed explanation of each component.

Primary Metrics Test – Sustainability Test Phase

Clause 5.4.2.1

The Sustainability Test Phase consists of one Test Run at the 100% load point with a Measurement Interval of three (3) hours. The intent is to demonstrate a sustained maximum I/O Request Throughput as well as insuring the Tested Storage Configuration (TSC) has reached steady state prior to measuring the maximum I/O Request Throughput (SPC-1™ IOPS).

The reported I/O Request Throughput of the Sustainability Test Run must be within 5% of the reported SPC-1™ IOPS primary metric. The Average Response Time measured in Sustainability Test Run cannot exceed thirty (30) milliseconds.

Clause 9.2.4.7.1

For the Sustainability Test Phase the FDR shall contain:

- 1. A Data Rate Distribution (data table and graph).*
- 2. I/O Request Throughput Distribution (data table and graph).*
- 3. The human readable Test Run Results File produced by the Workload Generator.*
- 4. A listing or screen image of all input parameters supplied to the Workload Generator.*
- 5. The Measured Intensity Multiplier for each I/O stream.*
- 6. The variability of the Measured Intensity Multiplier, as defined in Clause 5.3.13.3.*

SPC-1 Workload Generator Input Parameters

The following SPC-1 Workload Generator input parameters were used for the Sustainability, IOPS, and Response Time Ramp Test Runs :

java metrics –b 399 –r 780

Sustainability Test Results File

A link to the test results file generated from the Sustainability Test Run is listed below.

[Sustainability Test Results File](#)

Sustainability – Data Rate Distribution Data (MB/second)

Ramp-Up/Start-Up Start Stop Interval Duration
 Measurement Interval 7:58:45 8:01:45 0-2 0:03:00
 8:01:45 11:01:45 3-182 3:00:00

Interval	All ASUs	ASU1	ASU2	ASU3	Interval	All ASUs	ASU1	ASU2	ASU3	Interval	All ASUs	ASU1	ASU2	ASU3
0	163.73	63.70	17.60	82.43	63	163.86	63.61	17.48	82.77	126	163.69	63.40	17.43	82.85
1	163.35	63.58	17.51	82.26	64	163.93	63.66	17.54	82.73	127	163.82	63.58	17.52	82.72
2	164.00	63.85	17.42	82.74	65	163.75	63.38	17.53	82.84	128	163.42	63.39	17.53	82.50
3	164.10	63.68	17.60	82.82	66	163.87	63.67	17.41	82.79	129	163.77	63.70	17.48	82.58
4	163.53	63.56	17.50	82.48	67	163.64	63.55	17.37	82.72	130	164.15	63.60	17.54	83.01
5	164.21	63.66	17.49	83.05	68	164.28	63.66	17.37	83.24	131	163.81	63.60	17.65	82.56
6	163.51	63.67	17.51	82.34	69	164.04	63.77	17.59	82.68	132	163.66	63.55	17.49	82.63
7	163.75	63.54	17.43	82.79	70	163.95	63.55	17.59	82.82	133	163.62	63.35	17.58	82.69
8	163.99	63.66	17.54	82.78	71	164.14	63.42	17.55	83.17	134	164.08	63.58	17.33	83.17
9	164.10	63.64	17.63	82.84	72	162.98	63.50	17.32	82.17	135	163.48	63.67	17.42	82.39
10	163.73	63.46	17.56	82.71	73	163.65	63.55	17.44	82.66	136	161.71	62.96	17.31	81.45
11	163.74	63.58	17.42	82.74	74	163.79	63.65	17.48	82.66	137	165.26	64.21	17.61	83.44
12	164.02	63.60	17.54	82.88	75	163.38	63.49	17.49	82.40	138	163.96	63.61	17.65	82.70
13	164.01	63.75	17.60	82.66	76	163.88	63.61	17.49	82.78	139	163.63	63.74	17.41	82.48
14	164.00	63.56	17.45	82.99	77	163.61	63.71	17.37	82.53	140	163.35	63.50	17.51	82.34
15	164.20	63.49	17.68	83.03	78	163.47	63.58	17.56	82.33	141	163.40	63.57	17.51	82.32
16	163.78	63.64	17.47	82.67	79	163.73	63.63	17.52	82.59	142	163.17	63.32	17.54	82.31
17	163.57	63.51	17.57	82.49	80	164.29	63.77	17.55	82.97	143	163.64	63.56	17.51	82.57
18	163.74	63.54	17.45	82.76	81	164.07	63.73	17.52	82.82	144	163.45	63.52	17.48	82.44
19	163.72	63.49	17.54	82.68	82	163.64	63.57	17.46	82.61	145	163.66	63.73	17.54	82.39
20	163.88	63.73	17.43	82.72	83	163.90	63.65	17.48	82.76	146	163.77	63.73	17.50	82.54
21	163.64	63.55	17.49	82.61	84	163.84	63.54	17.55	82.75	147	163.93	63.58	17.36	82.99
22	163.57	63.54	17.45	82.58	85	163.23	63.43	17.38	82.43	148	163.17	63.38	17.51	82.28
23	163.85	63.63	17.58	82.64	86	163.84	63.62	17.36	82.86	149	163.60	63.58	17.43	82.60
24	163.92	63.67	17.45	82.81	87	163.91	63.50	17.44	82.97	150	163.96	63.62	17.69	82.65
25	163.86	63.63	17.49	82.74	88	163.93	63.93	17.48	82.52	151	164.10	63.56	17.53	83.00
26	163.32	63.38	17.51	82.43	89	163.84	63.72	17.54	82.57	152	163.70	63.59	17.42	82.70
27	163.50	63.72	17.28	82.50	90	164.24	63.81	17.46	82.97	153	163.51	63.47	17.48	82.56
28	163.53	63.57	17.49	82.46	91	163.66	63.49	17.54	82.63	154	163.81	63.59	17.54	82.68
29	163.22	63.47	17.52	82.23	92	163.94	63.55	17.51	82.87	155	163.83	63.55	17.58	82.70
30	163.91	63.68	17.50	82.73	93	163.58	63.73	17.57	82.28	156	163.79	63.60	17.37	82.82
31	164.18	63.59	17.59	83.00	94	163.80	63.65	17.41	82.74	157	163.63	63.65	17.36	82.62
32	163.39	63.59	17.47	82.32	95	163.81	63.63	17.49	82.69	158	163.80	63.85	17.62	82.33
33	163.33	63.40	17.52	82.41	96	163.29	63.49	17.47	82.33	159	163.47	63.57	17.34	82.56
34	164.01	63.59	17.58	82.84	97	163.32	63.52	17.36	82.43	160	163.74	63.74	17.46	82.55
35	164.01	63.62	17.49	82.89	98	163.38	63.64	17.43	82.30	161	163.80	63.57	17.43	82.80
36	163.62	63.41	17.58	82.63	99	163.24	63.37	17.43	82.45	162	163.83	63.41	17.57	82.85
37	163.82	63.69	17.44	82.69	100	163.63	63.56	17.43	82.64	163	163.96	63.85	17.37	82.74
38	163.98	63.69	17.46	82.84	101	163.80	63.57	17.54	82.68	164	163.38	63.64	17.35	82.38
39	163.64	63.56	17.40	82.68	102	163.77	63.67	17.46	82.65	165	163.87	63.67	17.47	82.73
40	163.19	63.47	17.59	82.13	103	163.56	63.42	17.48	82.65	166	163.79	63.56	17.54	82.70
41	163.87	63.62	17.54	82.71	104	163.93	63.70	17.53	82.69	167	164.16	63.53	17.49	83.14
42	164.13	63.48	17.61	83.04	105	163.39	63.40	17.45	82.54	168	163.60	63.31	17.51	82.78
43	163.73	63.59	17.50	82.63	106	163.90	63.63	17.41	82.86	169	163.42	63.49	17.55	82.38
44	163.41	63.66	17.43	82.33	107	163.96	63.76	17.44	82.76	170	163.52	63.50	17.54	82.49
45	163.62	63.63	17.40	82.59	108	163.31	63.46	17.42	82.43	171	163.38	63.51	17.56	82.31
46	163.26	63.49	17.45	82.32	109	163.46	63.63	17.50	82.33	172	164.04	63.59	17.50	82.95
47	163.60	63.45	17.50	82.65	110	163.94	63.73	17.47	82.75	173	163.07	63.21	17.42	82.44
48	163.50	63.49	17.53	82.48	111	162.57	63.10	17.46	82.02	174	163.77	63.71	17.43	82.62
49	163.63	63.44	17.42	82.77	112	160.68	62.36	17.29	81.03	175	163.67	63.46	17.56	82.65
50	163.80	63.79	17.53	82.47	113	167.61	65.25	17.87	84.50	176	163.79	63.62	17.53	82.65
51	163.98	63.69	17.61	82.69	114	164.23	63.89	17.63	82.71	177	164.05	63.71	17.43	82.92
52	163.41	63.66	17.35	82.39	115	163.44	63.68	17.46	82.30	178	163.15	63.59	17.35	82.22
53	163.89	63.72	17.46	82.70	116	163.70	63.57	17.52	82.62	179	164.03	63.70	17.45	82.88
54	163.66	63.54	17.57	82.55	117	163.76	63.65	17.42	82.70	180	163.73	63.69	17.42	82.63
55	163.68	63.49	17.37	82.82	118	162.79	63.25	17.40	82.13	181	164.01	63.40	17.44	83.17
56	163.77	63.54	17.44	82.78	119	164.84	63.90	17.70	83.23	182	160.21	62.28	16.98	80.95
57	163.77	63.52	17.45	82.80	120	163.47	63.49	17.40	82.58					
58	163.55	63.45	17.53	82.58	121	163.67	63.57	17.39	82.71					
59	163.40	63.25	17.39	82.76	122	163.78	63.56	17.50	82.71					
60	163.83	63.61	17.47	82.75	123	163.59	63.58	17.57	82.44					
61	163.83	63.65	17.50	82.67	124	163.52	63.65	17.47	82.40					
62	163.17	63.30	17.51	82.36	125	163.62	63.62	17.48	82.52					

Sustainability – Data Rate Distribution Graph

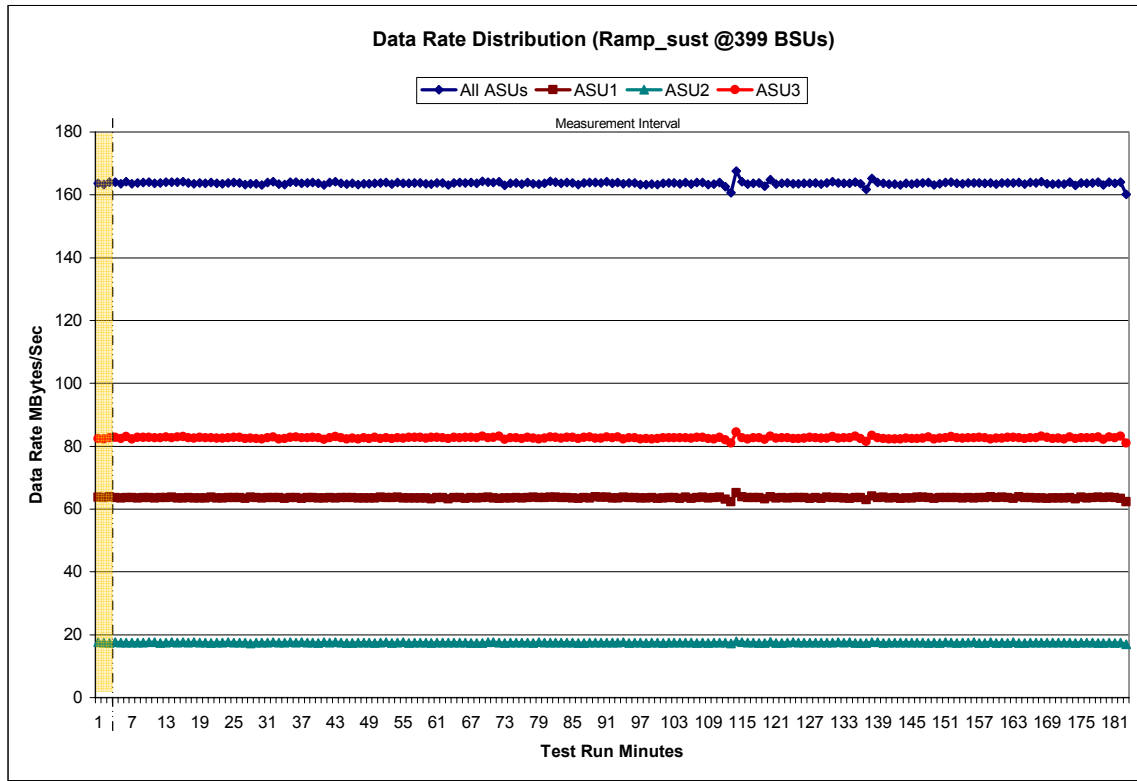

Sustainability – I/O Request Throughput Distribution Graph

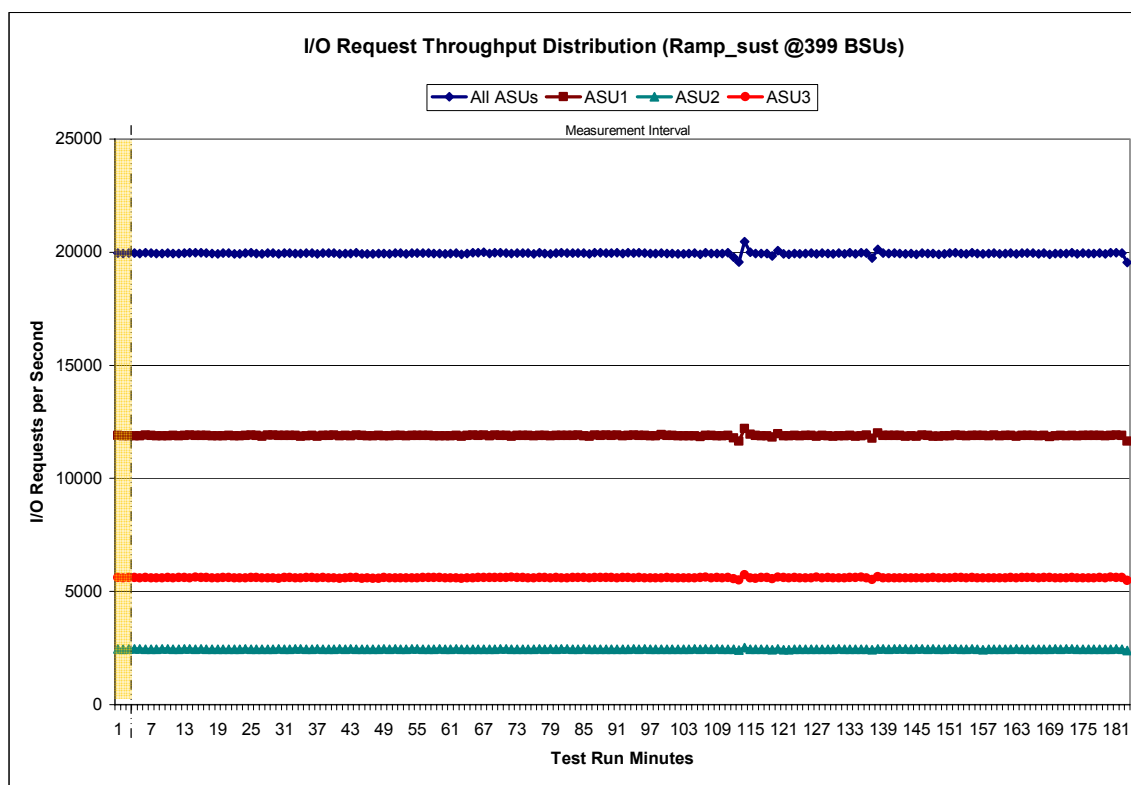

Sustainability – Measured Intensity Multiplier and Coefficient of Variation

	ASU1-1	ASU1-2	ASU1-3	ASU1-4	ASU2-1	ASU2-2	ASU2-3	ASU3-1
<i>IM</i>	0.0350	0.2810	0.0700	0.2100	0.0180	0.0700	0.0350	0.2810
<i>MIM</i>	0.0350	0.2810	0.0700	0.2100	0.0180	0.0700	0.0350	0.2810
<i>COV</i>	0.004	0.002	0.003	0.002	0.007	0.003	0.005	0.002

IM – Intensity Multiplier: The ratio of I/Os for each I/O stream relative to the total I/Os for all I/O streams (ASU1-1 – ASU3-1) as required by the benchmark specification.

MIM – Measured Intensity Multiplier: The Measured Intensity Multiplier represents the ratio of measured I/Os for each I/O stream relative to the total I/Os measured for all I/O streams (ASU1-1 – ASU3-1). This value may differ from the corresponding Expected Intensity Multiplier by no more than 5%.

COV – Coefficient of Variation: This measure of variation for the Measured Intensity Multiplier cannot exceed 0.2.

Primary Metrics Test – IOPS Test Phase

Clause 5.4.2.2

The IOPS Test Phase consists of one Test Run at the 100% load point with a Measurement Interval of ten (10) minutes. The IOPS Test Phase immediately follows the Sustainability Test Phase without any interruption or manual intervention.

The IOPS Test Run generates the SPC-1 IOPS™ primary metric, which is computed as the I/O Request Throughput for the Measurement Interval of the IOPS Test Run.

The Average Response Time is computed for the IOPS Test Run and cannot exceed 30 milliseconds. If the Average Response Time exceeds the 30 millisecond constraint, the measurement is invalid.

Clause 9.2.4.7.2

For the IOPS Test Phase the FDR shall contain:

- 1. I/O Request Throughput Distribution (data and graph).*
- 2. A Response Time Frequency Distribution.*
- 3. An Average Response Time Distribution.*
- 4. The human readable Test Run Results File produced by the Workload Generator.*
- 5. A listing or screen image of all input parameters supplied to the Workload Generator.*
- 6. The total number of I/O Requests completed in the Measurement Interval as well as the number of I/O Requests with a Response Time less than or equal to 30 milliseconds and the number of I/O Requests with a Response Time greater than 30 milliseconds.*

SPC-1 Workload Generator Input Parameters

The SPC-1 Workload Generator input parameters for the Sustainability, IOPS, and Response Time Ramp Test Runs are listed below:

java metrics -b 399 -r 780

IOPS Test Results File

A link to the test results file generated from the IOPS Test Run is listed below.

[IOPS Test Results File](#)

IOPS Test Run – I/O Request Throughput Distribution Data

399 BSUs				
	Start	Stop	Interval	Duration
Start-Up/Ramp-Up	11:01:53	11:04:54	0-2	0:03:01
Measurement Interval	11:04:54	11:14:54	3-12	0:10:00
60 second intervals	All ASUs	ASU1	ASU2	ASU3
0	19,941.22	11,871.52	2,457.23	5,612.47
1	19,922.80	11,895.23	2,444.60	5,582.97
2	19,955.57	11,894.08	2,452.62	5,608.87
3	19,938.35	11,891.27	2,459.00	5,588.08
4	19,947.70	11,891.12	2,453.87	5,602.72
5	19,967.37	11,890.33	2,462.53	5,614.50
6	19,960.72	11,897.22	2,454.82	5,608.68
7	19,971.42	11,903.48	2,448.67	5,619.27
8	19,964.87	11,903.10	2,453.05	5,608.72
9	19,924.30	11,879.60	2,432.65	5,612.05
10	19,929.90	11,883.60	2,448.35	5,597.95
11	19,940.17	11,882.48	2,450.92	5,606.77
12	19,952.53	11,900.15	2,450.17	5,602.22
Average	19,949.73	11,892.24	2,451.40	5,606.10

IOPS Test Run – I/O Request Throughput Distribution Graph

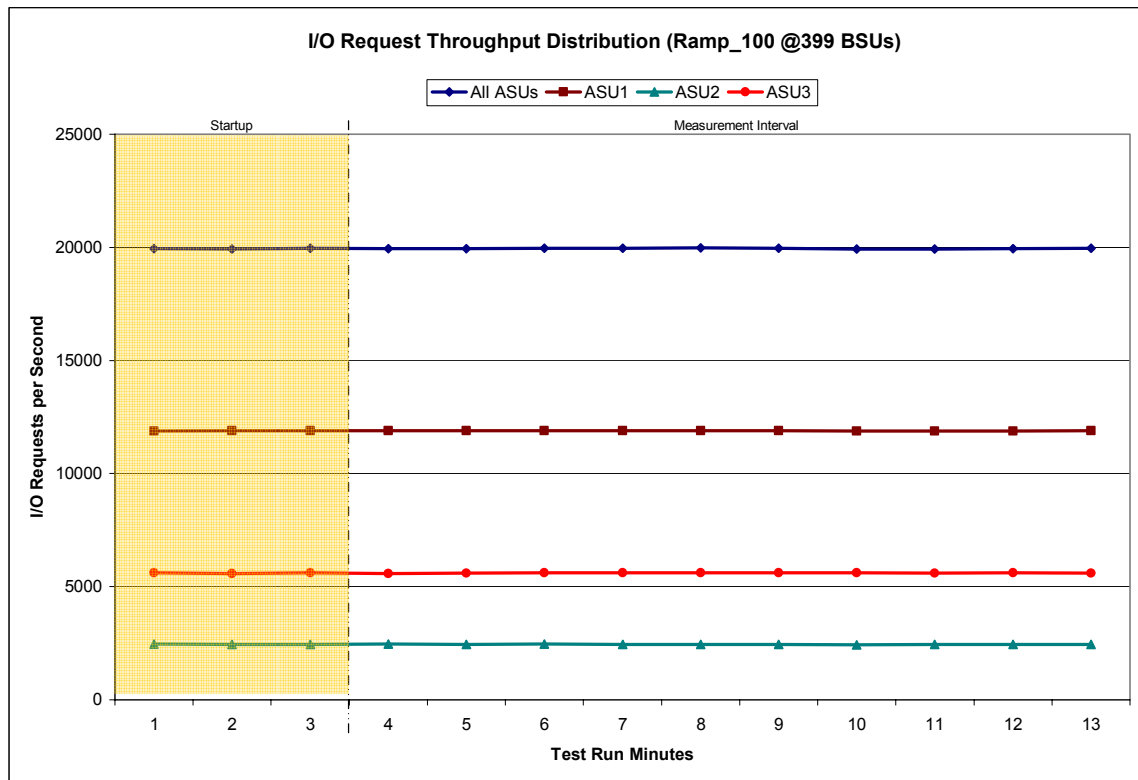

IOPS Test Run – Response Time Frequency Distribution Data

Response Time (ms)	0-0.25	>0.25-0.5	>0.5-0.75	>0.75-1.0	>1.0-1.25	>1.25-1.5	>1.5-1.75	>1.75-2.0
Read	2172	85,025	30,673	10,810	5,299	2,343	1,238	1,053
Write	0	515,588	1,961,564	1,444,248	1,376,392	928,666	475,294	366,219
All ASUs	2172	600,613	1,992,237	1,455,058	1,381,691	931,009	476,532	367,272
ASU1	1819	394,601	1,123,488	756,798	650,689	360,853	156,985	125,949
ASU2	353	126,748	382,656	203,659	124,545	52,339	18,994	12,816
ASU3	0	79,264	486,093	494,601	606,457	517,817	300,553	228,507
Response Time (ms)	>2.0-2.5	>2.5-3.0	>3.0-3.5	>3.5-4.0	>4.0-4.5	>4.5-5.0	>5.0-6.0	>6.0-7.0
Read	3,656	7,015	14,300	17,330	35,700	45,301	119,381	176,016
Write	785,767	364,441	216,809	125,449	132,571	81,246	107,838	87,970
All ASUs	789,423	371,456	231,109	142,779	168,271	126,547	227,219	263,986
ASU1	248,279	98,529	58,245	41,234	59,220	55,609	122,728	165,647
ASU2	19,210	6,909	5,519	5,327	7,755	8,905	22,275	33,265
ASU3	521,934	266,018	167,345	96,218	101,296	62,033	82,216	65,074
Response Time (ms)	>7.0-8.0	>8.0-9.0	>9.0-10.0	>10.0-15.0	>15.0-20.0	>20.0-25.0	>25.0-30.0	>30.0
Read	168,906	199,667	166,393	753,098	537,656	431,825	353,183	2,887,203
Write	57,891	51,877	37,235	78,023	25,316	13,297	10,331	51,820
All ASUs	226,797	251,544	203,628	831,121	562,972	445,122	363,514	2,939,023
ASU1	153,436	175,898	143,092	621,904	439,428	355,463	293,883	2,547,847
ASU2	31,988	38,086	31,916	146,916	106,231	82,939	65,235	351,911
ASU3	41,373	37,560	28,620	62,301	17,313	6,720	4,396	39,265

IOPS Test Run –Response Time Frequency Distribution Graph

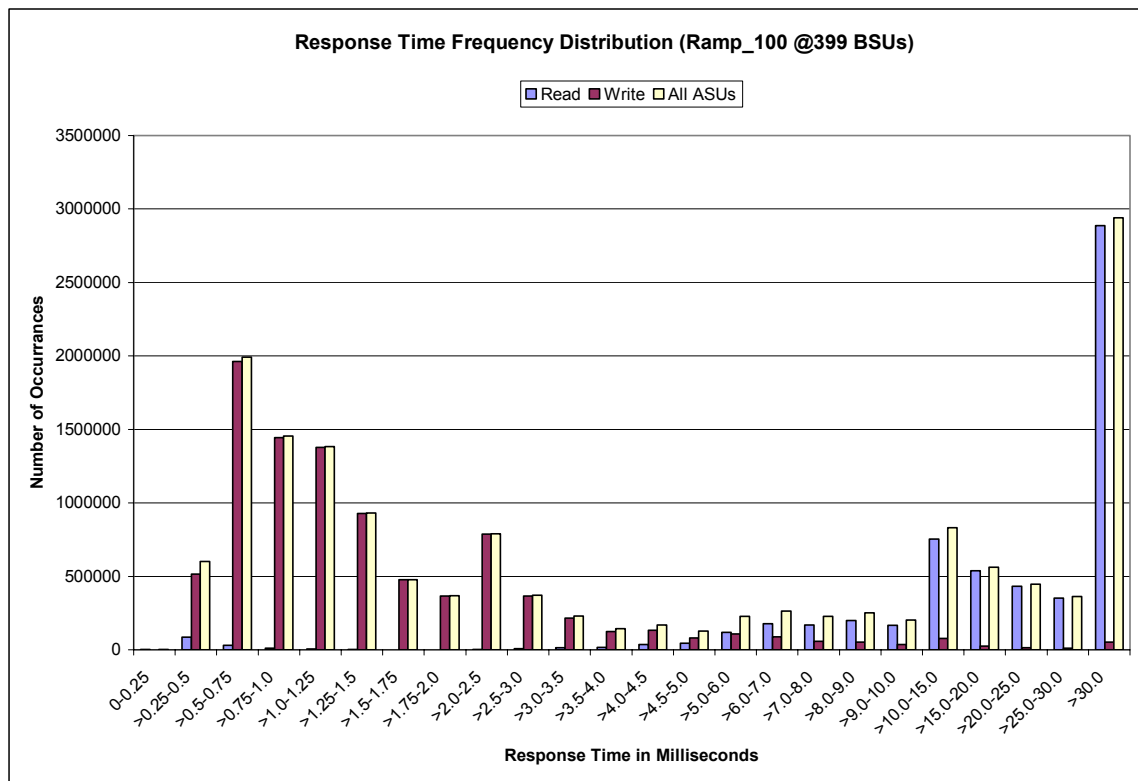

IOPS Test Run – Average Response Time (ms) Distribution Data

399 BSUs	Start	Stop	Interval	Duration
<i>Start-Up/Ramp-Up</i>	0:00:00	0:00:00	0-2	0:00:00
<i>Measurement Interval</i>	0:00:00	0:00:00	3-12	0:00:00
60 second intervals	All ASUs	ASU1	ASU2	ASU3
0	15.09	21.26	14.95	2.10
1	18.76	25.99	18.63	3.41
2	18.47	25.80	18.41	2.93
3	18.67	25.97	18.86	3.07
4	18.74	26.13	18.62	3.10
5	18.75	26.13	19.01	2.99
6	18.65	26.00	18.76	2.99
7	19.85	28.14	18.27	2.97
8	24.49	35.25	18.80	4.13
9	18.93	26.52	18.08	3.24
10	18.96	26.28	18.62	3.58
11	18.37	25.65	18.36	2.94
12	18.60	26.02	18.15	3.05
Average	19.40	27.21	18.55	3.21

IOPS Test Run – Average Response Time (ms) Distribution Graph

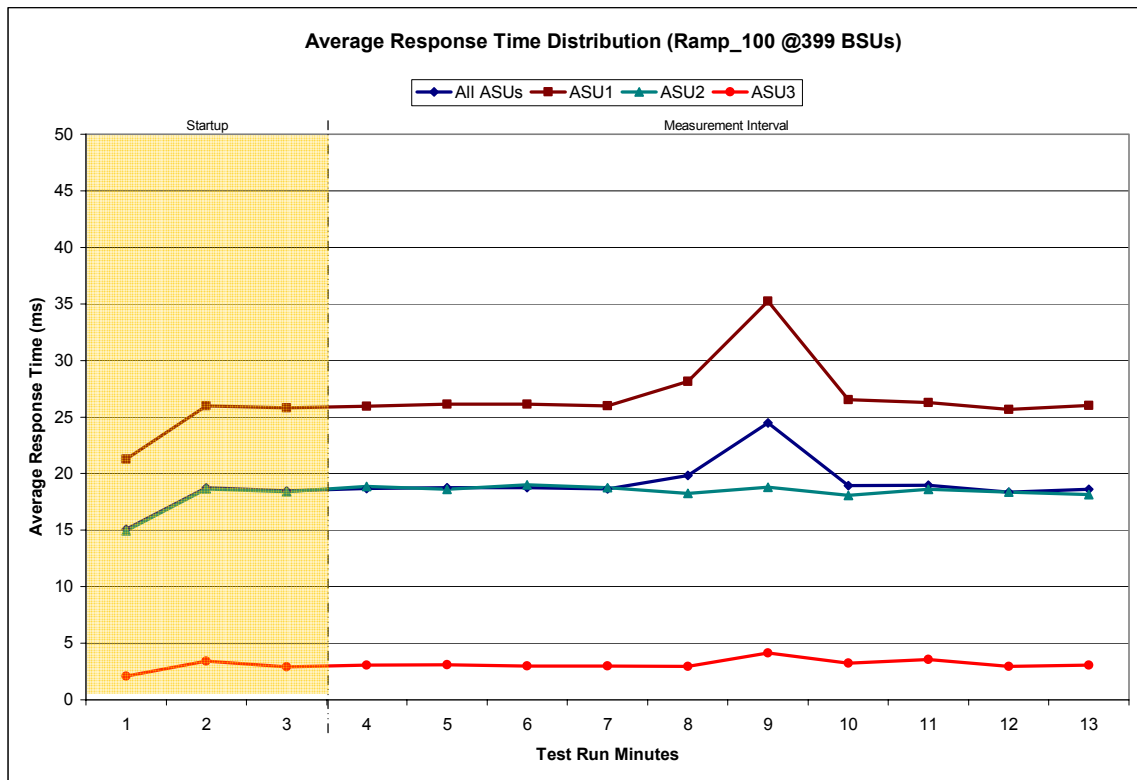

IOPS Test Run – I/O Request Information

I/O Requests Completed in the Measurement Interval	I/O Requests Completed with Response Time = or < 30 ms	I/O Requests Completed with Response Time > 30 ms
15,351,095	12,412,072	2,939,023

IOPS Test Run – Measured Intensity Multiplier and Coefficient of Variation

	ASU1-1	ASU1-2	ASU1-3	ASU1-4	ASU2-1	ASU2-2	ASU2-3	ASU3-1
<i>IM</i>	0.0350	0.2810	0.0700	0.2100	0.0180	0.0700	0.0350	0.2810
<i>MIM</i>	0.0350	0.2811	0.0700	0.2101	0.0180	0.0699	0.0350	0.2810
<i>COV</i>	0.005	0.001	0.003	0.001	0.007	0.004	0.004	0.001

IM – Intensity Multiplier: The ratio of I/Os for each I/O stream relative to the total I/Os for all I/O streams (ASU1-1 – ASU3-1) as required by the benchmark specification.

MIM – Measured Intensity Multiplier: The Measured Intensity Multiplier represents the ratio of measured I/Os for each I/O stream relative to the total I/Os measured for all I/O streams (ASU1-1 – ASU3-1). This value may differ from the corresponding Expected Intensity Multiplier by no more than 5%.

COV – Coefficient of Variation: This measure of variation for the Measured Intensity Multiplier cannot exceed 0.2.

Primary Metrics Test – Response Time Ramp Test Phase

Clause 5.4.2.3

The Response Time Ramp Test Phase consists of five Test Runs, one each at 95%, 90%, 80%, 50%, and 10% of the load point (100%) used to generate the SPC-1 IOPS™ primary metric. Each of the five Test Runs has a Measurement Interval of ten (10) minutes. The Response Time Ramp Test Phase immediately follows the IOPS Test Phase without any interruption or manual intervention.

The five Response Time Ramp Test Runs, in conjunction with the IOPS Test Run (100%), demonstrate the relationship between Average Response Time and I/O Request Throughput for the Tested Storage Configuration (TSC) as illustrated in the response time/throughput curve on page 11.

In addition, the Average Response Time measured during the 10% Test Run is the value for the SPC-1 LRT™ primary metric. That value represents the Average Response Time of a lightly loaded TSC.

Clause 9.2.4.7.3

The following content shall appear in the FDR for the Response Time Ramp Phase:

- 1. A Response Time Ramp Distribution.*
- 2. The human readable Test Run Results File produced by the Workload Generator for each Test Run within the Response Time Ramp Test Phase.*
- 3. For the 10% Load Level Test Run (SPC-1 LRT™ metric) an Average Response Time Distribution.*
- 4. A listing or screen image of all input parameters supplied to the Workload Generator.*

SPC-1 Workload Generator Input Parameters

The SPC-1 Workload Generator input parameters for the Sustainability, IOPS, and Response Time Ramp Test Runs are listed below:

java metrics -b 399 -r 780

Response Time Ramp Test Results File

A link to each test result file generated from each Response Time Ramp Test Run list listed below.

[95% Load Level](#)

[90% Load Level](#)

[80% Load Level](#)

[50% Load Level](#)

[10% Load Level](#)

Response Time Ramp Distribution (IOPS) Data

The five Test Runs that comprise the Response Time Ramp Phase are executed at 95%, 90%, 80%, 50%, and 10% of the Business Scaling Unit (BSU) load level used to produce the SPC-1 IOPS™ primary metric. The 100% BSU load level is included in the following Response Time Ramp data tables and graphs for completeness.

100% Load Level - 399 BSUs					95% Load Level - 379 BSUs				
Start-Up/Ramp-Up Measurement Interval	Start	Stop	Interval	Duration	Start-Up/Ramp-Up Measurement Interval	Start	Stop	Interval	Duration
(60 second intervals)	All ASUs	ASU-1	ASU-2	ASU-3	(60 second intervals)	All ASUs	ASU-1	ASU-2	ASU-3
0	19,941.22	11,871.52	2,457.23	5,612.47	0	18,971.15	11,326.90	2,338.67	5,305.58
1	19,922.80	11,895.23	2,444.60	5,582.97	1	18,927.73	11,288.62	2,320.67	5,318.45
2	19,955.57	11,894.08	2,452.62	5,608.87	2	18,945.05	11,279.62	2,331.28	5,334.15
3	19,938.35	11,891.27	2,459.00	5,588.08	3	18,973.02	11,315.50	2,327.07	5,330.45
4	19,947.70	11,891.12	2,453.87	5,602.72	4	18,972.43	11,283.97	2,353.45	5,335.02
5	19,967.37	11,890.33	2,462.53	5,614.50	5	18,982.68	11,307.85	2,337.88	5,336.95
6	19,960.72	11,897.22	2,454.82	5,608.68	6	18,962.22	11,301.98	2,331.95	5,328.28
7	19,971.42	11,903.48	2,448.67	5,619.27	7	18,923.90	11,277.65	2,329.03	5,317.22
8	19,964.87	11,903.10	2,453.05	5,608.72	8	18,938.28	11,282.72	2,329.58	5,325.98
9	19,924.30	11,879.60	2,432.65	5,612.05	9	18,957.70	11,287.18	2,339.88	5,330.63
10	19,929.90	11,883.60	2,448.35	5,597.95	10	18,911.20	11,257.33	2,330.97	5,322.90
11	19,940.17	11,882.48	2,450.92	5,606.77	11	18,952.95	11,283.85	2,330.95	5,338.15
12	19,952.53	11,900.15	2,450.17	5,602.22	12	18,943.55	11,293.35	2,328.38	5,321.82
Average	19,949.73	11,892.24	2,451.40	5,606.10	Average	18,951.79	11,289.14	2,333.92	5,328.74
90% Load Level - 359 BSUs					80% Load Level - 319 BSUs				
Start-Up/Ramp-Up Measurement Interval	Start	Stop	Interval	Duration	Start-Up/Ramp-Up Measurement Interval	Start	Stop	Interval	Duration
(60 second intervals)	All ASUs	ASU-1	ASU-2	ASU-3	(60 second intervals)	All ASUs	ASU-1	ASU-2	ASU-3
0	17,951.72	10,702.02	2,209.80	5,039.90	0	15,953.78	9,513.97	1,969.00	4,470.82
1	17,939.90	10,682.57	2,199.42	5,057.92	1	15,930.78	9,506.58	1,949.87	4,474.33
2	17,933.83	10,677.78	2,215.65	5,040.40	2	15,969.58	9,523.38	1,957.22	4,488.98
3	17,948.78	10,692.43	2,201.92	5,054.43	3	15,947.25	9,500.72	1,963.50	4,483.03
4	17,965.37	10,713.33	2,205.02	5,047.02	4	15,917.05	9,487.03	1,967.12	4,462.90
5	17,906.05	10,672.43	2,198.82	5,034.80	5	15,941.97	9,508.60	1,961.18	4,472.18
6	17,950.15	10,702.52	2,204.80	5,042.83	6	15,950.25	9,505.98	1,963.82	4,480.45
7	17,959.58	10,702.80	2,208.52	5,048.27	7	15,938.70	9,498.15	1,964.30	4,476.25
8	17,960.53	10,697.05	2,211.30	5,052.18	8	15,972.47	9,523.48	1,969.32	4,479.67
9	17,974.07	10,710.73	2,214.42	5,048.92	9	15,973.50	9,511.70	1,965.13	4,496.67
10	17,938.27	10,692.68	2,204.22	5,041.37	10	15,948.47	9,507.70	1,959.68	4,481.08
11	17,935.67	10,690.78	2,202.07	5,042.82	11	15,969.73	9,517.25	1,967.90	4,484.58
12	17,971.43	10,724.80	2,204.35	5,042.28	12	15,946.88	9,503.97	1,963.28	4,479.63
Average	17,950.99	10,699.96	2,205.54	5,045.49	Average	15,950.63	9,506.46	1,964.52	4,479.65
50% Load Level - 199 BSUs					10% Load Level - 39 BSUs				
Start-Up/Ramp-Up Measurement Interval	Start	Stop	Interval	Duration	Start-Up/Ramp-Up Measurement Interval	Start	Stop	Interval	Duration
(60 second intervals)	All ASUs	ASU-1	ASU-2	ASU-3	(60 second intervals)	All ASUs	ASU-1	ASU-2	ASU-3
0	9,959.15	5,943.05	1,225.13	2,790.97	0	1,954.22	1,168.83	236.97	548.42
1	9,938.22	5,924.45	1,227.00	2,786.77	1	1,951.70	1,164.93	234.35	552.42
2	9,954.98	5,921.97	1,225.43	2,807.58	2	1,953.25	1,166.35	239.43	547.47
3	9,961.37	5,931.55	1,224.37	2,805.45	3	1,946.63	1,156.82	238.88	550.93
4	9,937.13	5,928.20	1,211.48	2,797.45	4	1,934.15	1,158.50	235.07	540.58
5	9,938.48	5,920.18	1,228.93	2,789.37	5	1,949.45	1,163.82	239.92	545.72
6	9,954.78	5,930.22	1,225.57	2,799.00	6	1,950.02	1,163.52	240.63	545.87
7	9,956.27	5,934.87	1,219.05	2,802.35	7	1,946.43	1,160.07	238.33	548.03
8	9,953.98	5,935.52	1,217.18	2,801.28	8	1,952.55	1,161.45	241.17	549.93
9	9,950.70	5,930.62	1,234.73	2,785.35	9	1,955.48	1,165.00	242.32	548.17
10	9,959.75	5,929.83	1,227.68	2,802.23	10	1,957.72	1,165.02	235.98	556.72
11	9,948.37	5,928.33	1,220.92	2,799.12	11	1,954.33	1,161.03	241.15	552.15
12	9,950.13	5,923.97	1,230.90	2,795.27	12	1,955.78	1,163.25	245.28	547.25
Average	9,951.10	5,929.33	1,224.08	2,797.69	Average	1,950.26	1,161.85	239.87	548.54

Response Time Ramp Distribution (IOPS) Graph

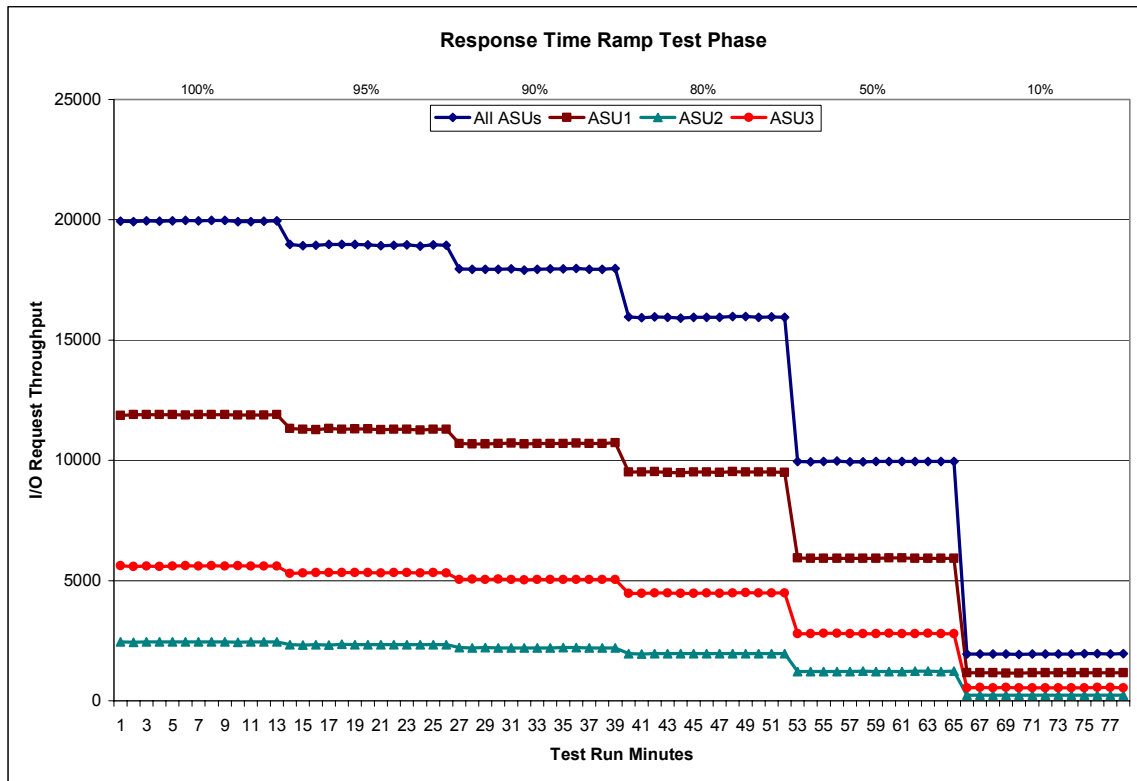

SPC-1 LRT™ Average Response Time (ms) Distribution Data

39 BSUs	Start	Stop	Interval	Duration
<i>Start-Up/Ramp-Up</i>	12:22:23	12:25:24	0-2	0:03:01
<i>Measurement Interval</i>	12:25:24	12:35:24	3-12	0:10:00
60 second intervals	All ASUs	ASU1	ASU2	ASU3
0	2.96	4.14	2.83	0.50
1	2.66	3.66	2.85	0.50
2	2.65	3.63	2.79	0.50
3	2.64	3.63	2.83	0.50
4	2.64	3.61	2.83	0.50
5	2.66	3.63	2.83	0.50
6	2.66	3.65	2.79	0.50
7	2.64	3.62	2.78	0.50
8	2.65	3.62	2.89	0.50
9	2.66	3.63	2.83	0.50
10	2.63	3.62	2.79	0.50
11	2.63	3.60	2.86	0.50
12	2.67	3.66	2.82	0.50
Average	2.65	3.63	2.83	0.50

SPC-1 LRT™ Average Response Time (ms) Distribution Graph

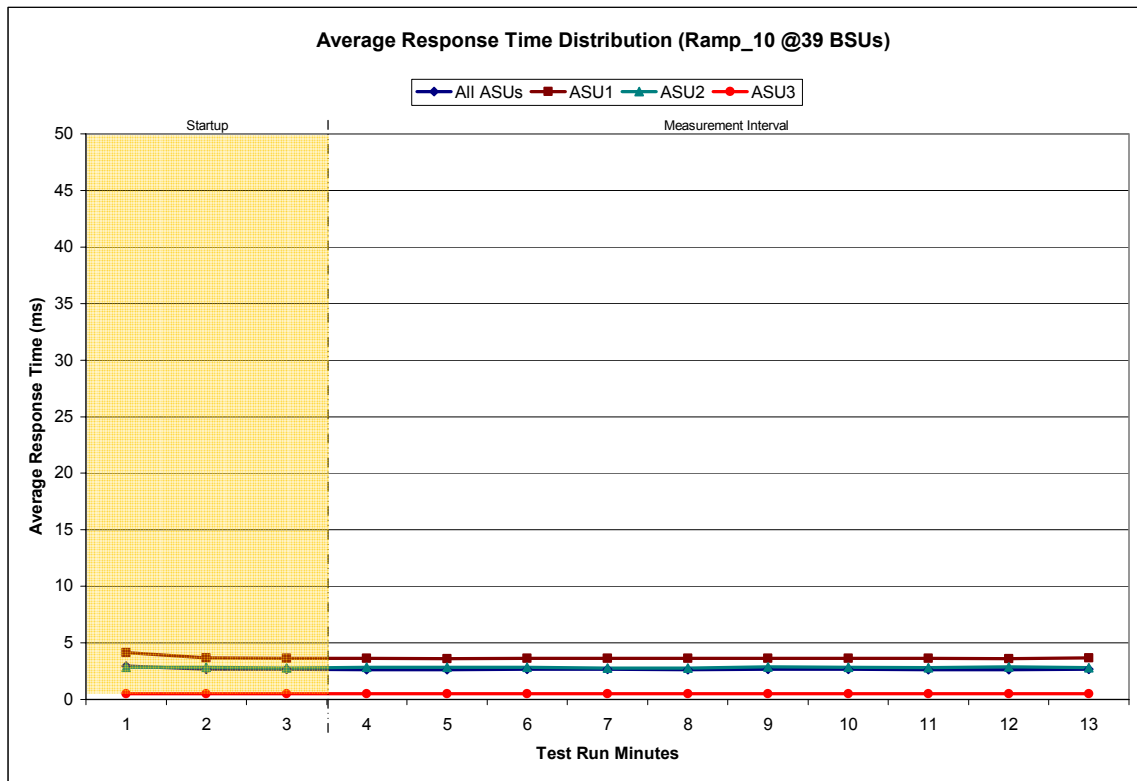

SPC-1 LRT™ (10%) – Measured Intensity Multiplier and Coefficient of Variation

	ASU1-1	ASU1-2	ASU1-3	ASU1-4	ASU2-1	ASU2-2	ASU2-3	ASU3-1
<i>IM</i>	0.0350	0.2810	0.0700	0.2100	0.0180	0.0700	0.0350	0.2810
<i>MIM</i>	0.0350	0.2809	0.0698	0.2100	0.0181	0.0701	0.0348	0.2813
<i>COV</i>	0.014	0.004	0.009	0.004	0.020	0.010	0.018	0.006

IM – Intensity Multiplier: The ratio of I/Os for each I/O stream relative to the total I/Os for all I/O streams (ASU1-1 – ASU3-1) as required by the benchmark specification.

MIM – Measured Intensity Multiplier: The Measured Intensity Multiplier represents the ratio of measured I/Os for each I/O stream relative to the total I/Os measured for all I/O streams (ASU1-1 – ASU3-1). This value may differ from the corresponding Expected Intensity Multiplier by no more than 5%.

COV – Coefficient of Variation: This measure of variation for the Measured Intensity Multiplier cannot exceed 0.2.

Repeatability Test

Clause 5.4.3

The Repeatability Test demonstrates the repeatability and reproducibility of the SPC-1 IOPS™ and SPC-1 LRT™ primary metrics generated in earlier Test Runs.

There are two identical Repeatability Test Phases. Each Test Phase contains two Test Runs. Each of the Test Runs will have a Measurement Interval of no less than ten (10) minutes. The two Test Runs in each Test Phase will be executed without interruption or any type of manual intervention.

The first Test Run in each Test Phase is executed at the 10% load point. The Average Response Time from each of the Test Runs is compared to the SPC-1 LRT™ primary metric. Each Average Response Time value must be less than the SPC-1 LRT™ primary metric plus 5%.

The second Test Run in each Test Phase is executed at the 100% load point. The I/O Request Throughput from the Test Runs is compared to the SPC-1 IOPS™ primary metric. Each I/O Request Throughput value must be greater than the SPC-1 IOPS™ primary metric minus 5%. In addition, the Average Response Time for each Test Run cannot exceed 30 milliseconds.

If any of the above constraints are not met, the benchmark measurement is invalid.

Clause 9.2.4.7.3

The following content shall appear in the FDR for each Test Run in the two Repeatability Test Phases:

- 1. A table containing the results of the two Repeatability Test Phases. The content, appearance, and format of the table are specified in Table 9-11.*
- 2. An I/O Request Throughput Distribution (data and graph).*
- 3. An Average Response Time Distribution (data and graph).*
- 4. The human readable Test Run Results File produced by the Workload Generator.*
- 5. A listing or screen image of all input parameters supplied to the Workload Generator.*

SPC-1 Workload Generator Input Parameters

The SPC-1 Workload Generator input parameters for the Repeatability Test Runs are listed below:

java repeat1 -b 399

java repeat2 -b 399

Repeatability Test Results File

The values for the SPC-1 IOPS™, SPC-1 LRT™, and the Repeatability Test measurements are listed below.

	SPC-1 IOPS™	SPC-1 LRT™
Primary Metrics	19,949.73	2.65
Repeatability Test Phase 1	19,434.56	2.64
Repeatability Test Phase 2	19,686.33	2.67

A link to the test result file generated from each Repeatability Test Run list is listed below.

[Repeatability Test Phase 1, Test Run 1 \(LRT\)](#)

[Repeatability Test Phase 1, Test Run 2 \(IOPS\)](#)

[Repeatability Test Phase 2, Test Run 1 \(LRT\)](#)

[Repeatability Test Phase 2, Test Run 2 \(IOPS\)](#)

Repeatability 1 LRT – I/O Request Throughput Distribution Data

39 BSUs	Start	Stop	Interval	Duration
<i>Start-Up/Ramp-Up</i>	12:41:13	12:44:13	0-2	0:03:00
<i>Measurement Interval</i>	12:44:13	12:54:13	3-12	0:10:00
60 second intervals	All ASUs	ASU1	ASU2	ASU3
0	1,942.43	1,156.98	238.98	546.47
1	1,944.60	1,157.43	237.62	549.55
2	1,952.52	1,160.18	241.72	550.62
3	1,953.77	1,166.05	240.93	546.78
4	1,950.23	1,159.48	241.37	549.38
5	1,947.00	1,163.65	237.82	545.53
6	1,957.43	1,169.73	237.85	549.85
7	1,948.78	1,163.07	238.32	547.40
8	1,951.85	1,165.73	238.12	548.00
9	1,952.53	1,161.18	237.88	553.47
10	1,949.12	1,159.00	239.92	550.20
11	1,946.02	1,159.12	240.70	546.20
12	1,954.05	1,162.08	242.68	549.28
Average	1,951.08	1,162.91	239.56	548.61

Repeatability 1 LRT – I/O Request Throughput Distribution Graph

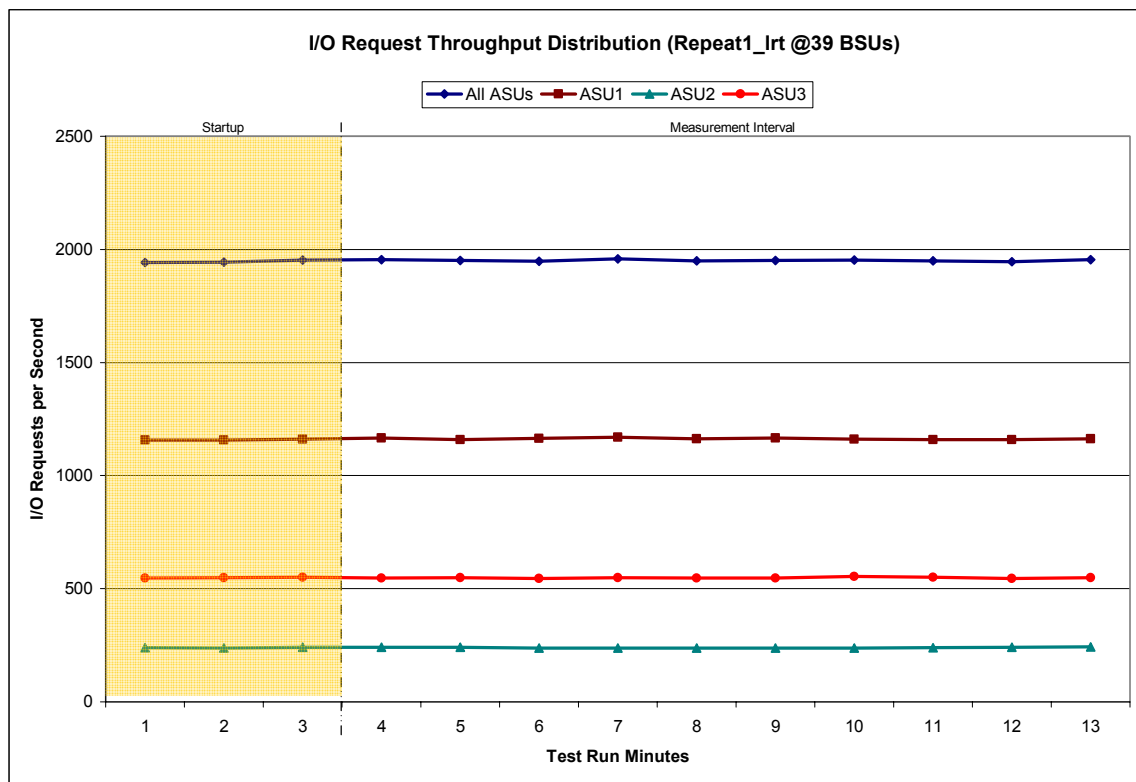

Repeatability 1 LRT –Average Response Time (ms) Distribution Data

39 BSUs	Start	Stop	Interval	Duration
<i>Start-Up/Ramp-Up</i>	12:41:13	12:44:13	0-2	0:03:00
<i>Measurement Interval</i>	12:44:13	12:54:13	3-12	0:10:00
60 second intervals	All ASUs	ASU1	ASU2	ASU3
0	2.65	3.63	2.81	0.50
1	2.63	3.60	2.82	0.50
2	2.61	3.57	2.84	0.50
3	2.62	3.59	2.76	0.50
4	2.63	3.59	2.84	0.50
5	2.63	3.61	2.76	0.50
6	2.67	3.65	2.88	0.50
7	2.65	3.63	2.82	0.50
8	2.66	3.63	2.86	0.50
9	2.63	3.61	2.79	0.50
10	2.64	3.61	2.81	0.50
11	2.64	3.61	2.86	0.50
12	2.66	3.64	2.85	0.50
Average	2.64	3.62	2.82	0.50

Repeatability 1 LRT –Average Response Time (ms) Distribution Graph

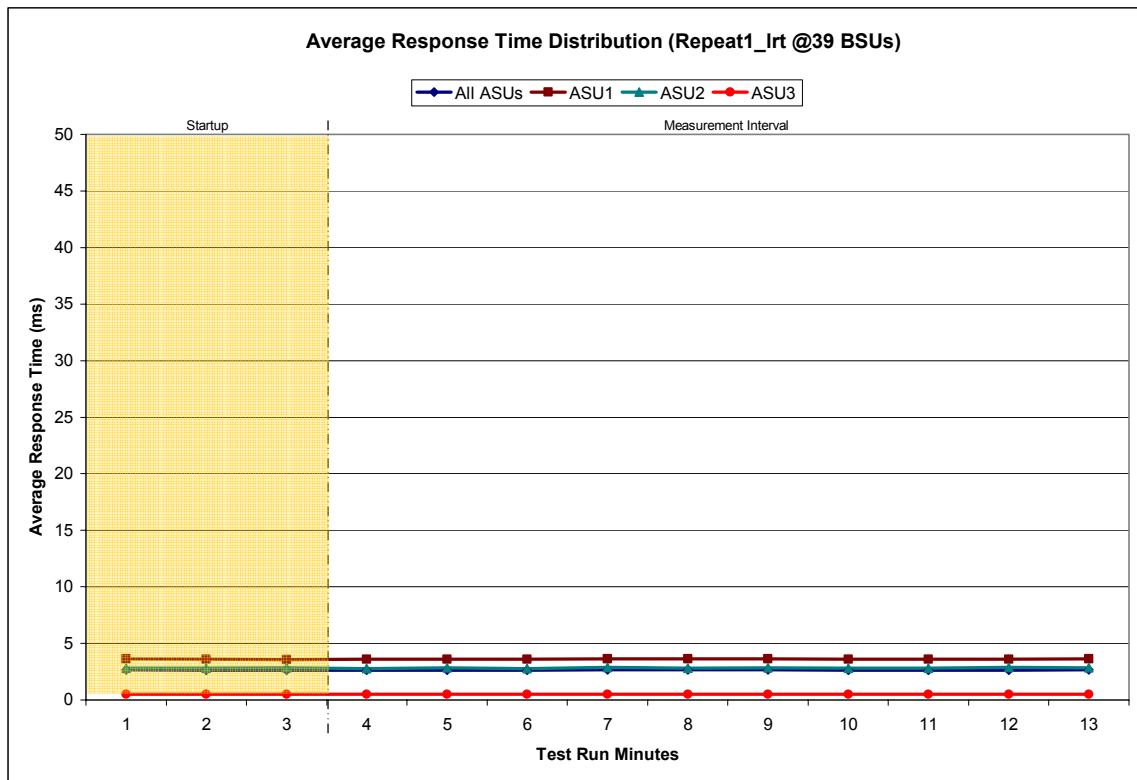

Repeatability 1 IOPS – I/O Request Throughput Distribution Data

399 BSUs	Start	Stop	Interval	Duration
<i>Start-Up/Ramp-Up</i>	12:54:18	12:57:19	0-2	0:03:01
<i>Measurement Interval</i>	12:57:19	13:07:19	3-12	0:10:00
60 second intervals	All ASUs	ASU1	ASU2	ASU3
0	19,968.08	11,892.57	2,466.20	5,609.32
1	19,987.60	11,908.43	2,466.95	5,612.22
2	19,955.20	11,880.52	2,471.22	5,603.47
3	19,951.63	11,900.93	2,453.33	5,597.37
4	19,963.85	11,906.73	2,457.03	5,600.08
5	19,949.75	11,876.37	2,444.83	5,628.55
6	19,962.83	11,890.78	2,450.35	5,621.70
7	19,944.30	11,883.85	2,450.28	5,610.17
8	19,943.95	11,881.60	2,458.53	5,603.82
9	19,909.35	11,860.05	2,451.17	5,598.13
10	19,965.43	11,906.58	2,452.80	5,606.05
11	19,948.78	11,902.45	2,446.98	5,599.35
12	14,805.68	8,810.48	1,819.88	4,175.32
Average	19,434.56	11,581.98	2,388.52	5,464.05

Repeatability 1 IOPS – I/O Request Throughput Distribution Graph

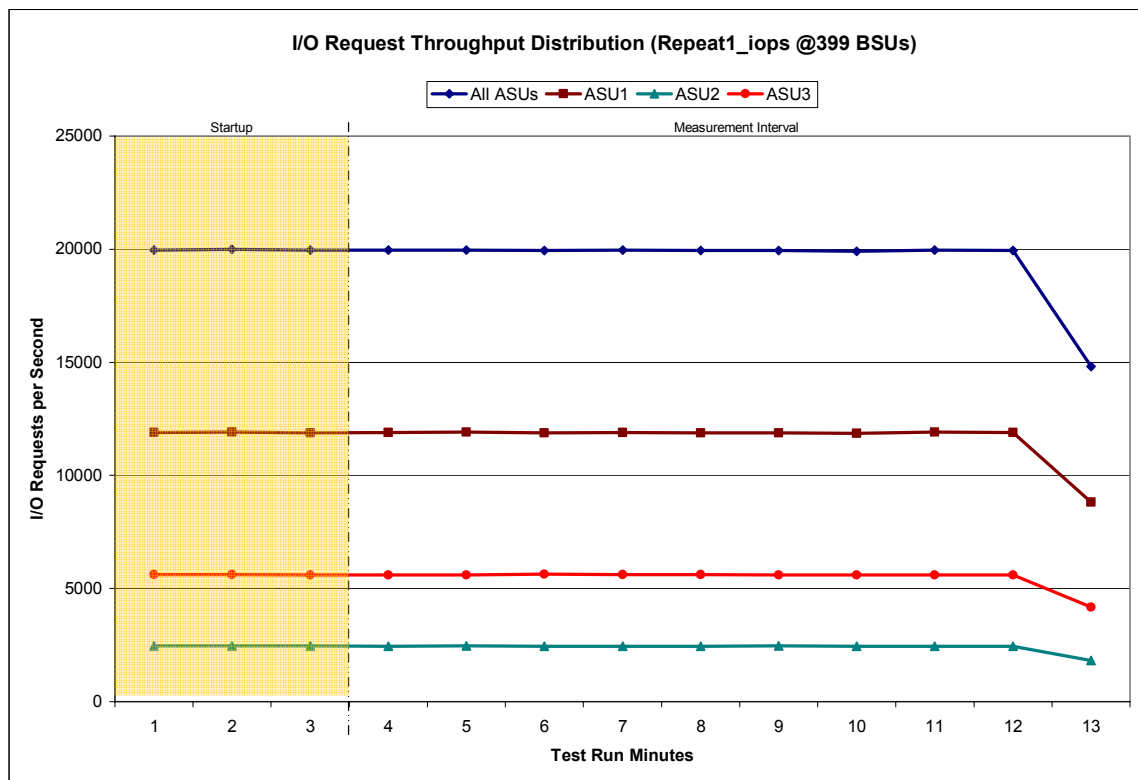

Repeatability 1 IOPS –Average Response Time (ms) Distribution Data

399 BSUs Start-Up/Ramp-Up Measurement Interval	Start 12:54:18	Stop 12:57:19	Interval 0-2	Duration 0:03:01
60 second intervals	All ASUs	ASU1	ASU2	ASU3
0	15.30	21.40	12.58	3.57
1	19.51	25.91	18.59	6.34
2	21.06	26.12	18.79	11.32
3	20.39	26.18	18.57	8.89
4	20.56	27.24	18.81	7.12
5	20.96	26.30	18.30	10.86
6	24.27	26.56	18.31	22.02
7	19.60	26.17	18.44	6.18
8	20.49	27.08	18.22	7.50
9	19.76	26.14	18.25	6.93
10	21.03	26.16	18.13	11.41
11	19.46	26.09	17.93	6.02
12	19.00	25.85	18.13	4.93
Average	20.55	26.38	18.31	9.19

Repeatability 1 IOPS –Average Response Time (ms) Distribution Graph

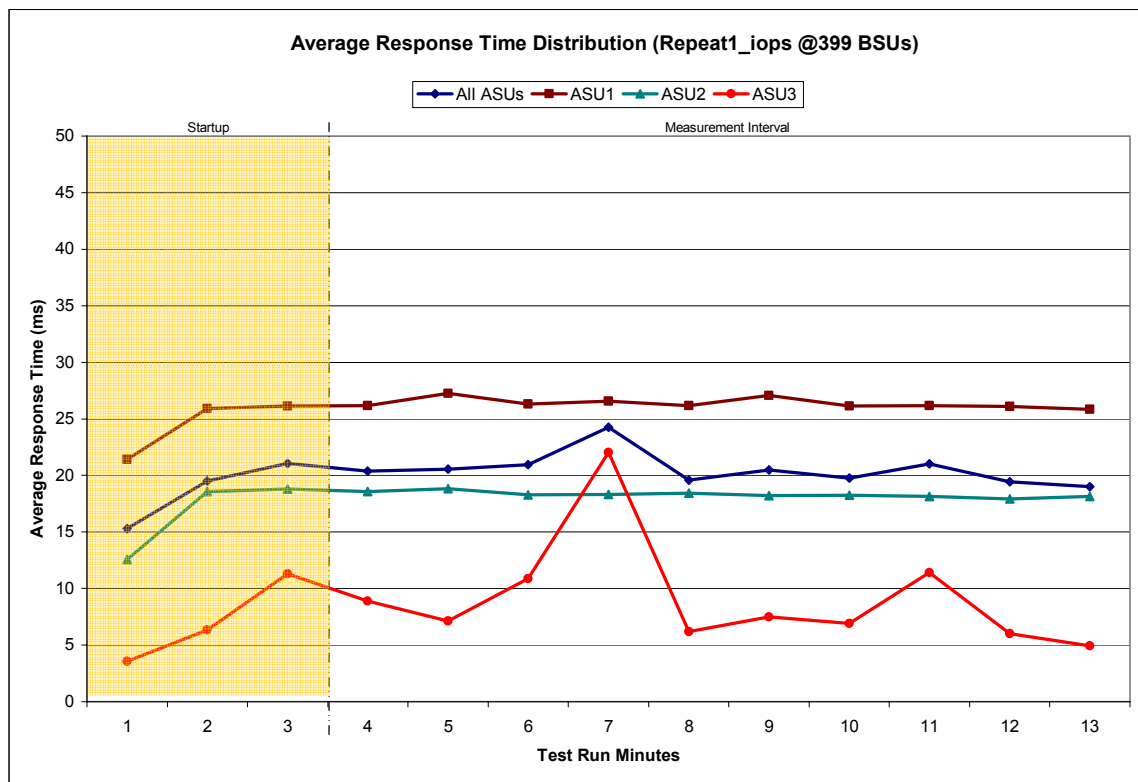

Repeatability 2 LRT – I/O Request Throughput Distribution Data

39 BSUs	Start	Stop	Interval	Duration
<i>Start-Up/Ramp-Up</i>	13:07:29	13:10:29	0-2	0:03:00
<i>Measurement Interval</i>	13:10:29	13:20:29	3-12	0:10:00
60 second intervals	All ASUs	ASU1	ASU2	ASU3
0	1,952.42	1,164.28	239.03	549.10
1	1,954.45	1,162.38	238.77	553.30
2	1,948.73	1,159.98	239.73	549.02
3	1,942.08	1,157.02	237.27	547.80
4	1,945.77	1,156.50	242.53	546.73
5	1,962.77	1,172.90	243.52	546.35
6	1,953.17	1,162.25	239.67	551.25
7	1,954.77	1,163.72	241.35	549.70
8	1,940.63	1,159.18	237.80	543.65
9	1,958.47	1,166.87	244.45	547.15
10	1,963.17	1,171.75	243.17	548.25
11	1,944.38	1,158.62	238.07	547.70
12	1,942.12	1,158.55	240.20	543.37
Average	1,950.73	1,162.74	240.80	547.20

Repeatability 2 LRT – I/O Request Throughput Distribution Graph

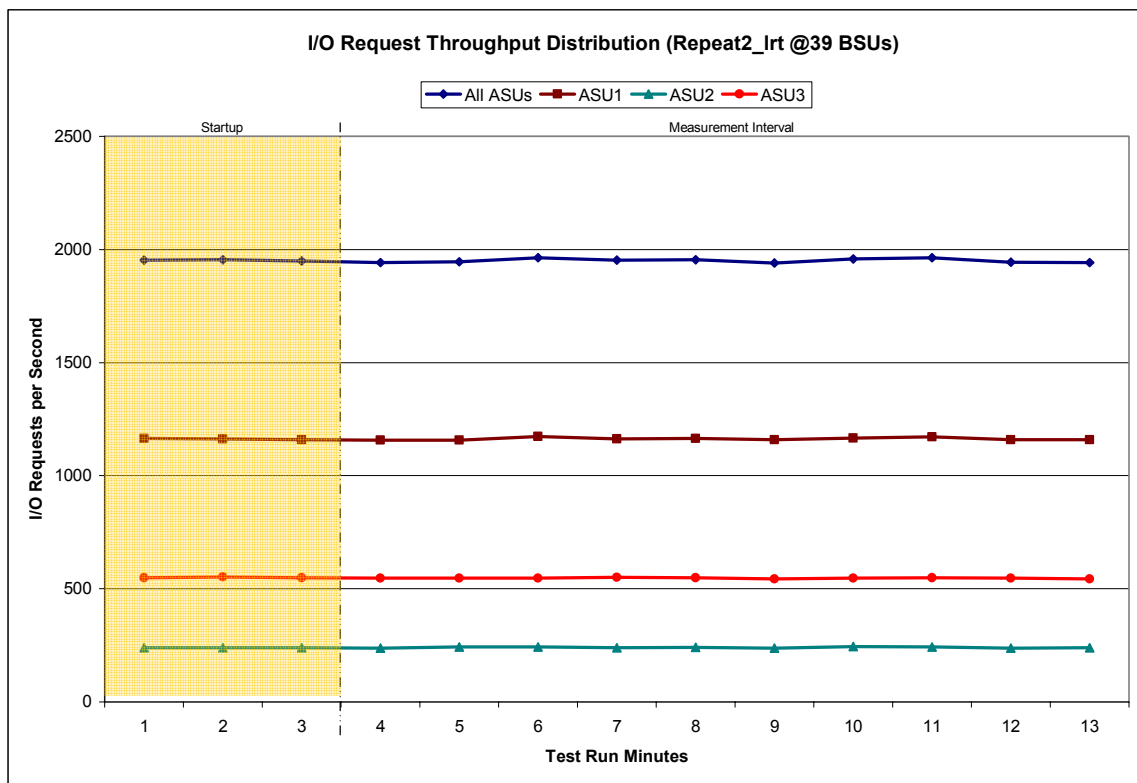

Repeatability 2 LRT –Average Response Time (ms) Distribution Data

39 BSUs	Start	Stop	Interval	Duration
<i>Start-Up/Ramp-Up</i>	13:07:29	13:10:29	0-2	0:03:00
<i>Measurement Interval</i>	13:10:29	13:20:29	3-12	0:10:00
60 second intervals	All ASUs	ASU1	ASU2	ASU3
0	2.79	3.61	4.08	0.50
1	2.65	3.63	2.86	0.50
2	2.66	3.64	2.88	0.49
3	2.64	3.63	2.75	0.50
4	2.65	3.62	2.84	0.49
5	2.68	3.65	2.87	0.50
6	2.62	3.58	2.82	0.50
7	2.64	3.62	2.79	0.50
8	2.71	3.65	2.91	0.62
9	2.67	3.65	2.80	0.52
10	2.72	3.64	2.96	0.63
11	2.69	3.64	2.83	0.62
12	2.69	3.64	2.84	0.60
Average	2.67	3.63	2.84	0.55

Repeatability 2 LRT –Average Response Time (ms) Distribution Graph

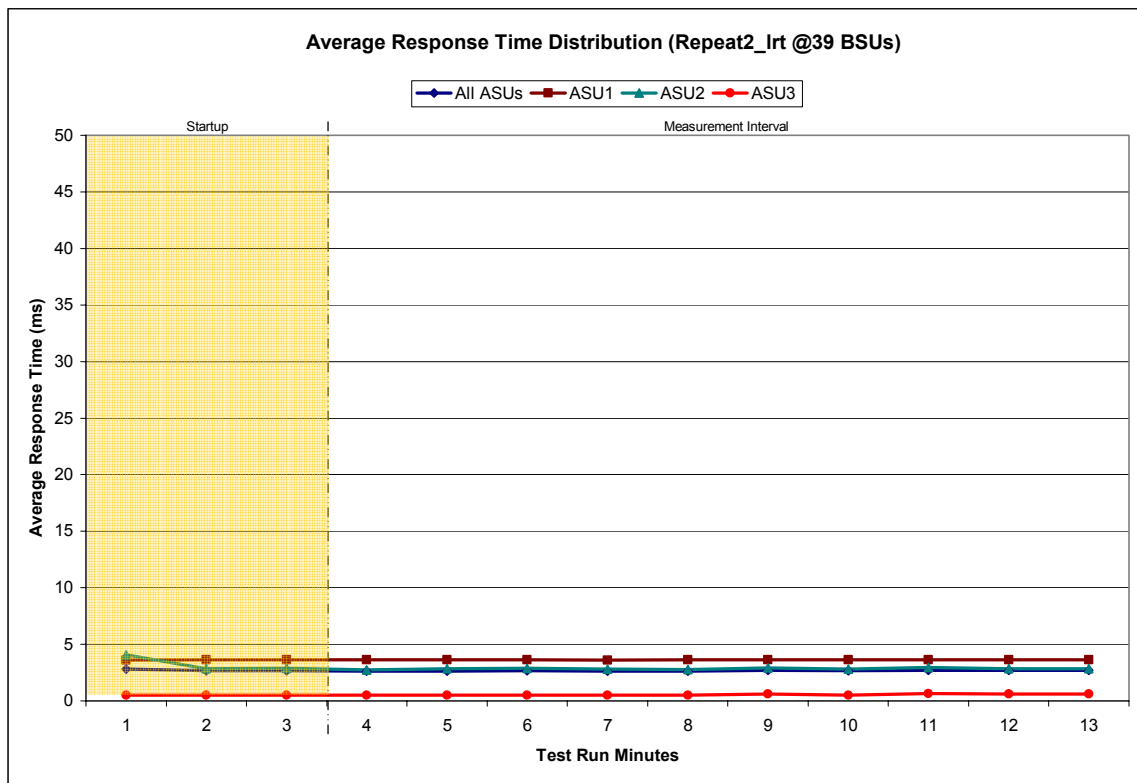

Repeatability 2 IOPS – I/O Request Throughput Distribution Data

399 BSUs				
	Start	Stop	Interval	Duration
<i>Start-Up/Ramp-Up</i>	13:20:34	13:23:35	0-2	0:03:01
<i>Measurement Interval</i>	13:23:35	13:33:35	3-12	0:10:00
60 second intervals	All ASUs	ASU1	ASU2	ASU3
0	19,958.03	11,907.42	2,452.32	5,598.30
1	19,950.80	11,885.88	2,456.85	5,608.07
2	19,910.13	11,863.92	2,453.18	5,593.03
3	19,937.73	11,882.55	2,456.67	5,598.52
4	19,953.33	11,882.70	2,452.27	5,618.37
5	19,931.37	11,869.65	2,453.48	5,608.23
6	19,963.33	11,900.12	2,461.98	5,601.23
7	19,959.72	11,905.98	2,455.78	5,597.95
8	19,963.48	11,886.28	2,456.35	5,620.85
9	19,942.75	11,899.63	2,447.43	5,595.68
10	19,964.07	11,891.80	2,461.78	5,610.48
11	19,993.92	11,914.73	2,461.35	5,617.83
12	17,253.55	10,288.62	2,112.88	4,852.05
Average	19,686.33	11,732.21	2,422.00	5,532.12

Repeatability 2 IOPS – I/O Request Throughput Distribution Graph

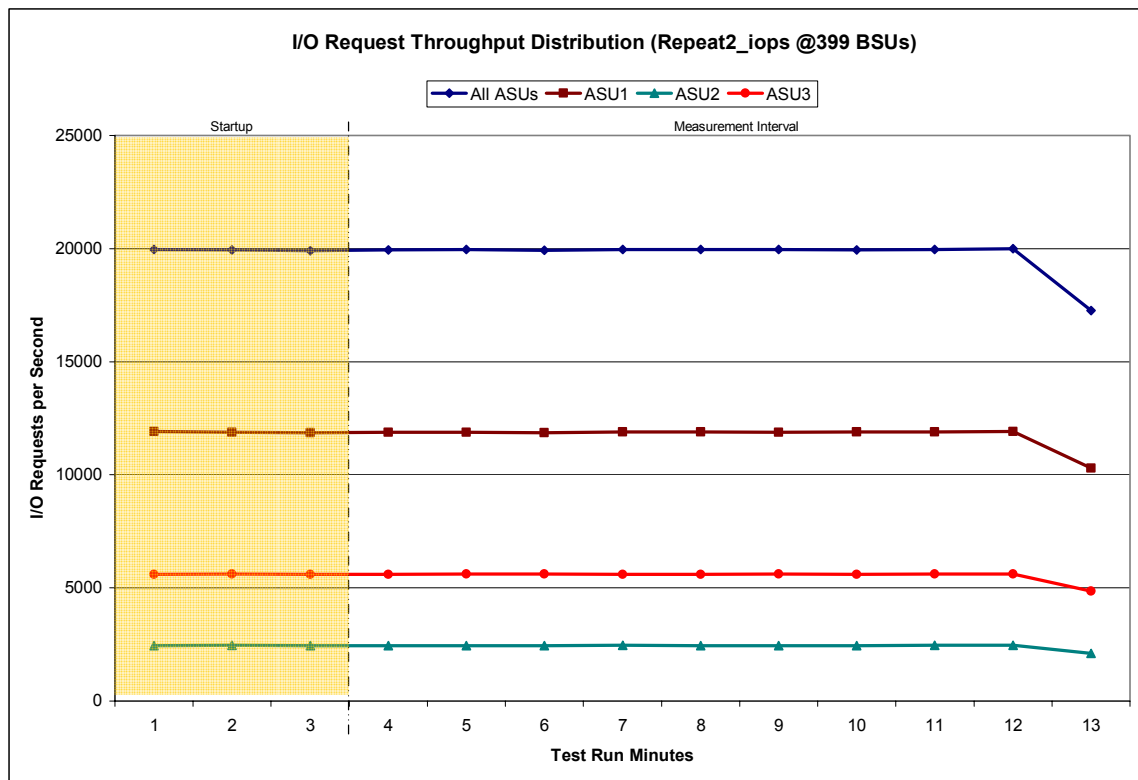

Repeatability 2 IOPS –Average Response Time (ms) Distribution Data

399 BSUs Start-Up/Ramp-Up Measurement Interval	Start 13:20:34 13:23:35	Stop 13:23:35 13:33:35	Interval 0-2 3-12	Duration 0:03:01 0:10:00
60 second intervals	All ASUs	ASU1	ASU2	ASU3
0	16.34	21.77	12.77	6.34
1	18.29	25.09	18.46	3.82
2	19.05	25.60	18.58	5.37
3	19.31	26.05	18.53	5.33
4	19.18	25.92	18.76	5.11
5	20.62	26.36	18.88	9.21
6	40.16	60.46	18.78	6.43
7	20.39	26.93	19.02	7.09
8	20.29	26.06	18.72	8.77
9	20.63	26.20	18.81	9.59
10	19.03	25.86	18.65	4.71
11	19.99	26.31	18.47	7.25
12	19.22	26.26	17.95	4.86
Average	21.88	29.64	18.66	6.84

Repeatability 2 IOPS –Average Response Time (ms) Distribution Graph

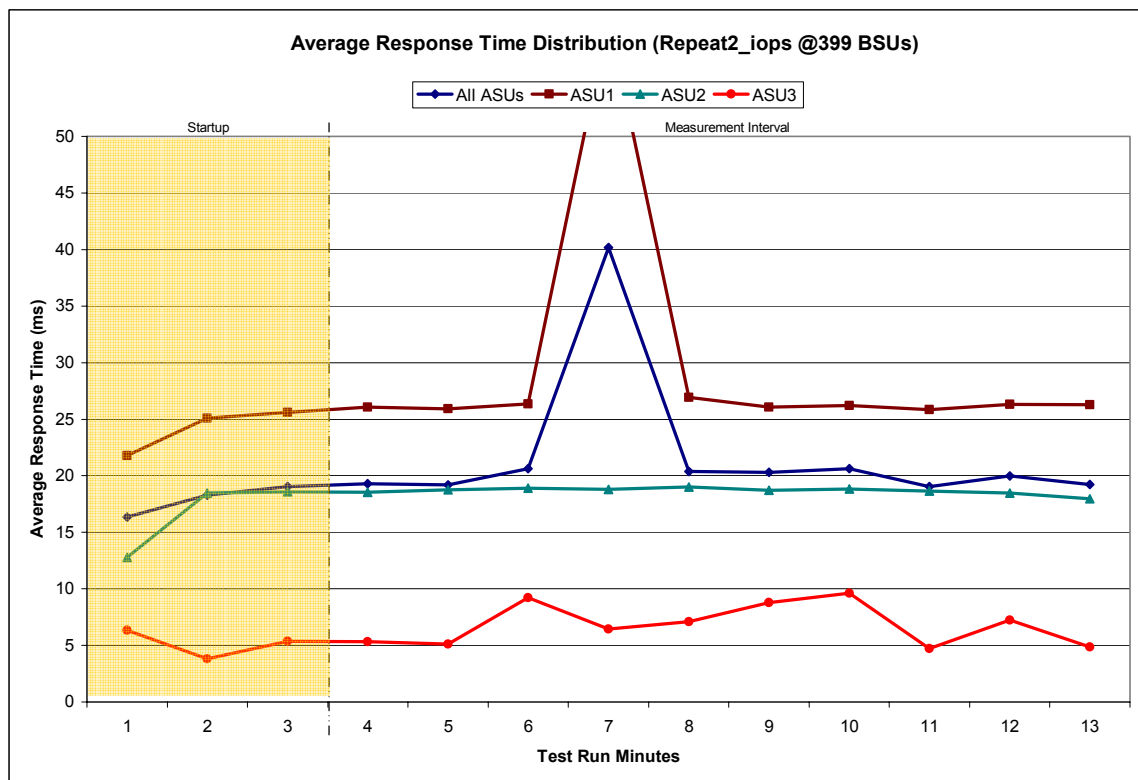

Repeatability 1 (LRT)

Measured Intensity Multiplier and Coefficient of Variation

	ASU1-1	ASU1-2	ASU1-3	ASU1-4	ASU2-1	ASU2-2	ASU2-3	ASU3-1
IM	0.0350	0.2810	0.0700	0.2100	0.0180	0.0700	0.0350	0.2810
MIM	0.0350	0.2816	0.0696	0.2098	0.0181	0.0699	0.0348	0.2812
COV	0.009	0.005	0.007	0.006	0.017	0.009	0.020	0.004

IM – Intensity Multiplier: The ratio of I/Os for each I/O stream relative to the total I/Os for all I/O streams (ASU1-1 – ASU3-1) as required by the benchmark specification.

MIM – Measured Intensity Multiplier: The Measured Intensity Multiplier represents the ratio of measured I/Os for each I/O stream relative to the total I/Os measured for all I/O streams (ASU1-1 – ASU3-1). This value may differ from the corresponding Expected Intensity Multiplier by no more than 5%.

COV – Coefficient of Variation: This measure of variation for the Measured Intensity Multiplier cannot exceed 0.2.

Repeatability 1 (IOPS)

Measured Intensity Multiplier and Coefficient of Variation

	ASU1-1	ASU1-2	ASU1-3	ASU1-4	ASU2-1	ASU2-2	ASU2-3	ASU3-1
IM	0.0350	0.2810	0.0700	0.2100	0.0180	0.0700	0.0350	0.2810
MIM	0.0350	0.2811	0.0700	0.2099	0.0180	0.0699	0.0350	0.2812
COV	0.007	0.001	0.003	0.002	0.004	0.003	0.005	0.002

Repeatability 2 (LRT)

Measured Intensity Multiplier and Coefficient of Variation

	ASU1-1	ASU1-2	ASU1-3	ASU1-4	ASU2-1	ASU2-2	ASU2-3	ASU3-1
IM	0.0350	0.2810	0.0700	0.2100	0.0180	0.0700	0.0350	0.2810
MIM	0.0349	0.2812	0.0701	0.2098	0.0179	0.0704	0.0351	0.2805
COV	0.017	0.003	0.011	0.005	0.020	0.010	0.012	0.005

Repeatability 2 (IOPS)

Measured Intensity Multiplier and Coefficient of Variation

	ASU1-1	ASU1-2	ASU1-3	ASU1-4	ASU2-1	ASU2-2	ASU2-3	ASU3-1
IM	0.0350	0.2810	0.0700	0.2100	0.0180	0.0700	0.0350	0.2810
MIM	0.0350	0.2810	0.0700	0.2100	0.0180	0.0700	0.0350	0.2810
COV	0.006	0.002	0.003	0.002	0.005	0.003	0.006	0.001

Data Persistence Test

Clause 6

The Data Persistence Test demonstrates the Tested Storage Configuration (TSC):

- *Is capable of maintain data integrity across a power cycle.*
- *Ensures the transfer of data between Logical Volumes and host systems occurs without corruption or loss.*

The SPC-1 Workload Generator will write 16 block I/O requests at random over the total Addressable Storage Capacity of the TSC for ten (10) minutes at a minimum of 25% of the load used to generate the SPC-1 IOP™ primary metric. The bit pattern selected to be written to each block as well as the address of the block will be retained in a log file.

The Benchmark Configuration will be shutdown and restarted using a power off/power on cycle at the end of the above sequence of write operations. In addition, any caches employing battery backup must be flushed/emptied.

The SPC-1 Workload Generator will then use the above log file to verify each block written contains the correct bit pattern.

Clause 9.2.4.8

The following content shall appear in this section of the FDR:

1. *A listing or screen image of all input parameters supplied to the Workload Generator.*
2. *For the successful Data Persistence Test Run, able illustrating key results. The content, appearance, and format of this table are specified in Table 9-12. Information displayed in this table shall be obtained from the Test Run Results File referenced below in #3.*
3. *For the successful Data Persistence Test Run, the human readable Test Run Results File produced by the Workload Generator.*

SPC-1 Workload Generator Input Parameters

The SPC-1 Workload Generator input parameters for the Data Persistence Test are listed below:

java persist1 -b 399

java persist2

Data Persistence Test Results File

A link to each test result file generated from each Data Persistence Test is listed below.

[Persistence 1 Test Results File](#)

[Persistence 2 Test Results File](#)

Data Persistence Test Results

Data Persistence Test Results	
Data Persistence Test Run Number: 1	
Total Number of Logical Blocks Written	35,020,160
Total Number of Logical Blocks Verified	25,114,368
Total Number of Logical Blocks that Failed Verification	0
Time Duration for Writing Test Logical Blocks	10 minutes
Size in Bytes of each Logical Block	512
Number of Failed I/O Requests in the process of the Test	0

In some cases the same address was the target of multiple writes, which resulted in more Logical Blocks Written than Logical Blocks Verified. In the case of multiple writes to the same address, the pattern written and verified must be associated with the last write to that address.

PRICED STORAGE CONFIGURATION AVAILABILITY DATE

Clause 9.2.4.9

The committed delivery data for general availability (Availability Date) of all products that comprise the Priced Storage Configuration must be reported. When the Priced Storage Configuration includes products or components with different availability dates, the reported Availability Date must be the date at which all components are committed to be available.

The FDR shall state: "The Priced Storage Configuration, as documented in this Full Disclosure Report will be available for shipment to customers on MMMM DD, YYYY." Where Priced Storage Configuration is the TSC Configuration Name as described in Clause 9.2.4.3.3 and MMMM is the alphanumeric month, DD is the numeric day, and YYYY is the numeric year of the date that the Priced Storage Configuration, as documented, is available for shipment to customers as described above.

The DataCore SANmelody™ Disk Server, as documented in this Full Disclosure Report became available for customer purchase and shipment on March 8, 2004.

PRICING INFORMATION

Clause 9.2.4.11

A statement of the respective calculations for pricing must be included.

Pricing information may found in the Tested Storage Configuration Pricing section on page 12.

ANOMALIES OR IRREGULARITIES

Clause 9.2.4.10

The FDR shall include a clear and complete description of any anomalies or irregularities encountered in the course of executing the SPC-1 benchmark that may in any way call into question the accuracy, verifiability, or authenticity of information published in this FDR.

There were no anomalies or irregularities encountered during the SPC-1 Onsite Audit of the DataCore SANmelody™ Disk Server.

APPENDIX A: CUSTOMER TUNABLE PARAMETERS AND OPTIONS

HKLM/CurrentControlSet/System/Services/DCSCache/Parameters

AllowRewrite

Default = (not present)
SPC-1 = 1

HashTableSize

Default =
SPC1 = 100000

IoQueueSize

Default =
SPC-1 = 200000

IoQueueCount

Default =
SPC-1 = 80

ReadAhead

Default = 1
SPC-1 = C000

ReadAheadCount

Default = (not present)
SPC-1 = 2328

WriteRequeue

Default = (not present)
SPC-1 = 1

WriteSizeStop

Default =
SPC-1 = 100000

HKLM/CurrentControlSet/System/Services/DCSPoll/Parameters

HighWaterMarkPercentage

Default = 28
SPC-1 = 2

LowWaterMarkPercentage

Default = A
SPC-1 = 0

MaxPollers

Default = (not present)
SPC-1 = 3

HKLM/CurrentControlSet/System/Services/DCSSp/Parameters

LunQueueDepth

Default = 100
SPC-1 = 50

HKLM/CurrentControlSet/System/Services/DCSSp/Parameters/210000E08B11951B

LunDistribution

Default = 0

SPC-1 = 1

HKLM/CurrentControlSet/System/Services/DCSSp/Parameters/210100E08B31951B

LunDistribution

Default = 0

SPC-1 = 1

Note: All values for server are given in hex unless otherwise stated

Host System FC Settings

FC Port for ASU1_1P and ASU1_2P

Execution Throttle

Default = 16

SPC-1 = 256

FC Port for ASU1_1M and ASU1_2M

Execution Throttle

Default = 16

SPC-1 = 256

FC Port for ASU2P and ASU2M

Execution Throttle

Default = 16

SPC-1 = 128

FC Port for ASU3P and ASU3M

Execution Throttle

Default = 16

SPC-1 = 256

Note: All values for hosts are given in decimal unless otherwise stated

APPENDIX B: TESTED STORAGE CONFIGURATION (TSC) CREATION

Storage Pool Creation

The screenshot below shows the NMV (network managed volume) snap-in. This is where pools are created from the attached storage devices and the SANmelody™ server creates logical volumes from the pool.

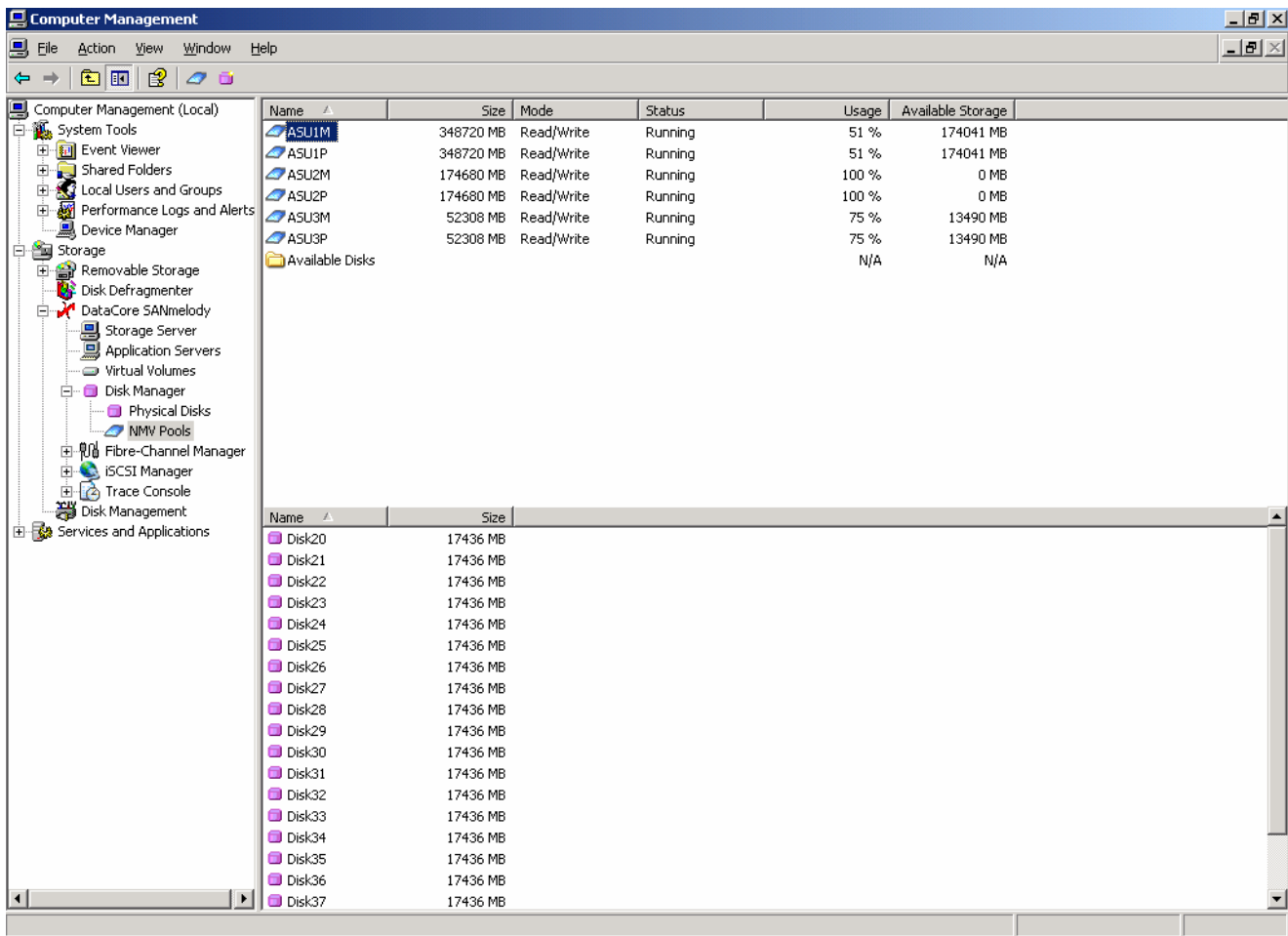

Pre-Allocated Logical Volume Creation

The DataCore Network Managed Volumes (NMVs) used in this benchmark utilized the “static physical allocation” option (auto-provisioning). All of the logical volumes assigned to ASU-1, ASU-2, and ASU-3 were backed by statically assigned physical storage. The ability to statically allocate the physical storage to logical volumes is an advanced feature of DataCore NMVs.

When each logical volume is created, its maximum size is specified to the Network Managed Volume subsystem in 512 byte blocks. That value is then used to assign that amount of physical storage for the logical volume. No subsequent physical storage allocation takes place for the logical volume.

The next screenshot displays the command line to create pre-allocated logical volumes. The appropriate pool is selected and a logical volume of the desired size is created (*option 5 from the above menu*). In the example screenshot below, a 1 virtual volume is created and pre-allocated with 1,073,741.824 bytes (2,097,152 512-byte blocks) of physical storage.



```
CA Shortcut to VLVTest.exe
nd mode is PoolReadWrite
6. StoragePool ID is 73d68d8c-7dd6-11d8-aa1a-505054503030 and state is Running a
nd mode is PoolReadWrite
Enter Pool to be opened: 3
StoragePool ID 53915992-46c3-11d8-be20-505054503030 is opened successfully
*****
*          Very Large Volume POOL Menu          *
*-----*
* 1. List Assigned Physical Disks.              *
* 2. List Available Physical Disks.             *
* 3. Add a Physical Disk.                      *
* 4. Remove a Physical Volume.                 *
* 5. Create a Virtual Volume.                  *
* 6. Release a Virtual Volume.                *
* 7. List all Virtual Volumes.                *
* 8. Remove a Virtual Volume.                 *
* 9. Purge a Virtual Volume.                  *
* 10. Pool Statistics.                        *
* 11. Physical disk allocation statistics.     *
* 12. Pool physical disks statistics.         *
* 13. Pool NMU statistics.                   *
* 14. Switch physical disk preferred state.   *
* 15. Set WaterMark value.                   *
* 16. Set NMU quota.                         *
* 17. Clear NMU quota.                       *
* 18. Clear NMU quota list.                  *
* 19. EXIT                                   *
*****
Enter your choice: 5
Please input the virtual disk size in blocks, you can't exceed the pool default
NMU size.
If you input zero, the size will be the default of pool size.
2097152
A Virtual Disk created with ID = 25
*****
*          Very Large Volume POOL Menu          *
*-----*
* 1. List Assigned Physical Disks.              *
* 2. List Available Physical Disks.             *
* 3. Add a Physical Disk.                      *
* 4. Remove a Physical Volume.                 *
* 5. Create a Virtual Volume.                  *
* 6. Release a Virtual Volume.                *
* 7. List all Virtual Volumes.                *
* 8. Remove a Virtual Volume.                 *
* 9. Purge a Virtual Volume.                  *
* 10. Pool Statistics.                        *
* 11. Physical disk allocation statistics.     *
* 12. Pool physical disks statistics.         *
* 13. Pool NMU statistics.                   *
* 14. Switch physical disk preferred state.   *
* 15. Set WaterMark value.                   *
* 16. Set NMU quota.                         *
* 17. Clear NMU quota.                       *
* 18. Clear NMU quota list.                  *
* 19. EXIT                                   *
*****
Enter your choice: _
```

Storage Server – Logical Volume Availability

The Storage Server snap-in is illustrated below, which lists the logical volumes available to the SANmelody™ server. The default size of a NMV (Network Managed Volume) is 2 TB, but the snap-in does not reflect the actual size of pre-allocated volumes. During the creation of a virtual volume the pre-allocated size determines the amount of storage served to the SPC-1 Workload Generator, as illustrated in the next screenshot.

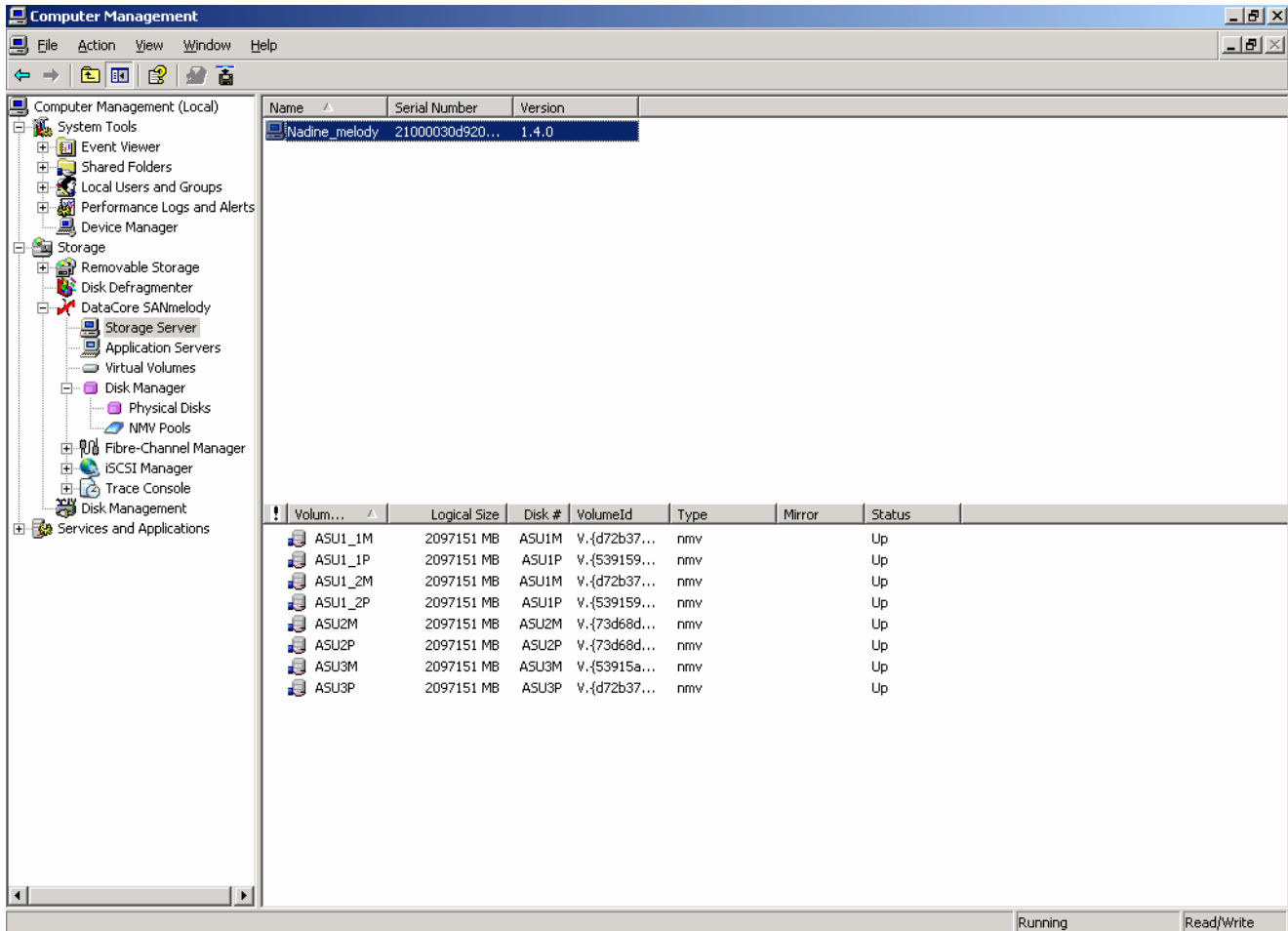

Virtual Volume Creation

The Virtual Volume snap-in, illustrated below, shows the logical volumes available to the SANmelody™ software and used to create virtual volumes for presentation to the SPC-1 Workload Generator. At this point, each virtual volume will be sized to match its pre-allocated size.

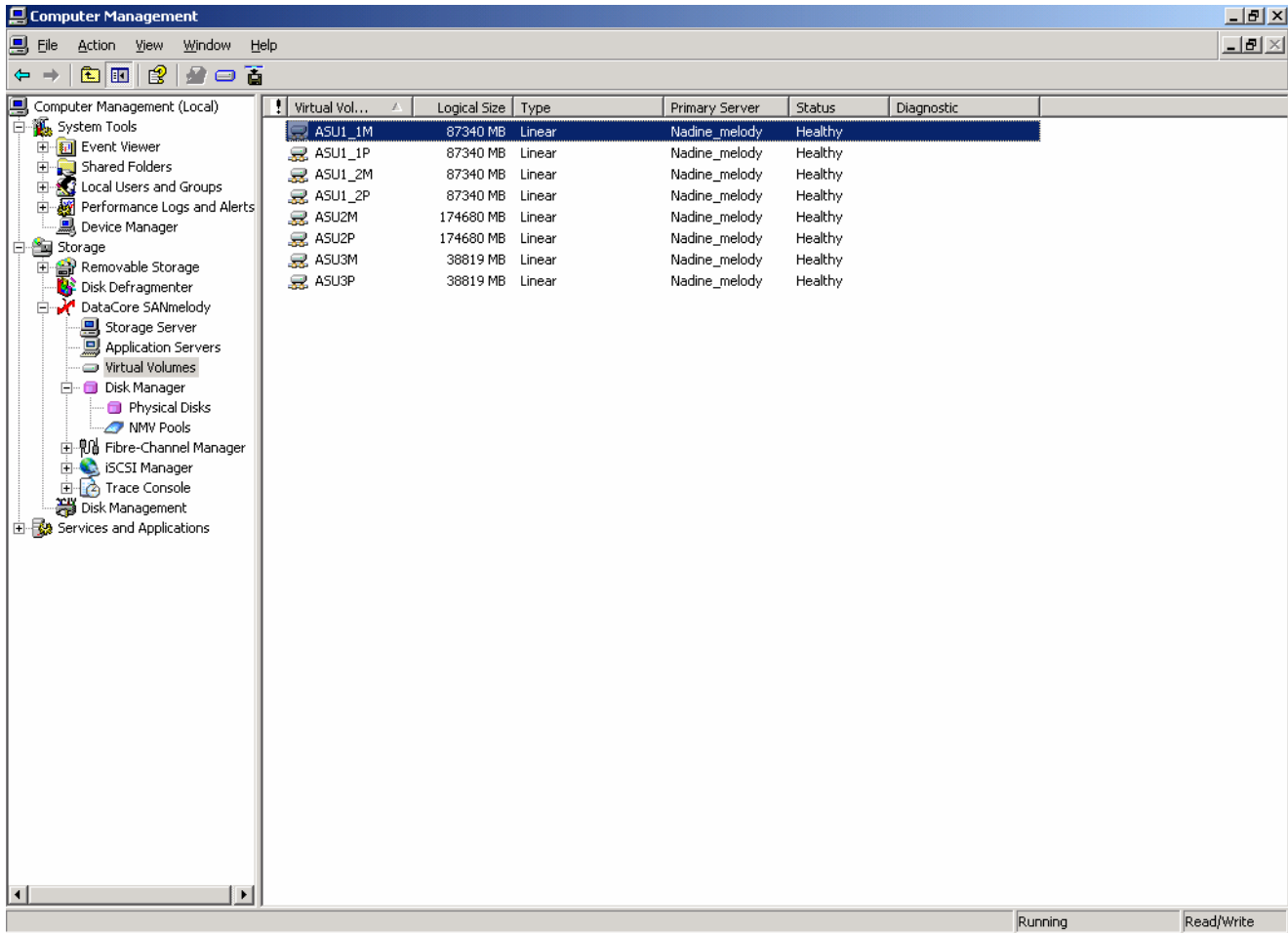

APPENDIX C: SPC-1 WORKLOAD GENERATOR STORAGE COMMANDS AND PARAMETERS

Master configuration file ("SPC1.cfg"):

```
javaparms="-Xmx512m -Xms512m -Xss128k"  
host=master  
slaves=(ex1,ex2,kronos1,kronos2)  
#  
sd=asu1_1,lun=\\.lw:  
sd=asu1_2,lun=\\.lx:  
sd=asu2_1,lun=\\.ly:  
sd=asu3_1,lun=\\.lz:
```

Slave configuration file ("*name.txt*"):

```
javaparms="-Xmx512m -Xms512m -Xss128k"  
host=ex1  
master=localhost  
#  
sd=asu1_1,lun=\\.lw:  
sd=asu1_2,lun=\\.lx:  
sd=asu2_1,lun=\\.ly:  
sd=asu3_1,lun=\\.lz:
```

Each Slave Host System used a SPC-1 configuration file identical to the above sample with the exception of substituting the appropriate "host" command line.

APPENDIX D: THIRD-PARTY PRICE QUOTATIONS

SC-1 – SANmelody™ Disk Server system:

The Dell Online Store Page 1 of 2

Close



Dell recommends Microsoft® Windows® XP Professional

Print Cart
Print This Page

Dell recommends Microsoft® Windows® XP Professional

Description

PowerEdge 2600
Date & Time: March 25, 2004 2:02:57 PM

SYSTEM COMPONENTS

Item	Description	Product Code	Qty	Unit Price	Total Price
*PowerEdge 2600	Intel® Xeon™ processor, 3.06GHz, 512 Cache, 533MHz Front Side Bus, Windows Server 2003 Standard Edition with 5 Client Licenses		1	\$5,374.00	
	Save \$400 on PowerEdge 2600 through the Small Business division. Special offer				-\$400.00
Catalog Number:	4				
Module	Description	Product Code	SKU	Id	
PowerEdge 2600	Intel® Xeon™ processor, 3.06GHz, 512 Cache, 533MHz Front Side Bus	26305	[221-2740]	1	
Operating System	Windows Server 2003 Standard Edition with 5 Client Licenses	W2K3SVR	[420-2965]	11	
Additional Processors	Intel® Xeon™ Processor, 3.06GHz, 512 Cache, 533MHz Front Side Bus	2P305	[311-2823]	2	
Memory	2GB DDR SDRAM (2X1GB)	2GB2D	[311-2735]	3	
Keyboard	NO KEYBOARD OPTION	N	[310-3281]	4	
Monitors	No Monitor Option	N	[320-0058]	5	
1st Hard Drive	36GB 10K RPM Ultra 320 SCSI Hard Drive	3610320	[340-6863]	8	
Floppy	3.5 in, 1.44MB, Floppy Drive	FD	[340-3640]	10	
Mouse	No Mouse Option	N	[310-0024]	12	
CD-ROM	24X IDE CD-ROM	CD24X	[313-1281]	16	
BackPlanes	1X6 Hot-Pluggable Backplane,PE2600	1X6BKPL	[311-1839]	18	
Documentation	Electronic Documentation,P2600	EDOCS	[310-0438]	21	
Factory Configurations	Drives attached to embedded SCSI controller, No RAID	MSN	[340-6468]	27	
Chassis Style	Tower Chassis Orientation,P2600 TOWER		[310-1720]	28	

http://ecom.dell.com/dellstore/PopUps/popup_print_cart.aspx?c=us&cs=04&l=en&s=bsd&itemtype=... 3/25/2004

The Dell Online Store Page 2 of 2

Hardware Support Services	3Yr SILVER Support, 4Hr Onsite, S/W Support	SILVERW	[950-0227] [960-4119] [902-4700] [902-3322]	29	
Installation Support Services	No Installation	NOINSTL	[900-9997]	32	
Power Supplies	Non-Redundant Power Supply,PE2600	NREDPWR	[310-1727]	36	
Purchase Intent	Purchase is not intended for resale.	NOT4SEL	[462-4506]	138	
TOTAL: \$4,974.00					
Total Price					
				Sub-total	\$4,974.00
				Shipping	--
				Tax	--
				Total Price	--

Copyright 1999-2004 Dell Inc. For customers of the 50 United States only.
Site Terms | Terms and Conditions of Sale | Privacy Policy

[^ Top](#)

HS-1 and 2 –Host Systems:

The Dell Online Store Page 1 of 2

Close



Dell recommends Microsoft® Windows® XP Professional

Print Cart
Print This Page

Dell recommends Microsoft® Windows® XP Professional

Description
PowerEdge 2600
Date & Time: March 30, 2004 10:05:16 AM

SYSTEM COMPONENTS

Module	Description	Product Code	Qty	Unit Price	Id
-PowerEdge 2600	Intel® Xeon™ processor, 3.06GHz, 512 Cache, 533MHz Front Side Bus, Windows Server 2003 Standard Edition with 5 Client Licenses		1	\$4,824.00	
	Save \$400 on PowerEdge 2600 through the Small Business division. Special offer			-\$400.00	
Catalog Number:	4				
PowerEdge 2600	Intel® Xeon™ processor, 3.06GHz, 512 Cache, 533MHz Front Side Bus	26305	[221-2740]		1
Operating System	Windows Server 2003 Standard Edition with 5 Client Licenses	W2K3SVR	[420-2965]		11
Additional Processors	Intel® Xeon™ Processor, 3.06GHz, 512 Cache, 533MHz Front Side Bus	2P305	[311-2823]		2
Memory	1GB DDR SDRAM (2X512MB)	1GB2D	[311-2732]		3
Keyboard	Standard Windows Keyboard, Gray	S	[310-1676]		4
Monitors	No Monitor Option	N	[320-0058]		5
1st Hard Drive	36GB 10K RPM Ultra 320 SCSI Hard Drive	3610320	[340-6863]		8
Floppy	3.5 in, 1.44MB, Floppy Drive	FD	[340-3640]		10
Mouse	Logitech Mouse, Gray	L	[310-3776]		12
CD-ROM	24X IDE CD-ROM	CD24X	[313-1281]		16
BackPlanes	1X6 Hot-Pluggable Backplane, PE2600	1X6BKPL	[311-1839]		18
Documentation	Electronic Documentation, P2600	EDOCS	[310-0438]		21
Factory Configurations	Drives attached to embedded SCSI controller, No RAID	MSN	[340-6468]		27

http://ecom.dell.com/dellstore/PopUps/popup_print_cart.aspx?c=us&cs=04&l=en&s=bs... 3/30/2004

The Dell Online Store Page 2 of 2

Chassis Style	Tower Chassis Orientation, P2600 TOWER	[310-1720]	28
Hardware Support Services	3Yr SILVER Support, 4Hr Onsite, S/W Support	SILVERW [950-0227] [960-4119] [902-4700] [902-3322]	29
Installation Support Services	No Installation	NOINSTL [900-9997]	32
Power Supplies	Non-Redundant Power Supply, PE2600	NREDPWR [310-1727]	36
Purchase Intent	Purchase is not intended for resale.	NOT4SEL [462-4506]	138
TOTAL: \$4,424.00			
Total Price			
Sub-total			\$4,424.00
Shipping			--
Tax			--
Total Price			--

Copyright 1999-2004 Dell Inc. For customers of the 50 United States only.
Site Terms | Terms and Conditions of Sale | Privacy Policy ^ Top

Qlogic QLA2344 HBAs:

Edward Ronga

From: Lisa Winchell [lwinchell@uni.memec.com]
Sent: Monday, March 08, 2004 10:46 AM
To: Hugh Humphreys; Edward Ronga
Cc: Kevin McClish
Subject: Qlogic quote

Importance: High

Hugh and Ed:

Unique is pleased to provide the following quotation. This price can be used by Datacore and provided to your end customers. If there are any problems, please let me know.

Qlogic part number QLA2344-BK

Unit Price: \$ 2959.00

Delivery: currently 130 pcs in Unique stock; standard leadtime is 90 days ARO

Thank you for the opportunity to quote.

Lisa Winchell
Area Account Manager
Unique Technologies
Fort Lauderdale, FL
954-270-8662 Cell
lwinchell@uni.memec.com
<http://www.unique.na.memec.com>

Franchised Distributor for Actel * Agere * C&D Technologies * E2O * Ericsson * Fujitsu * GSI Technology * Hifn * IBM * ICS* Intersil * Marvell *M-Systems* Memec Design* Oki Semiconductor * PMC Sierra * Power Integrations * Qlogic * Semtech * SMSC * SST * Tyco Power Systems * Ubicom *Wind River* Xicor

Qlogic QLA2342 HBA:

Message Page 1 of 1

Edward Ronga

From: 9 TO 5 COMPUTER [kraab@9to5computer.com]
Sent: Tuesday, March 23, 2004 1:58 PM
To: Edward Ronga
Subject: qla2342

qty2
qla2342
new/bulk 60day warranty
\$1500.00ea

Kevin Raab
1548 The Greens Way
Jacksonville Beach, FL 32250
ph #904-280-2544
fx #904-280-2524
im:kevraab33

Qlogic QLA2340 HBA:

Shopping Cart
Page 1 of

[HOME](#)

[APC REPLACEMENT BATTERIES/BATTERY BACK-UPS](#)

[ARTS PDF & ENFOCUS SOFTWARE](#)

[CISCO SYSTEMS](#)

[COMPAQ HARD DRIVES/TAPE DRIVES](#)

[COMPAQ CONTROLLERS/SWITCHES/MEMORY](#)

[DLT * LTO * SUPER DLT * AIT * MAMMOTH * 9840 * 3570](#)

[FIBRE/SCSI ADAPTERS ATTO/EMULEX/JNI/QLOGIC](#)

[GCC LASER PRINTERS/TONER](#)

[HARD DRIVE DUPLICATORS/DISK DRIVE DUPLICATORS](#)

[HARD DRIVES AND SUBSYSTEMS](#)

[HP LASERJET PRINTERS/FUSER UNITS](#)

[IOMEGA ZIP AND JAZ](#)

[JMR STORAGE SYSTEMS AND ENCLOSURES](#)

[LOGICUBE HARD DRIVE DUPLICATORS](#)

[MAGNETO OPTICAL DRIVES](#)

[MAGNETO OPTICAL DISKS](#)

[POWERLOGIX PROCESSOR UPGRADES](#)

[SOFTWARE & SUPPLES](#)

[SUN MICROSYSTEMS](#)

[TAPE DRIVES, LIBRARIES, AUTOLOADERS](#)

[UMAX PROFESSIONAL SCANNERS](#)

[XANTE LASER PRINTERS/SUPPLIES](#)

[X-RITE DENSITOMETERS](#)

STORAGESTOR

NEW! [Send to more than one address.](#) [What's This?](#)

Item	Unit Price	Quantity	Subtotal	
QLA2340-CK Qlogic Sanblade PCI/PCI-X	925.00	<input type="text" value="1"/>	925.00	Remove
QLA2342-CK QLOGIC SANBLADE PCI/PCI-X	1575.00	<input type="text" value="1"/>	1575.00	Remove
Subtotal for StorageStor			2500.00	

Update Quantities

Check Out

Express checkout with
YAHOO! WALLET

Keep Shopping

[SHOW ORDER](#)

[INFO](#)

[SEARCH](#)

[INDEX](#)

Y! SHOPPING

<http://order.store.yahoo.com/cgi-bin/wg-order?storagestor>
4/1/200

JMR 10Bay Fibre Channel Chassis:

Message Page 1 of 1

Edward Ronga

From: 9 TO 5 COMPUTER [kraab@9to5computer.com]
Sent: Tuesday, March 23, 2004 12:52 PM
To: Edward Ronga
Subject: jmr quotation

QTY7
FR10-F22-2S
\$2135.00ea
1-2 WEEK LEAD TIME ON ALL JMR ENCLOSURES
APPROX FREIGHT IS \$175 TO SOUTH FLORIDA

3yr factory warranty - spare parts are 1 year

Kevin Raab
1548 The Greens Way
Jacksonville Beach, Fl. 32250
ph #904-280-2544
fx #904-280-2524
im:kevraab33

Seagate ST318453FC 18.4 GB 15K RPM Disk Drive:

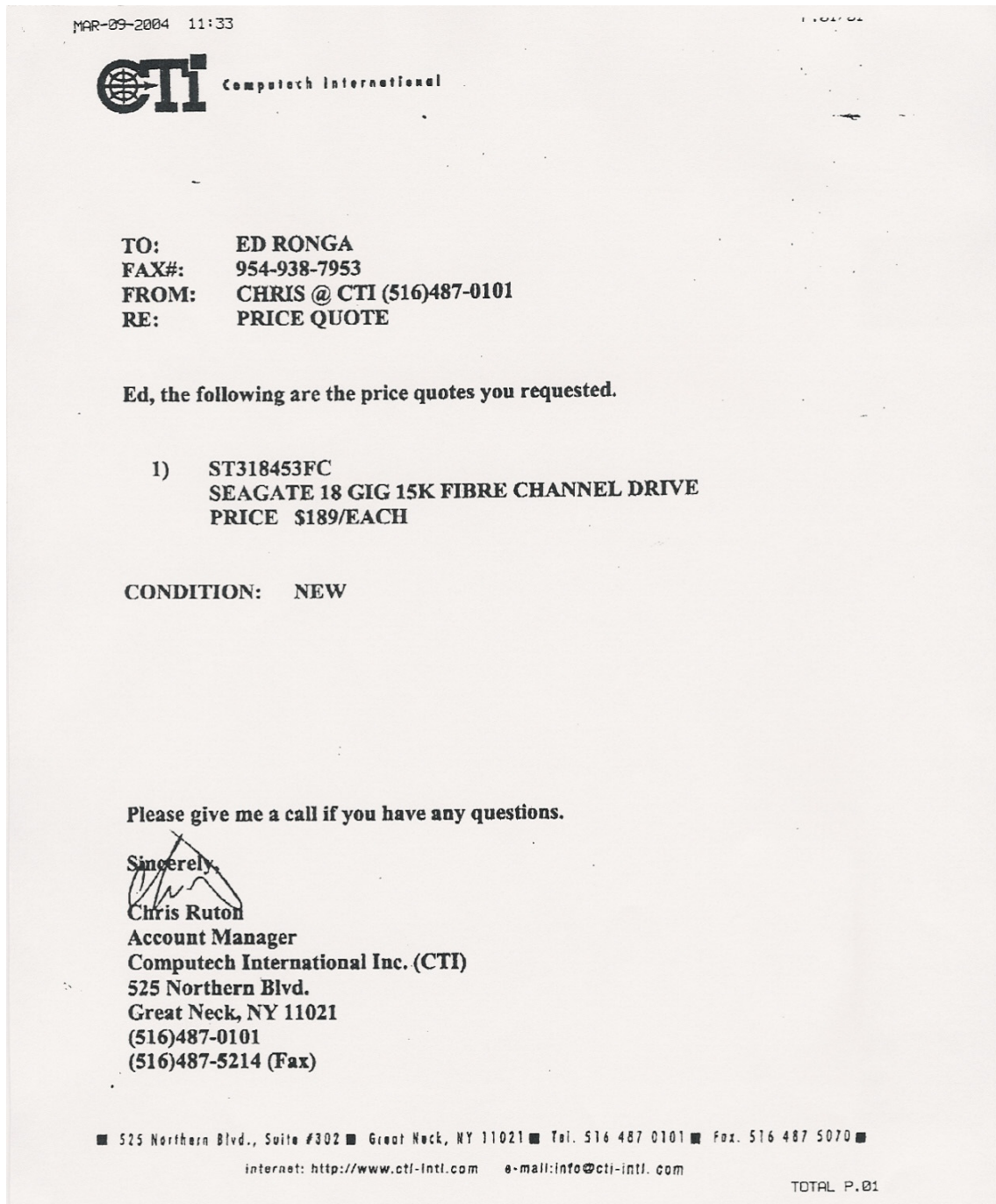

Seagate ST336753FCO 36.7 GB 15K RPM Disk Drive:

OCT 12 2002 10:47PM HP LASERJET 3200 P. 1
Page 1 of 1

3/5/2004 1:54:32 PM



**COMPUTER
GIANTS**

ComputerGiants.com Inc.
168 Madison Ave, 5th Floor
New York, NY 10016
Fax: 212-447-4489
Phone: 212-447-4487

QUOTATION

Bill To:

DATA CORE SOFTWARE
Attn : ED RONGA
6300 NW 5TH WAY
FORT LAUDERDALE, FL 33309
954 377 6052 : 954 377 6000 954 938 7953

Ship To:

DATA CORE SOFTWARE
Attn : ED RONGA
6300 NW 5TH WAY
FORT LAUDERDALE, FL 33309

Quote Date & Time	Order Status	E-mail
3/4/2004 11:14:44 AM	Quote	ERONGA@DATA CORESOFTWARE.COM

Quote Number	Sales Rep	Shipping Type	Terms
171852	matt	Ground	Net 30

Quantity	Item	Description	Unit Price	Total
40	ST336753FCO	SEAGATE 36.7GB FC 1 YR. WARR, 15000RPM 3.5 LOW PROFILE CHEETAH DISK DRIVE	\$255.00	\$10,200.00
			Subtotal	\$10,200.00
			Taxes	\$0.00
			Shipping	\$0.00
			Grand Total	\$10,200.00

Comments: 3/4/2004 : ENTER COMMENTS / SPECIAL INSTRUCTIONS HERE

Thank you for choosing Computer Giants.

Payment terms are always in advance unless otherwise specified in an agreement between buyer and ComputerGiants.com. All unpaid invoices shall bear interest at 1.12% of the outstanding balance per month, commencing on the payment due date. In the event that ComputerGiants.com must send a sales invoice to an attorney for collection, the buyer agrees to pay any and all costs associated with such collection, including, but not limited to, attorney's fee and cost incurred prior to during and after a trial, and including, but not limited to, collection, bankruptcy or other creditor's rights proceeding. All COD transactions are secure (Bank Check or Money Order) or with a Credit Card Authorization on a Company Check or Personal Check.

All International Orders are Prepayment Wire Transfer Company Check etc. No exceptions.
The Computer Industry has an inherent volatility in pricing. Prices are subject to change.

<http://www.cg2.net/quotation.asp>
3/5/2004

Fibre Media Interface Adaptor:

Purchase Order Preview Page 1 of 1

Order Preview **ICT**
.....

ICTcompany.com 800-772-5188 Thursday, March 25 2004, 13:

Search for:

(1 item)
 HACKER SA
TESTED DAILY 25-

Home > Order Preview > Buyer's Information > Shipping Method > Payment Method

BUY WITH CONFIDENCE - YOU CAN RETURN IT WITHIN 30 DAYS! NO RESTOCKING FEE.

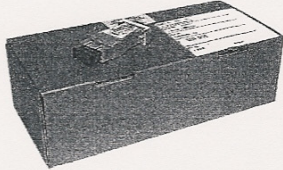

[Click here for product details](#)

ICT Part #: MDB-9-6-1

Manufact. Part#: MDB-9-6-1

Category : Fiber Optic Products

Availability : In stock

Quantity : 19

Weight : 5.4 lb.

Condition: **New White/Brown Retail Box**
This product is new in original single white/brown retail box with accessor

Item	Description	Price	Avail.Qty.	Qty.	Ext.Pric
MDB-9-6-1	MDB-9-6-1 Fiber Media Interface Adapter DB-9/SC (MIA Copper to Fiber) - New White/Brown Retail Box Contents: Fiber Media Interface Adapter	\$230.00	19	<input type="text" value="7"/>	\$1,610
TOTAL:					\$1,610

To calculate shipping charges, please enter **Destination Zip Code:**



If you wish to proceed to the next step to finalize an order, press the **Buy Now** button. Otherwise click on the **Continue Shopping** button to return to ICT Home page. You may adjust the quantities before ordering. Just enter a required quantity and then press the **Update Quantity** button.

If you wish to add more items to your order, click on the **Continue Shopping** button. If you do not wish to place an order at this time, click on the **Cancel Order** button.

30 Days Satisfaction Guarantee or your money back. Details in the [Terms and Condition](#)

Home | About | Trade | Contact | Support

Copyright © 1999-2003 ICT Company. All rights reserved. [Privacy Policy](#)

http://www.ictcompany.com/ver1/prod_est.asp?item=MDB-9-6-1
3/25/2004

LC to LC Multimode Duplex Fiber Optic Patch Cables:

GoCables: Basket Contents Page 1 of 2

[CAT5 PATCH CABLES](#) | [CISCO TYPE](#) | [COMPONENTS](#) | [COMPUTER](#) | [FIBRE CHANNEL](#) | [FIBER OPTICS](#) | [FIRE WIRE](#) | [IEEE-488](#) | [KVM Switches and Cables](#) | [LINE CORD](#) | [PRINTER](#) | [SCSI](#) | [USB](#)

GoCables [Account](#) [Search](#) [Shopping Cart](#) [Check Out](#) [Tell A Friend](#)

	Code	Product	Quantity	Price/Ea.	Total
Edit Remove	GCEFAZLL	LC to LC Multimode Duplex Fiber Optic Patch Cable	<input type="text" value="8"/> Update	\$50.98	\$407.84
		Cable Length: 5 meter Micron Size: 62.5µM			
				<i>Discount: GCEFAZLL (Qty: 8) (20%):</i>	<i>(\$81.57)</i>
				Total:	\$326.27

Order FAQ

How can I add to my order to avoid the handling fee?
From check out click SHOPPING CART to change the product quantity. To add another product; click on the category heading at the top of the page and add the new product to your cart.

Will products with different lead times be shipped separately?
No, all items will be held until order can be shipped complete. If separate shipments are requested there will be an additional shipping fee added to the order. Please contact the Customer Service office (562) 356-3140 for details.

How do I redeem a coupon?
Click Checkout Now and enter your Coupon on the Payment page in the space provided.
Note: Some Coupons cannot be combined and/or are good for one purchase only.

How do I remove items from my cart?
Click "Delete Item" next to the item you wish to remove.

How do I change the quantity of an item in my shopping cart?
Change the number in the box next to that item and click "Update Quantity".

How safe is my order?
We use the latest encryption technology. Each purchase you make is protected and safe. For more information please read our Safe Shopping Guarantee.

Why do I have to sign in?
Safe Shopping and Privacy are the two best reasons. It also makes shopping faster, lets you check your order status and helps provide a history of what you've bought.

No handling fee for net orders (after discounts) of \$20.00 or more. Normal shipping charges will be applied to every order.

[BACK](#) [Contact us](#)

http://www.gocables.com/Merchant2/merchant.mv? 3/30/2004

SC to LC Multimode Duplex Fiber Optic Patch Cables:

GoCables: Basket Contents Page 1 of 2

[CAT5 PATCH CABLES](#) | [CISCO TYPE](#) | [COMPONENTS](#) | [COMPUTER](#) | [FIBRE CHANNEL](#) | [FIBER OPTICS](#) | [FIRE WIRE](#) | [IEEE-488](#) | [KVM Switches and Cables](#) | [LINE CORD](#) | [PRINTER](#) | [SCSI](#) | [USB](#)

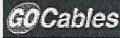
 [Account](#) [Search](#) [Shopping Cart](#) [Check Out](#) [Tell A Friend](#)

	Code	Product	Quantity	Price/Ea.	Total
Edit Remove	GCFAZCL	SC to LC Multimode Duplex Fiber Optic Patch Cable Cable Length: 5 meter Micron Size: 62.5µM	<input type="text" value="7"/> Update	\$40.42	\$282.94

Discount: GCFAZCL (Qty: 7) (20%): (\$56.59)
Total: \$226.35

Order FAQ

How can I add to my order to avoid the handling fee?
From check out click SHOPPING CART to change the product quantity. To add another product; click on the category heading at the top of the page and add the new product to your cart.

Will products with different lead times be shipped separately?
No, all items will be held until order can be shipped complete. If separate shipments are requested there will be an additional shipping fee added to the order. Please contact the Customer Service office (562) 356-3140 for details.

How do I redeem a coupon?
Click Checkout Now and enter your Coupon on the Payment page in the space provided.
Note: Some Coupons cannot be combined and/or are good for one purchase only.

How do I remove items from my cart?
Click "Delete Item" next to the item you wish to remove.

How do I change the quantity of an item in my shopping cart?
Change the number in the box next to that item and click "Update Quantity".

How safe is my order?
We use the latest encryption technology. Each purchase you make is protected and safe. For more information please read our Safe Shopping Guarantee.

Why do I have to sign in?
Safe Shopping and Privacy are the two best reasons. It also makes shopping faster, lets you check your order status and helps provide a history of what you've bought.

No handling fee for net orders (after discounts) of \$20.00 or more. Normal shipping charges will be applied to every order.

[BACK](#) [Contact us](#)

http://www.gocables.com/Merchant2/merchant.mv? 3/25/2004